

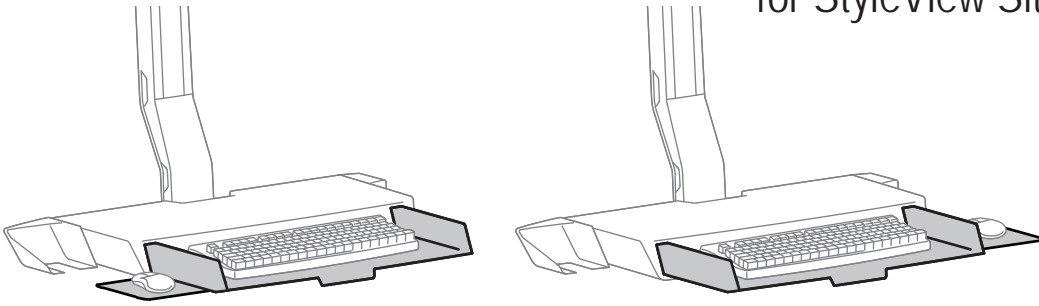

Mouse Tray

for StyleView Sit-Stand Combo Arm
with Worksurface

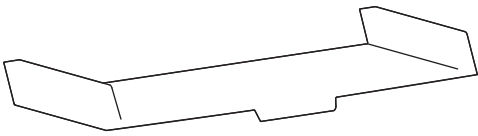

Components

	A	B
1	1x 	6x  M4 x 6 mm

Tools Needed

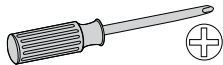

1 a

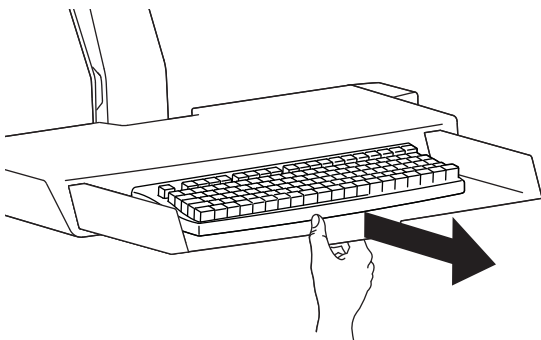

b

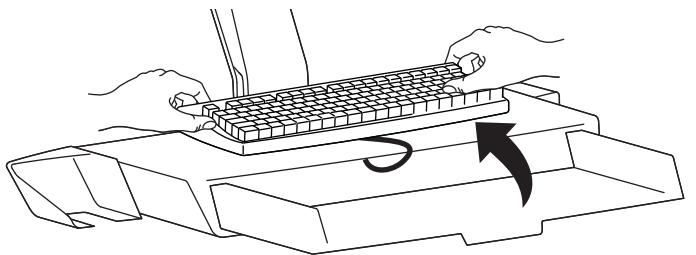

2

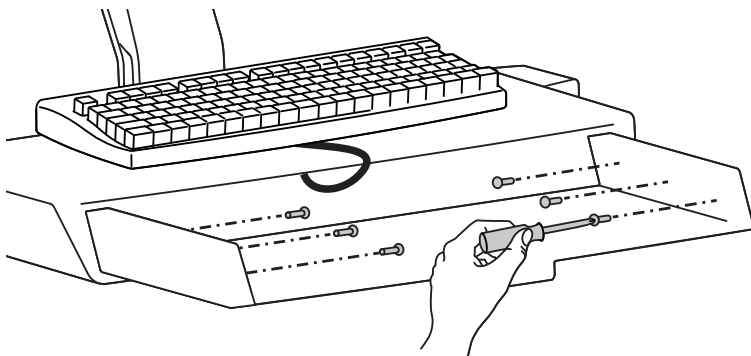

www.ergotron.com

USA 1-800-888-8458

Europe +31 (0)33-45 45 600

China 86-769-86018920

3 a

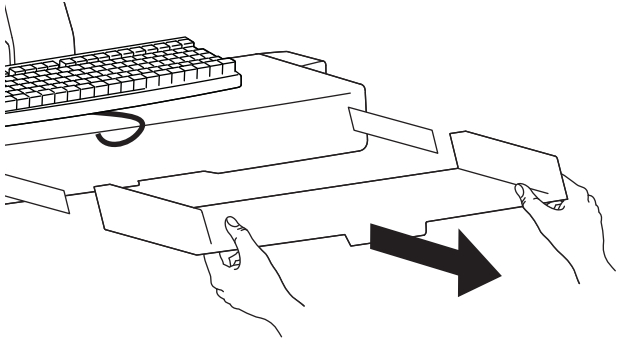

b

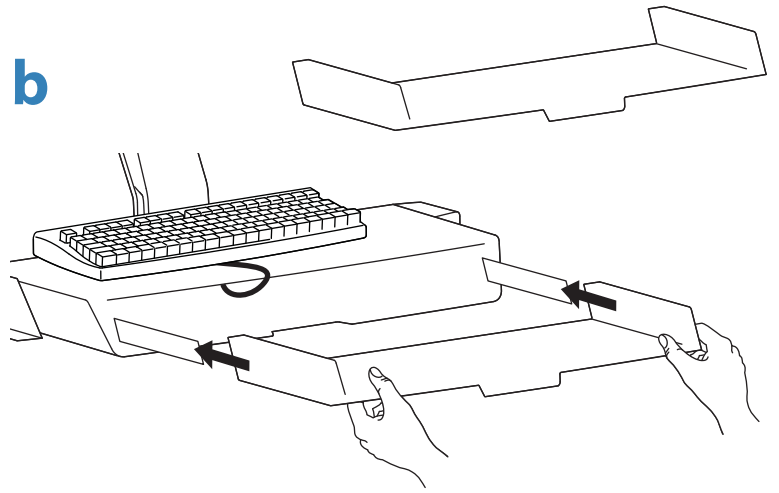

4

6x 
M4 x 6 mm

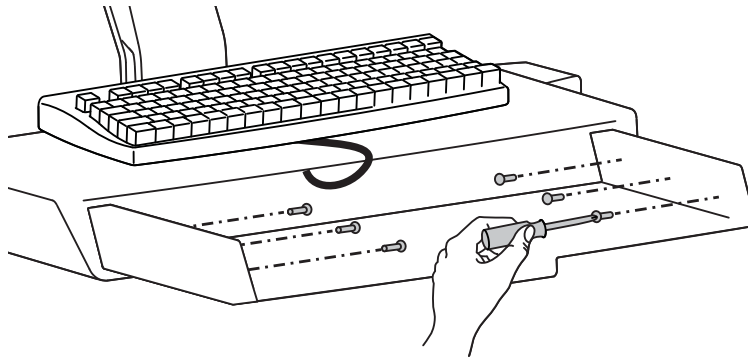

5

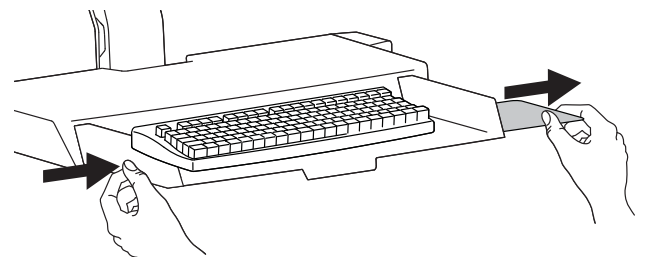
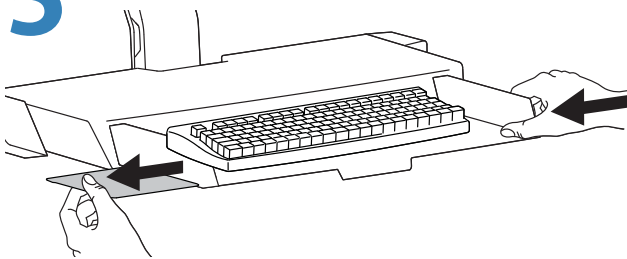

For local customer care phone numbers visit: <http://contact.ergotron.com>

For service and warranty visit www.ergotron.com

Si desea información de servicio y garantía, visite www.ergotron.com

Pour toute question concernant la garantie ou le service client, consultez www.ergotron.com

Weitere Informationen zu Service und Gewährleistung erhalten Sie unter www.ergotron.com.

Ga voor service en garantie naar www.ergotron.com

Per assistenza e la garanzia visitare www.ergotron.com

Gå in på www.ergotron.com för service och garanti

サービスおよび保証について詳しくは、www.ergotron.com をご覧ください。

有关服务和保修，请访问 www.ergotron.com



© 2013 Ergotron, Inc.
All rights reserved.

While Ergotron, Inc. makes every effort to provide accurate and complete information on the installation and use of its products, it will not be held liable for any editorial errors or omissions (including those made in the process of translation from English to another language), or for incidental, special or consequential damages of any nature resulting from furnishing this instruction and performance of equipment in connection with this instruction. Ergotron, Inc. reserves the right to make changes in the product design and/or product documentation without notification to its users. For the most current product information, or to know if this document is available in languages other than those herein, please contact Ergotron. No part of this publication may be reproduced, stored in a retrieval system, or transmitted in any form or by any means, electronic, mechanical, photocopying, recording or otherwise without the prior written consent of Ergotron, Inc., 1181 Trapp Road, Eagan, Minnesota, 55121, USA. Patents Pending and Patented U.S. & Foreign. Ergotron is a registered trademark of Ergotron, Inc.

Americas Sales and Corporate Headquarters

St. Paul, MN USA
(800) 888-8458
+1-651-681-7600
www.ergotron.com
sales@ergotron.com

EMEA Sales

Amersfoort, The Netherlands
+31 33 45 45 600
www.ergotron.com
info.eu@ergotron.com

APAC Sales

Tokyo, Japan
www.ergotron.com
apacustomerservice@ergotron.com

Worldwide OEM Sales

www.ergotron.com
info.oem@ergotron.com