

MONITOR ARM ACCESSORIES



POSITION ACCESSORIES TO KEEP YOUR FOCUS

As mobile computing and high resolution displays become more common, ideal placement of laptop and iPad® screens becomes even more critical. Often, the best screen in the office is the one on your laptop or tablet. Put them exactly where they belong — front and center — with the Workrite Laptop or iPad Holder. The Laptop Holder features adjustable side bars to allow access to side ports while keeping the laptop secure, venting for increased performance and adjustable depth to attach docking stations for a more productive work environment.

The iPad holders are available in a Quick Mount version for users on the go or a steel frame model for more secure tablet positioning. Get the full benefit of your Retina Display® by easily positioning the iPad at the ideal height for viewing or touch input.



With up to 14" depth, the Laptop Holder allows for large laptops and Docking Stations.



The iPad Holder mounts to the monitor arm for long-term tablet positioning.

MONITOR ARM ACCESSORIES

Products listed on this page are available through GSA Contract GS-28F-0030S SIN #711-2 (Schedule 71) except where noted



Not on GSA Contract

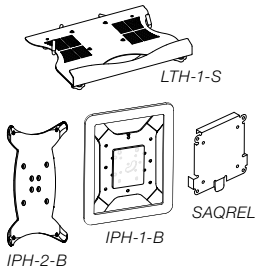

Laptop Holder features:

- Fits Willow single or dual monitor arms, ordered separately
- Accommodates most popular 13", 15" and 17" laptops measuring from 12"-16½"W x 8"-11"D
- Depth adjusts from 10" to 14" allowing use of docking stations
- Adjustable sidebars keep laptops from shifting
- Formed front edge with open area for touchpad controls
- Vented for cooling, steel with silver powdercoat finish

Quick Mount iPad Holder features:

- Quickly mount and release generation 2, 3 & 4 iPad to Willow monitor arms
- Black or gray plastic, single piece mount with "snap-in" corner mounting
- Camera lens hole in mount for rear camera use while mounted

iPad Holder features:

- Mount generation 2, 3 & 4 iPad to Willow monitor arms
- Black metal, two piece frame design with thumb screws & Phillips screws provided to securely hold your iPad
- Not intended for frequent iPad removal

Quick Release Adaptor features:

- Convert standard monitor mount into easily removable quick release

Ballast Plate features:

- Adds 2 lb. to monitors that do not meet minimum weight requirements for the Poise and SwingArm

VESA mounts feature:

- 100 mm x 200 mm bracket for larger/heavier monitors for the Poise, SwingArm and Sequoia
- 75 mm x 75 mm recessed for SwingArm only

| Accessory | Compatible with | Model # | Weight |
|-------------------------------|--------------------------|-----------|--------|
| Laptop Holder | Willow, Poise, Sequoia | LTH-1-S | 4 |
| Quick Mount iPad Holder-Black | Willow, Sequoia | IPH-2-B | 1 |
| Quick Mount iPad Holder-Gray | Willow, Sequoia | IPH-2-G | 1 |
| iPad Holder | Willow, Sequoia | IPH-1-B | 2 |
| Quick Release Adaptor | Poise, SwingArm, Sequoia | SAQREL | 1 |
| Ballast Plate | Poise, SwingArm | 4400235 | 2 |
| VESA mount 75 mm x 75 mm | SwingArm | SA-VESA75 | 2 |
| VESA mount 100 mm x 200 mm | Poise | PA-MIS-E | 3 |



The Poise Monitor Arms accept both the Laptop Holder (shown) and iPad holders.



The Quick Mount iPad Holder allows for easy mounting & removal.



The Laptop Holder accommodates most 13"-17" laptops.

Specifications: Laptop Holder

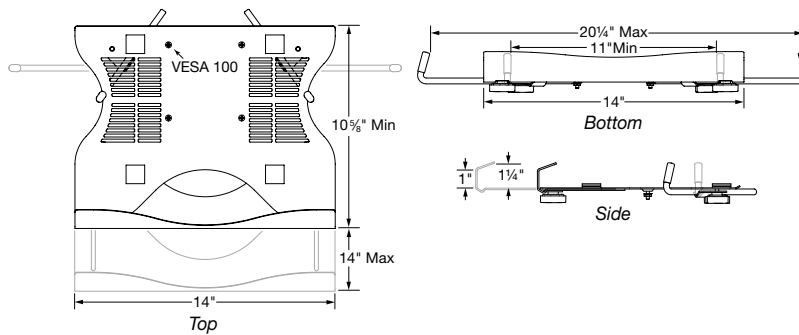

Quick Mount iPad Holder

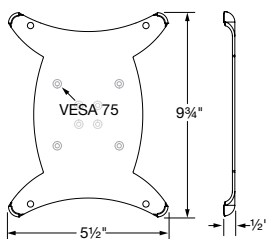

iPad Holder

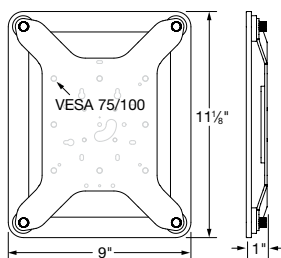

Quick Release Adaptor

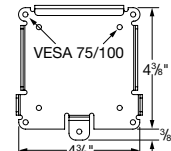

Ballast Plate

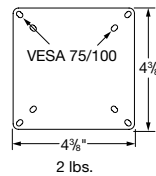

VESA mounts

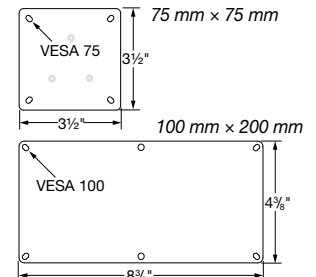

Workrite Ergonomics, Inc. 2277 Pine View Way, Suite 100, Petaluma, CA 94954
www.workriteergo.com 800.959.9675

©2013 Workrite Ergonomics | All referenced company and product names are trademarks, registered trademarks or copyrights of their respective holders.

1400235-0813 Subject to change without notice.

Workrite
ergonomics®