



MAKE THE MOVE TO HEIGHT ADJUSTABILITY

The Workrite Sierra HXL frame set is a great solution for companies who want to add limited sit-stand capabilities to the workplace.

Sierra HXL features a limited height range that adjusts from 25.5"–43" and will accommodate the average male or female worker, whether seated or standing.

The Sierra HXL can handle payloads of 225–300 pounds, is available in 3 contemporary finishes and comes in a wide range of mix and match feature options that can be selected to build the best workcenter for each specific application.



Select the Standard Switch for simple up/down control.



Select the Programmable Switch for a digital readout, preset heights, and much more.

SIERRA HXL™ ELECTRIC FRAME SET

Sierra HXL Electric Frame Set

All Frame Sets include: legs, brackets, motor(s) and cables.

Specifications

- Frame options: 2-leg and 3-leg frames
- 24" or 30" depths
- Widths from 34" to 84" depending on shape
- Finish options: Silver, Charcoal, and White
- Height Range: 25.5" to 43"
- Payload Capacity: 225 pounds for 2-leg models
300 pounds for 3-leg models
- Travel Speed: 1.6 inches per second
- Max Power Draw: 120 V, 60 Hz, 2.9 A (2-leg) 5 A (3-leg)
- Standby Power: 0 .1 W

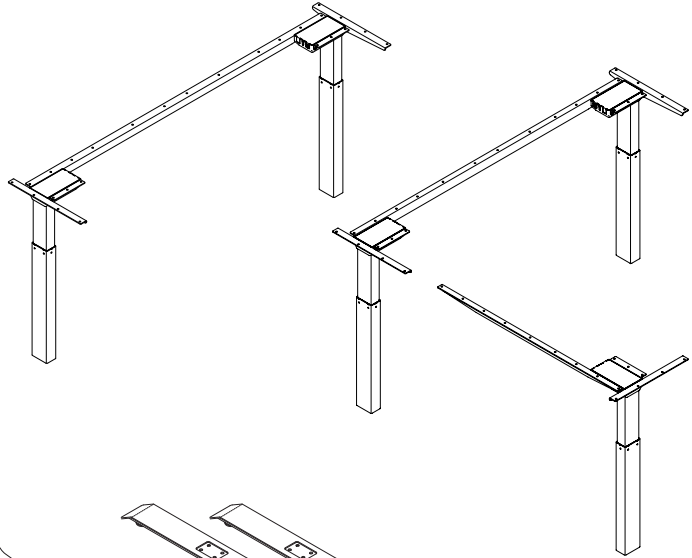

Options sold separately

- Foot Options: 24" or 30" Styled Foot Set
24" or 30" Flat Foot Set
24" & 30" Foot Sets for Dual Depth

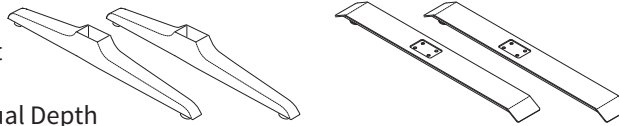

- Control Options: Standard Switch
Programmable Switch

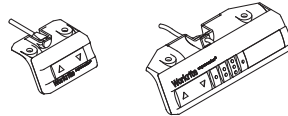

- Laminated Worksurfaces: Any laminate and edge treatment in the Workrite program
- Workrite frame sets can also be used with existing worksurfaces or new worksurfaces from other manufacturers

Dimensions

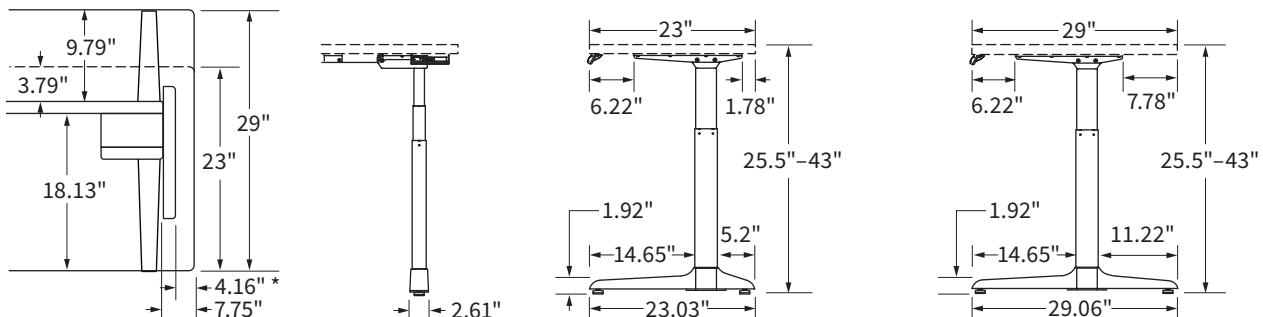

* For Peninsula and P Peninsula worksurfaces, this distance is 14.9"



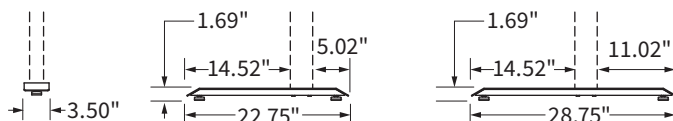





Flat Foot





Products listed on this page are available through GSA Contract GS-28F-0030S SIN #711-2 (Schedule 71)

SIERRA HXL™ ELECTRIC FRAME SET

2-Leg Shapes	Model #		
	Silver	Charcoal	White
	SEHXL36-S	SEHXL36-C	SEHXL36-W
	SEHXL42-S	SEHXL42-C	SEHXL42-W
	SEHXL48-S	SEHXL48-C	SEHXL48-W
	SEHXL54-S	SEHXL54-C	SEHXL54-W
	SEHXL60-S	SEHXL60-C	SEHXL60-W
	SEHXL66-S	SEHXL66-C	SEHXL66-W
	SEHXL72-S	SEHXL72-C	SEHXL72-W
			
			

Equal Corners	Model #
	SEHXL54EC-S
	SEHXL60EC-S
	SEHXL66EC-S
	SEHXL72EC-S
	SEHXL54EC-C
	SEHXL60EC-C
	SEHXL66EC-C
	SEHXL72EC-C
	SEHXL54EC-W
	SEHXL60EC-W
	SEHXL66EC-W
	SEHXL72EC-W

Offset Corners	Model #
	SEHXL5442OC-S
	SEHXL6048OC-S
	SEHXL6642OC-S
	SEHXL6654OC-S
	SEHXL7248OC-S
	SEHXL7260OC-S
	SEHXL7842OC-S
	SEHXL8448OC-S
	SEHXL5442OC-C
	SEHXL6048OC-C
	SEHXL6642OC-C
	SEHXL6654OC-C
	SEHXL7248OC-C
	SEHXL7260OC-C
	SEHXL7842OC-C
	SEHXL8448OC-C
	SEHXL5442OC-W
	SEHXL6048OC-W
	SEHXL6642OC-W
	SEHXL6654OC-W
	SEHXL7248OC-W
	SEHXL7260OC-W
	SEHXL7842OC-W
	SEHXL8448OC-W

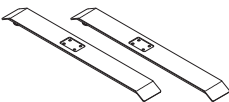
Workcenter Feet	Worksurface Depth	Model #
Flat Foot Set 	24"	FFK24-S
	30"	FFK30-S
	Dual Depth	FFK2430-S
		FFK24-C
		FFK30-C
		FFK2430-C
		FFK24-W
		FFK30-W
		FFK2430-W

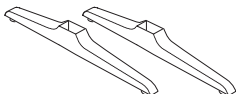
Styled Foot Set 	24"	SFK24-S
	30"	SFK30-S
	Dual Depth	SFK2430-S
		SFK24-C
		SFK30-C
		SFK2430-C
		SFK24-W
		SFK30-W
		SFK2430-W

Workcenter Controls	Model #
Standard Switch 	STDSWITCH

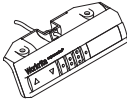
Programmable Switch 	PROSWITCH
---	-----------

Workcenter Accessories	Height	Model#
Bench Mount Kit	1.12"–1.5"	BMK-1-B

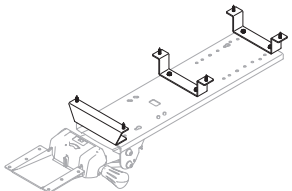

Designed for mounting keyboard arms to Sierra HXL Electric Workcenters where linear supports limit the availability of a flat mounting surface. Attaches between the underside of the worksurface and the keyboard arm track. Used for all installations of tracks greater than 17".

- Fits all Workrite keyboard arms
- Powered coated steel construction

WORKSURFACES



HOW TO CONFIGURE YOUR WORKSURFACE

Select a worksurface laminate & edgeband

Workrite's standard laminated worksurface program features 19 popular Wilsonart® laminates with coordinating 3 mm edgeband options. For larger, more accurate swatches of available laminates, please refer to the Materials & Finishes tab of the Workrite binder.

Laminates



Edgeband



A guide to the edge treatment model

Edge treatment part numbers consist of :

Worksurface size Edge type
T3423-B3

The example given is for a 34" wide, 23" deep rectangle that fits a 36" x 24" space, with 3 mm block edge

A guide to the laminate model

Laminate part numbers consist of :

Laminate color Edgeband color
0705460-152

The example shown is for a top in Wild Cherry with Rainier Cherry 3 mm edgeband.



3mm Edge Band

Special order worksurfaces

Additional Wilsonart laminates and edge treatments may be available through our Special Order Program. Special order laminates and edge treatments are subject to minimum order quantities and require extended lead times. See the Special Order information in the Materials & Finishes tab of the Workrite binder.