

# STYLEVIEW® QUICK REFERENCE

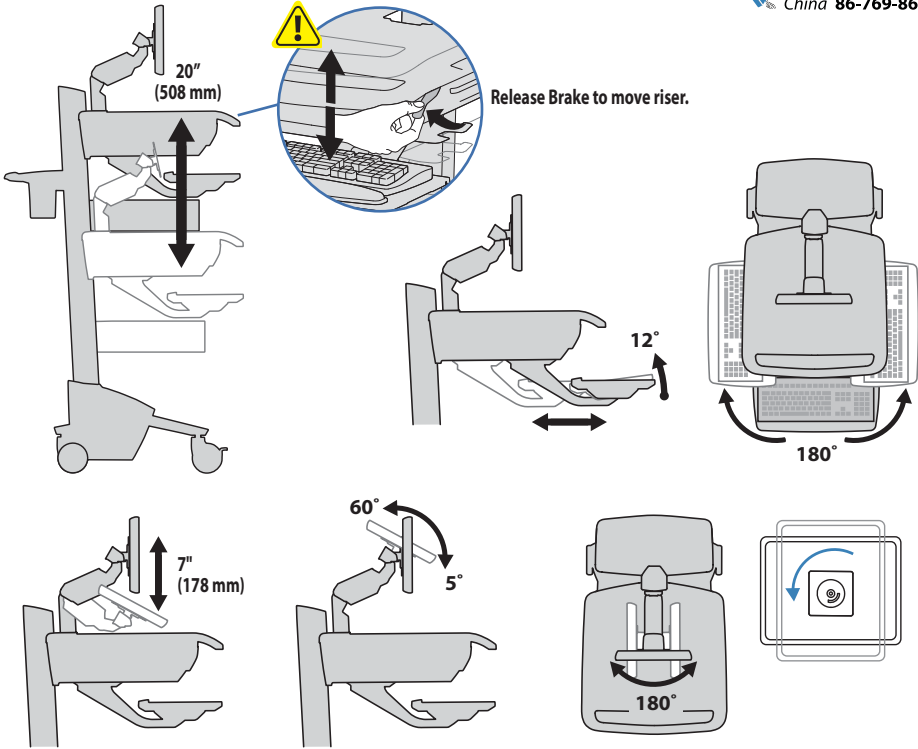

## RANGE OF MOTION



## ERGONOMICS

### Working - customize - to your size

- 1 Set top of monitor screen about one inch below eye level - Release brake and lift or lower riser as needed.
- 2 Tilt screen for comfortable viewing and to reduce eye and neck strain.
- 3 Pull keyboard tray forward and position mouse tray and mouse pouch on right or left, as needed.
- 4 Work with elbows bent at about 90° to minimize muscle strain.
- 5 If the riser moves up and down with difficulty, or if it drifts out of set position, consult the product manual for adjustment information.
- 6 Stay in charge!  
Powered carts should be plugged into outlet as often as possible to keep battery charged and computer running.

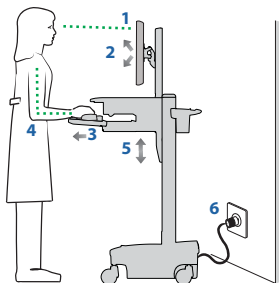

### Moving - stop - before you go

- 1 During normal movement, release brake and lower worksurface to lowest position for optimal stability and unobstructed view.
- 2 Tuck away open trays and return mouse, scanner and other accessories to their places.
- 3 Unlock both front casters.
- 4 Push cart from rear with elbows bent at about 90° to maximize control and minimize muscle strain.
- 5 Don't run out!  
Before moving, make sure cord is unplugged from outlet and hooked to basket for safe travel. Remember, charge battery fully 100% every day!

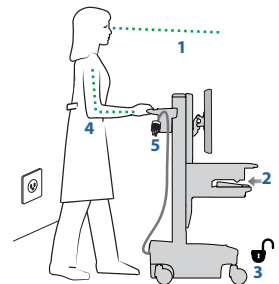

# STYLEVIEW® QUICK REFERENCE



## KEYBOARD LIGHT

Your computer must be on for this light to function.

Keyboard Light will automatically turn off after 15 minutes if not manually turned off.

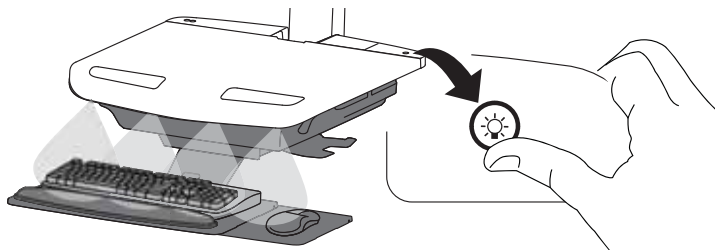

### Unlock Drawer (3 methods):

- Enter Master PIN, then press desired drawer number\*.
- Enter User PIN, then press desired drawer number\*.
- Key - turn clockwise 1/4 turn

\*Drawer Numbers:

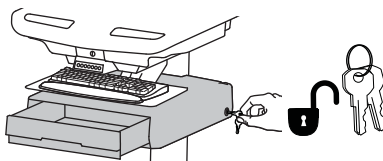
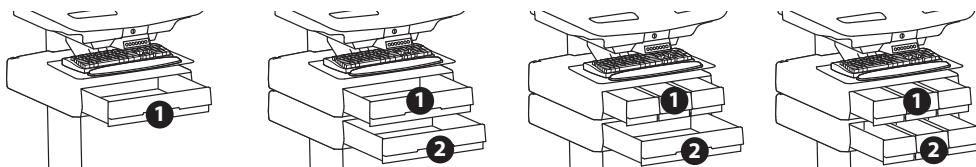

### Lock Drawer:

- Wait 4 seconds for lock to engage automatically.

NOTE: Drawer must be fully closed to lock.

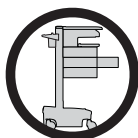

**CAUTION:** Close worksurface before opening drawers. Open only one drawer at a time. Do Not push cart when drawers or worksurface are open. Failure to follow these instructions may cause the cart to be unstable.