



Connect with Chief's Fusion™ flat panel mounts. Video conference with any associate without the time or expenses of travel. Meet with international or out-of-state offices in the comfort of your own office or boardroom. Fusion mounts easily join together to create customized video conferencing configurations perfect for any installation; streamline video conferences via projector, or mobilize your setup with a Chief cart or stand.

www.chiefmfg.com

FUSION SERIES MOUNTS

TAKE CONTROL OF YOUR INSTALL

- 1** **CENTERLESS™ LATERAL SHIFT**
Get up to 16" of post-installation lateral shift - 8" left/right of uprights.
- 2** **CONTROLZONE™ HEIGHT & ROLL ADJUSTMENT**
Fine-tune height and leveling after the mount is installed by inserting an Allen key into the ports located at the top of the uprights.
- 3** **CENTRIS™ LOW-PROFILE TILT**
Provides effortless tilting by using the center of gravity to balance the screen – no tools necessary!
- 4** **CLICKCONNECT™ TOOL-LESS LATCHING**
Hear an audible click when the screen safely engages with the mount. Use the built-in cable stand to gain easy access under the screen.

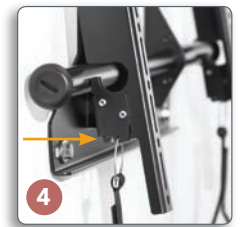
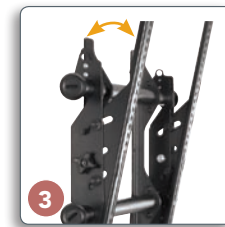
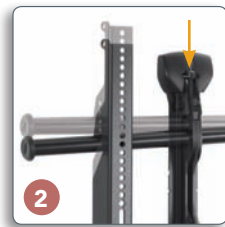
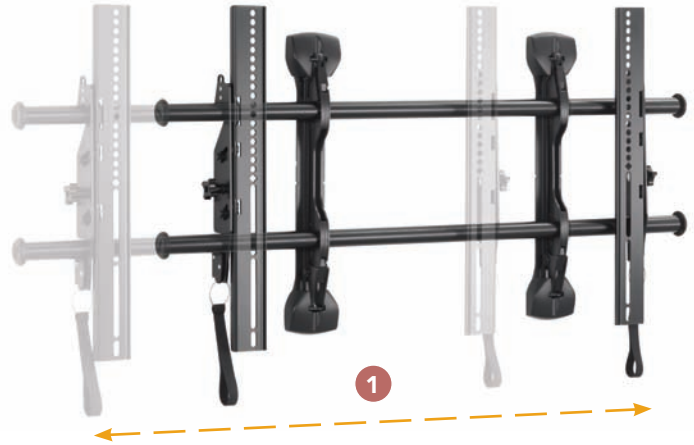

ACCESSORIES

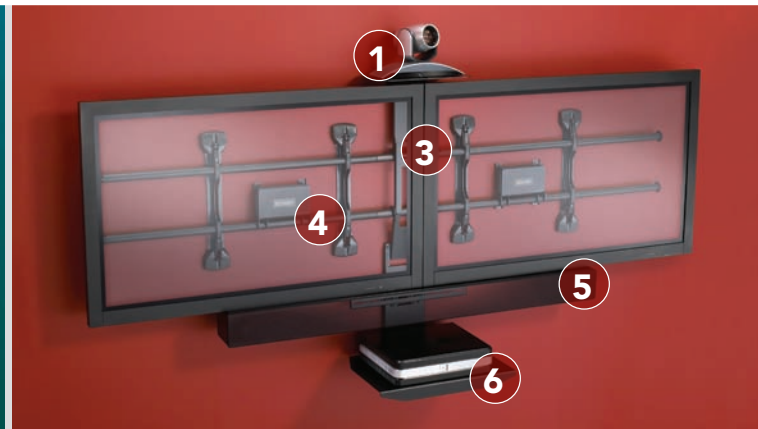
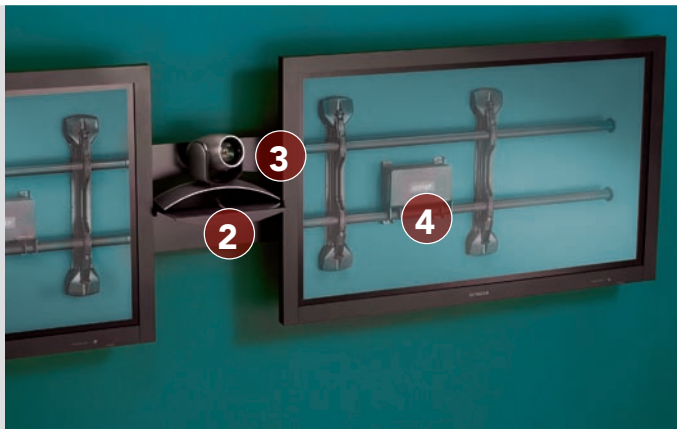

FVS100™ / FVS150™
8" and 12" VC
Shelves - below



3 **FCK008™ & FCK016™***
8" and 16" Connector Kit



FCS100™
Single Component
Shelf - below



1 **FVS200™ / FVS250™**
8" and 12" VC
Shelves - above



4 **FCA100™**
Cat 5/Surge
Adapter



6 **FCD100™****
Additional Component
Shelf - below



2 **FVS300™ / FVS350™**
8" and 12" VC Shelves
- between two screens



5 **FCC100™**
Center Channel
Speaker Adapter



PAC521P™
In-Wall Power Box

* FCK008 recommended when installing 37-42" screens on L-series of Fusion. All others can use the FCK016. FCK008/FCK016 required when using FVS300/FVS350 shelves.
** Can be used with FCS100, FCC100 or FVS100/150 shelves.

SPECIFICATION KEY

TV: TV Screen Size D: Depth from Wall C: Color
 W: Weight Capacity E: Extension T: Tilt

PREFERRED SOLUTIONS

For more information on Chief products, visit us on the web at www.chiefmfg.com.

MEDIUM

FUSION FIXED MOUNTS

MSMU™ with ControlZone™ Leveling

TV: 26 - 47"
 W: 125 lbs (56.7 kg)
 D: 1.96" (50 mm)
 C: ■

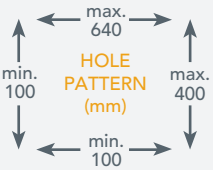

max. 640
min. 100
max. 400
min. 100
HOLE PATTERN (mm)



Also Available: **MTMU™**
Up to 667 x 400 mm

MEDIUM

SWING ARM MOUNTS

MWRU™

TV: 30 - 55"
 W: 125 lbs (56.7 kg)
 E: 24.88" (632 mm)
 C: ■ ■

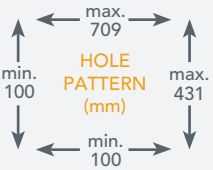

max. 709
min. 100
max. 431
min. 100
HOLE PATTERN (mm)



Also Available: **PWRU™**

ACCESSORIES

PAC150™
Video Conferencing Shelf



LARGE

LSMU™ with ControlZone™ Leveling

TV: 37 - 63"
 W: 200 lbs (90.7 kg)
 D: 1.96" (50 mm)
 C: ■

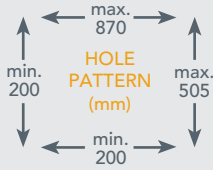

max. 870
min. 200
max. 505
min. 200
HOLE PATTERN (mm)



Also Available: **LTMU™**
Up to 895 x 506 mm

LARGE

PNRU™

TV: 42 - 71"
 W: 200 lbs (90.7 kg)
 E: 24.88" (632 mm)
 C: ■ ■

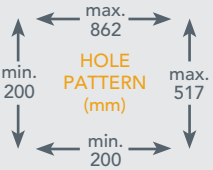

max. 862
min. 200
max. 517
min. 200
HOLE PATTERN (mm)



PACCC1™
Center Channel Speaker Adapter



LARGE

*LSAU™

TV: 37 - 63"
 W: 200 lbs (90.7 kg)
 D: 1.96" (50 mm)
 C: ■

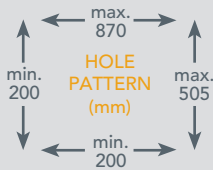

max. 870
min. 200
max. 505
min. 200
HOLE PATTERN (mm)



Also Available: ***LTAU™**
Up to 895 x 506 mm

IN-WALL

MIWRF™

TV: 30 - 55"
 W: 125 lbs (56.7 kg)
 E: 9.9" (251 mm)
 C: ■

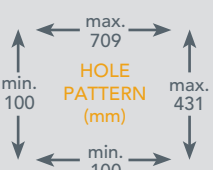

max. 709
min. 100
max. 431
min. 100
HOLE PATTERN (mm)



PACLR1™
Left/Right Speaker Adapter



EXTRA LARGE

XSMU™ with ControlZone™ Leveling

Shipping May 2009

TV: 55 - 75"
 W: 250 lbs (113 kg)
 D: 1.96" (50 mm)
 C: ■

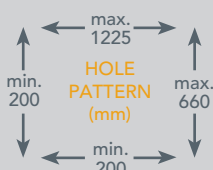

max. 1225
min. 200
max. 660
min. 200
HOLE PATTERN (mm)

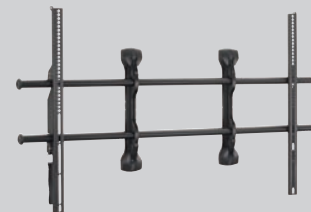

Also Available: **XTMU™**
Up to 1249 x 685 mm

IN-WALL

PIWRF™

TV: 42 - 65"
 W: 200 lbs (90.7 kg)
 E: 15" (381 mm)
 C: ■

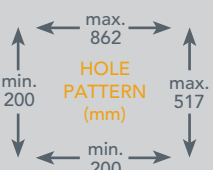

max. 862
min. 200
max. 517
min. 200
HOLE PATTERN (mm)



PAC251™
P-Series Media Adapter



MAC251™
M-Series Media Adapter



* LSAU is *not* equipped with ControlZone. MSAU, MTAU and LTAU Fusion fixed and tilt mounts (without ControlZone) also available. Chief recommends Fusion products with ControlZone.

ELITE PROJECTOR MOUNTS

RPA Elite™ Projector Mount *Universal Option Shown*

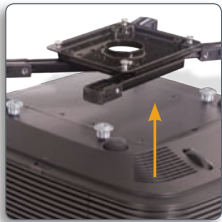

**DUAL-DISCONNECT
EASY FILTER ACCESS**
Dual disconnect system for fast installation and lamp/filter access.



**Q-LOCK™ INTEGRATED
LOCKING LEVER**
Provides enhanced security with an integrated key and lock system.
Optional – must order RPMA/B/C with A, B or C to designate key option.



**MICROZONE™
MICRO-ADJUSTMENT**
For fast and precise projector registration, including flush-mount installations.



**CENTRIS™ TECHNOLOGY
FINGERTIP ADJUSTMENT**
Enables effortless, fingertip positioning.

ORDERING OPTIONS

Model	Type	Max Weight	Color(s)
RPM*	Custom	50 lbs (22.7 kg)	■
RPM-U*	Universal	50 lbs (22.7 kg)	■ ■ ■
RPA	Custom	50 lbs (22.7 kg)	■
RPA-U	Universal	50 lbs (22.7 kg)	■ ■ ■

*For Q-Lock™ integrated security, order RPMA, RPMB or RPMC with A, B or C designating the key option.

ACCESSORIES

Model	Description	Color(s)
CMS™-0XX	1-1/2" NPT Fixed Extension Column	■ ■ ■
CMS™-0XX0XX	1-1/2" NPT Adjustable Extension Column	■ ■ ■
CMS115™	Ceiling Plate	■ ■ ■
CMS440™	Lightweight Suspended Ceiling Kit	■
CMS445™	Ceiling Tile Replacement Kit	■
CMA470™	Plenum Enclosure	■



CMS-0XX0XX



CMS440



CMA470



CMS445



CMS115



Chief Manufacturing ■ A Division of Milestone AV Technologies ■ 800.582.6480 USA ■ 877.345.4329 Canada ■ www.chiefmfg.com

©2009 Milestone AV Technologies, a Duchossois Group Company. 900016A 3/09. Chief is a registered trademark of Milestone. All other brand names or marks are used for identification purposes and are trademarks of their respective owners. All patents are protected under existing designations. Other patents pending. Printed in the USA.