

BALT[®]

Presentation Cart

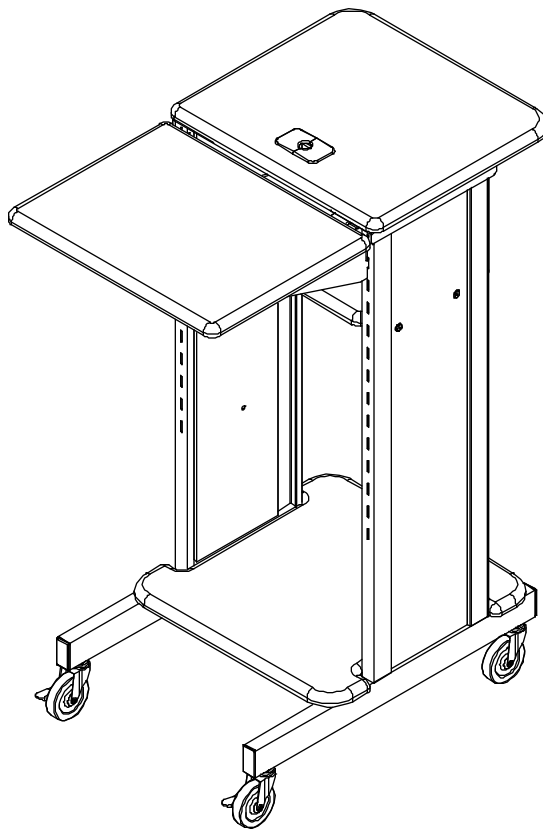









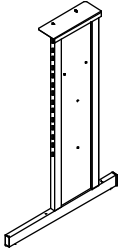
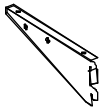
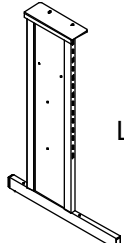
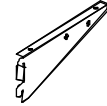
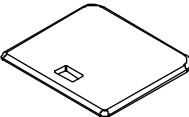
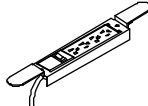
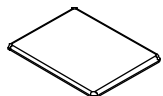
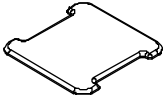





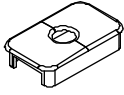

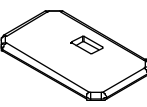
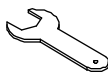
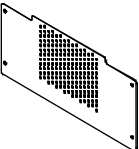
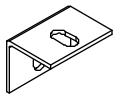



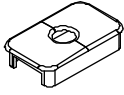

AV Cart w/Adjustable Height Shelf

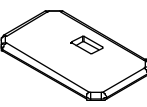
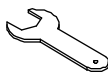
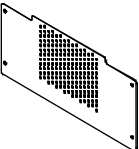
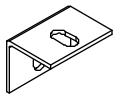

Assembly Instructions

Presentation Cart

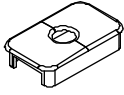
AV Cart w/Adjustable Height Shelf

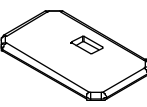
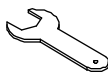
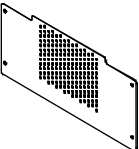
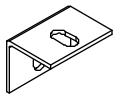
Part	Drawing	Description	Qty	Part	Drawing	Description	Qty																																																
P1		Leg Assembly Right	1 EA	P-9		Right Shelf Bracket	1 EA																																																
P2		Leg Assembly Left	1 EA	P-10		Left Shelf Bracket	1 EA																																																
P3		LCD Platform	1 EA	 Optional Electrical Outlet W/Cord Winder 1 EA																																																			
P4		Laptop Shelf	1 EA																																																				
P5		Lower Shelf	1 EA	<h3 style="text-align: center;">Hardware List</h3> <table border="0"> <tr> <td>A</td> <td></td> <td>9/16" Socket Screw</td> <td>20 EA</td> </tr> <tr> <td>B</td> <td></td> <td>2-1/2" Socket Screw</td> <td>4 EA</td> </tr> <tr> <td>C</td> <td></td> <td>Square Nut</td> <td>4 EA</td> </tr> <tr> <td>D</td> <td></td> <td>3" Locking Caster</td> <td>2 EA</td> </tr> <tr> <td>E</td> <td></td> <td>3" Caster</td> <td>2 EA</td> </tr> <tr> <td>E</td> <td></td> <td>Plastic Grommet</td> <td>2 EA</td> </tr> <tr> <td>F</td> <td></td> <td>Allen Wrench</td> <td>1 EA</td> </tr> <tr> <td>P6</td> <td></td> <td>Middle Shelf</td> <td>1 EA</td> <td>G</td> <td></td> <td>Caster Wrench</td> <td>1 EA</td> </tr> <tr> <td>P7</td> <td></td> <td>Stability Panel</td> <td>1 EA</td> <td colspan="4"> <p style="text-align: center;"><i>We recommend that you assemble this unit on a table.</i></p> <p>Tools required: Adjustable Crescent Wrench</p> </td> </tr> <tr> <td>P8</td> <td></td> <td>Angle Bracket</td> <td>4 EA</td> </tr> </table>				A		9/16" Socket Screw	20 EA	B		2-1/2" Socket Screw	4 EA	C		Square Nut	4 EA	D		3" Locking Caster	2 EA	E		3" Caster	2 EA	E		Plastic Grommet	2 EA	F		Allen Wrench	1 EA	P6		Middle Shelf	1 EA	G		Caster Wrench	1 EA	P7		Stability Panel	1 EA	<p style="text-align: center;"><i>We recommend that you assemble this unit on a table.</i></p> <p>Tools required: Adjustable Crescent Wrench</p>				P8		Angle Bracket	4 EA
A		9/16" Socket Screw	20 EA																																																				
B		2-1/2" Socket Screw	4 EA																																																				
C		Square Nut	4 EA																																																				
D		3" Locking Caster	2 EA																																																				
E		3" Caster	2 EA																																																				
E		Plastic Grommet	2 EA																																																				
F		Allen Wrench	1 EA																																																				
P6		Middle Shelf	1 EA	G		Caster Wrench	1 EA																																																
P7		Stability Panel	1 EA	<p style="text-align: center;"><i>We recommend that you assemble this unit on a table.</i></p> <p>Tools required: Adjustable Crescent Wrench</p>																																																			
P8		Angle Bracket	4 EA																																																				

Missing Parts or UPS Damaged Parts
 For Your Convenience you can
 EMAIL us at
furniture@baltinc.com
 24HOURS 7 DAYS A WEEK

Do not use unless all screws are tight. At least every six months, check all screws to be sure they are tight. If parts are missing, broken, damaged, or worn, stop use of the product until repairs are made by your dealer using factory authorized parts.

Presentation Cart Assembly Diagram



READ THROUGH INSTRUCTIONS FROM BEGINNING TO END BEFORE STARTING TO ASSEMBLE UNIT.

- 1.) Identify and Separate all the Parts and Hardware.
- 2.) Place the LCD Platform (P-3) with the insert nuts facing up. Attach 1 Right Leg Assembly (P-1) and 1 Left Leg Assembly (P-2) using 4 each (A) screws.
(Finger tighten only)

Should you require assistance during assembly, please call our Customer Service Department Monday - Friday 8 a.m. - 5 p.m. Central Standard Time 1-800-749-2258

- 3.) Attach Stability Panel (P-7) to Right & Left Leg Assemblies (P-1 & P-2) using 4 (A) Screws as shown in illustration #1.
(Finger tighten only)

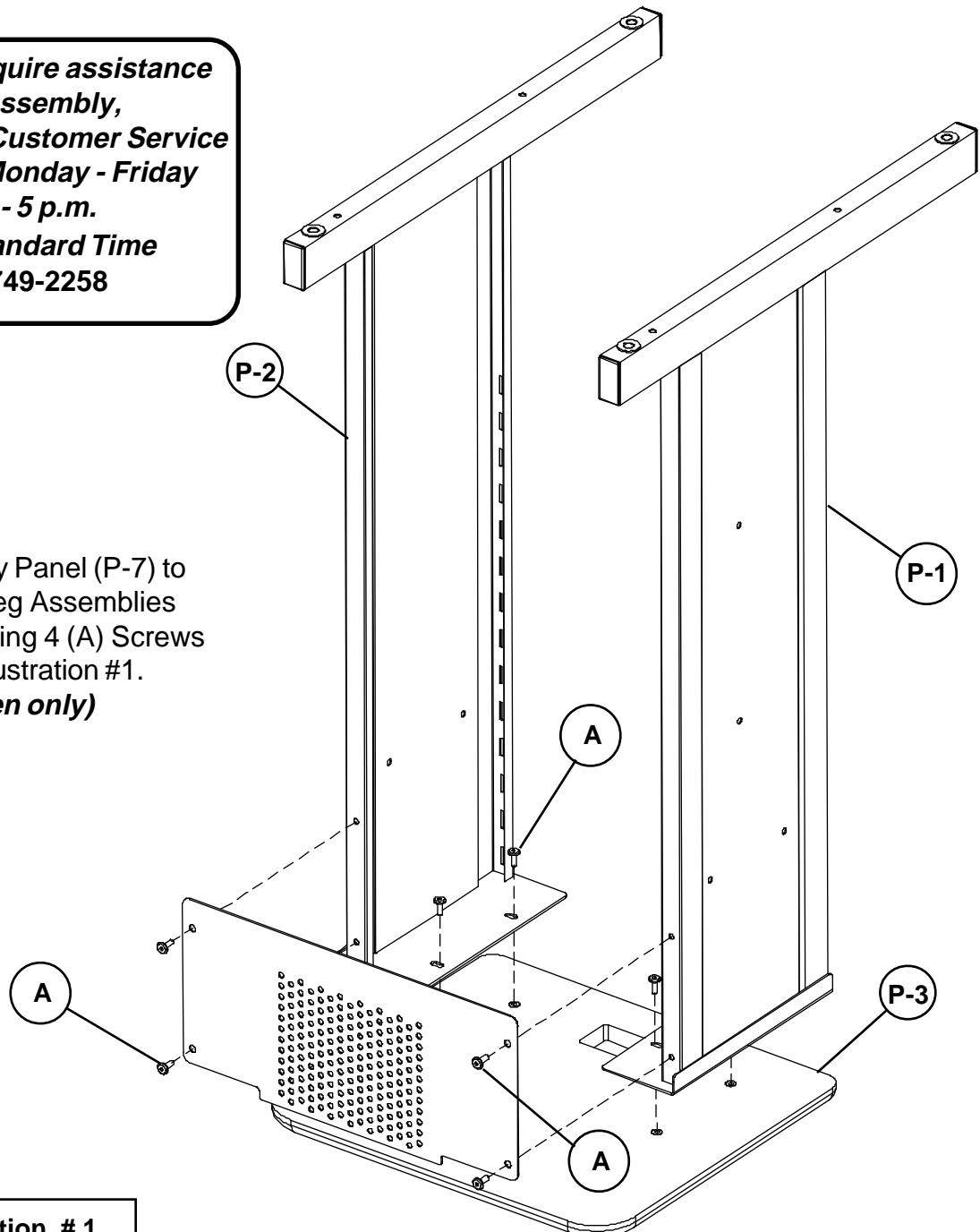
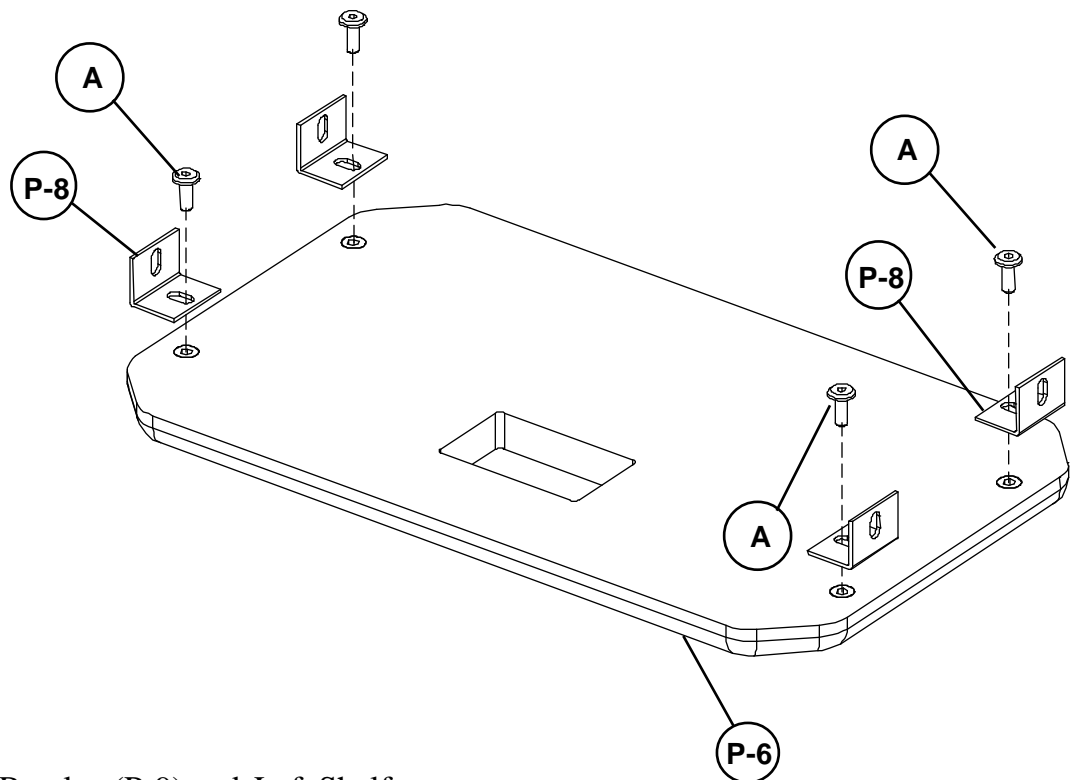

Illustration # 1

4.) Align 4 each Angle Brackets (P-8) with the edge of the Middle Shelf (P-6) and attach using 4 each (A) Screws as shown in illustration #2. (**Finger tighten only**)

Illustration # 2



5.) Attach Right Shelf Bracket (P-9) and Left Shelf Bracket (P-10) to Laptop Shelf (P-4) using 4 Flat Head screws (A) as shown in illustration # 4.

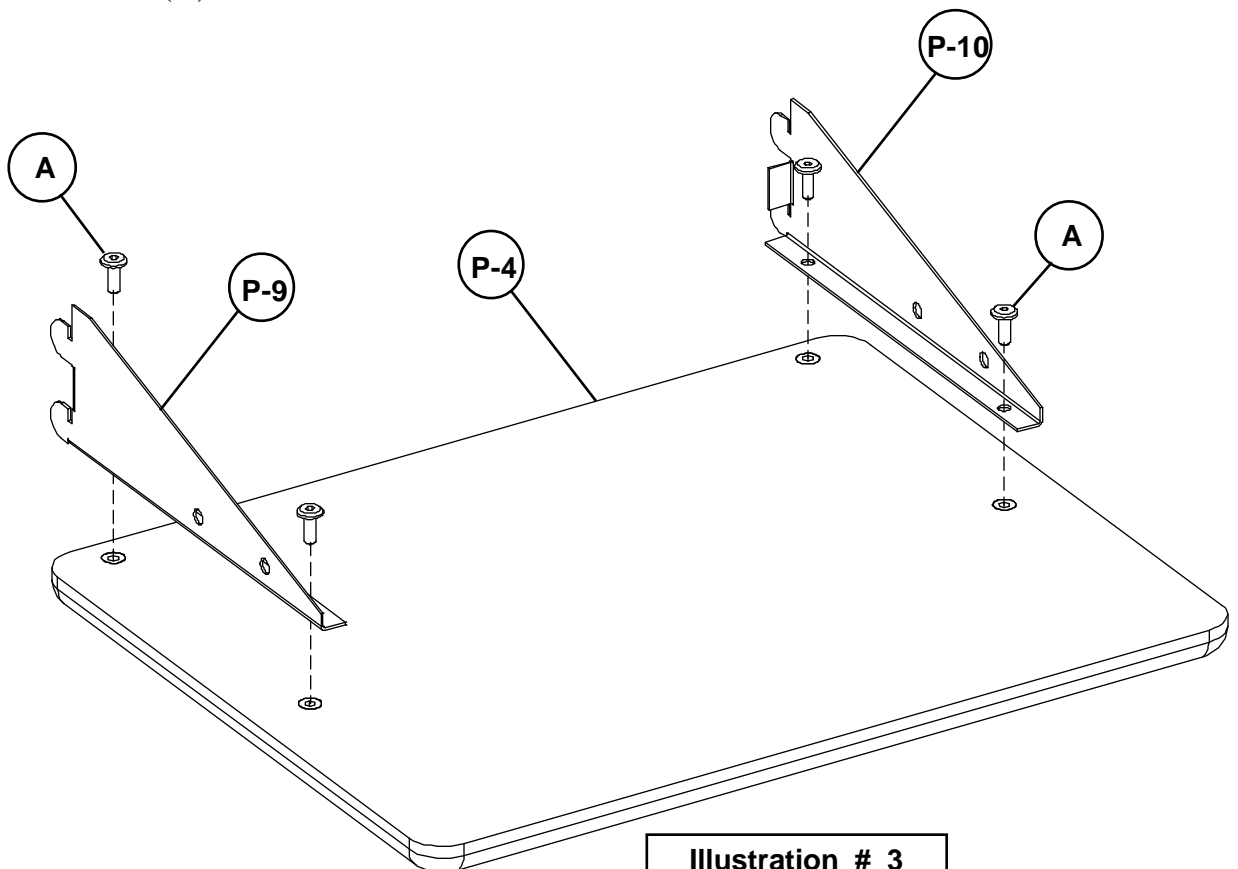
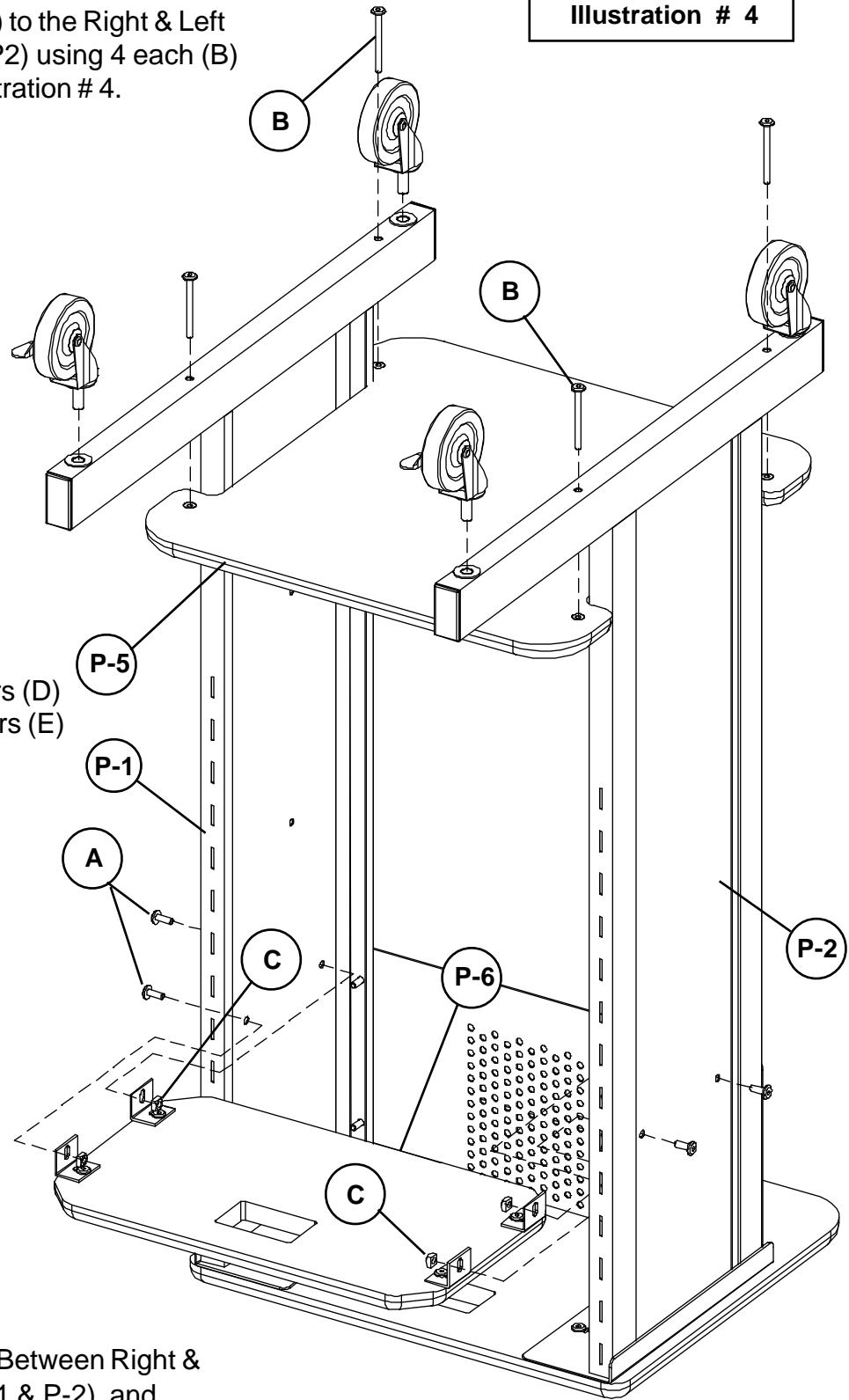

Illustration # 3

Illustration # 4

- 6.) Attach Lower Shelf (P-5) to the Right & Left Leg Assemblies (P1 & P2) using 4 each (B) screws as shown in illustration # 4.
(Finger tighten only)



- 7.) Attach 2 Locking Casters (D) to the front, and 2 Casters (E) to the back of the unit. Tighten all Casters using Caster Wrench (G).

- 8.) Slide Middle Shelf (P-6) Between Right & Left Leg Assemblies (P-1 & P-2) and attach Middle Shelf (P-5) using 4 each (A) screws and 4 each (C) Square Nuts as shown in illustration # 4.

- 9.) *(Tighten all the screws at this time using Allen Wrench (F)).*

10.) To install Grommets (E) in LCD Platform (P-3) and Middle Shelf (P-6), separate parts and press Grommet Sleeve in rectangular openings as shown in illustration # 5.

11.) Snap 2 plastic Caps over top of Sleeve as shown in illustration # 5.

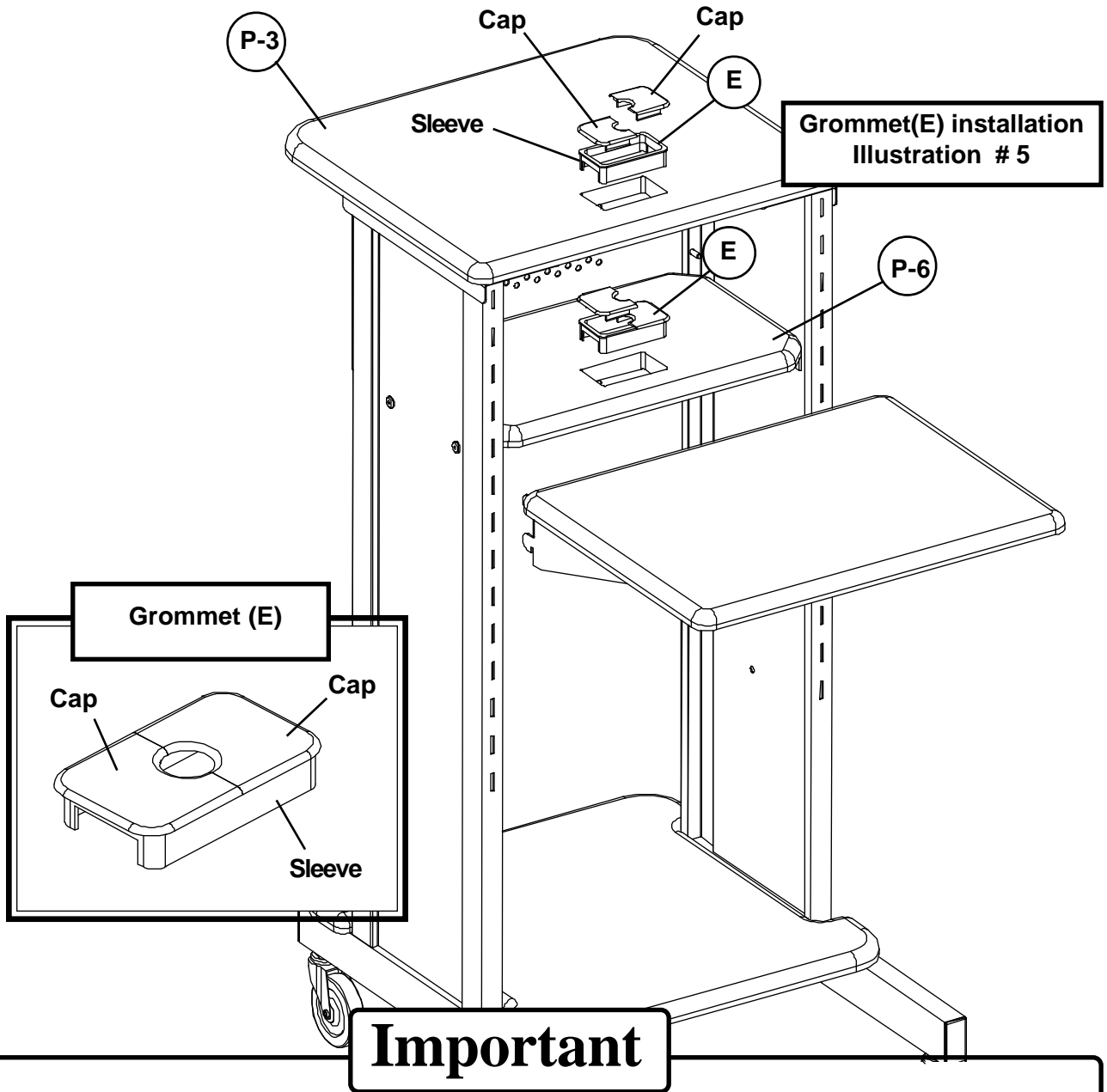



The Balt product you have purchased is guaranteed against material and workmanship defects. This guarantee extends 1 year from date of purchase. Should this product fail to function satisfactorily under normal use due to defect or imperfection, the defective part or product will be replaced. Damage caused by common carriers during shipment is not included in this guarantee.

This guarantee sets forth all applicable guarantees and remedies. No other warranty, expressed or implied shall apply. Failure to follow instructions found in Important Information Section of Owner Sheet shall void the guarantee. Consequential or incidental damages and or costs are not refundable.

Optional Electric Outlet Assembly Diagram

***This Electrical Outlet is Part # 66450 and must be purchased separately
Please contact our Customer Service Department
Monday - Friday
8 a.m. - 5 p.m.
Central Standard Time
1-800-749-2258***

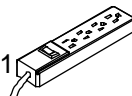
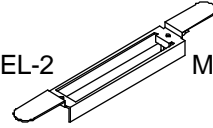
Parts/Hardware List

EL-1		Electric Outlet	1 EA
EL-2		Metal Bracket w/Cord Winder	1 EA
EL-3		Phillips Head Screw	2 EA
EL-4		Hex Nut	2 EA

- 1.) Identify and Separate all the Parts and Hardware.
- 2.) Slide Metal Bracket (EL-2) over the Electrical Outlet (EL-1) as shown. (note that Metal Stop is at the end with the electrical Plug-in.)
- 3.) Attach Metal Bracket (EL-2) to the Right or Left Leg Assembly (P-1 or P-2) using 2 Phillips Head Screws (EL-3) and 2 Hex Nuts (EL-4) as shown in Optional Electrical illustration.

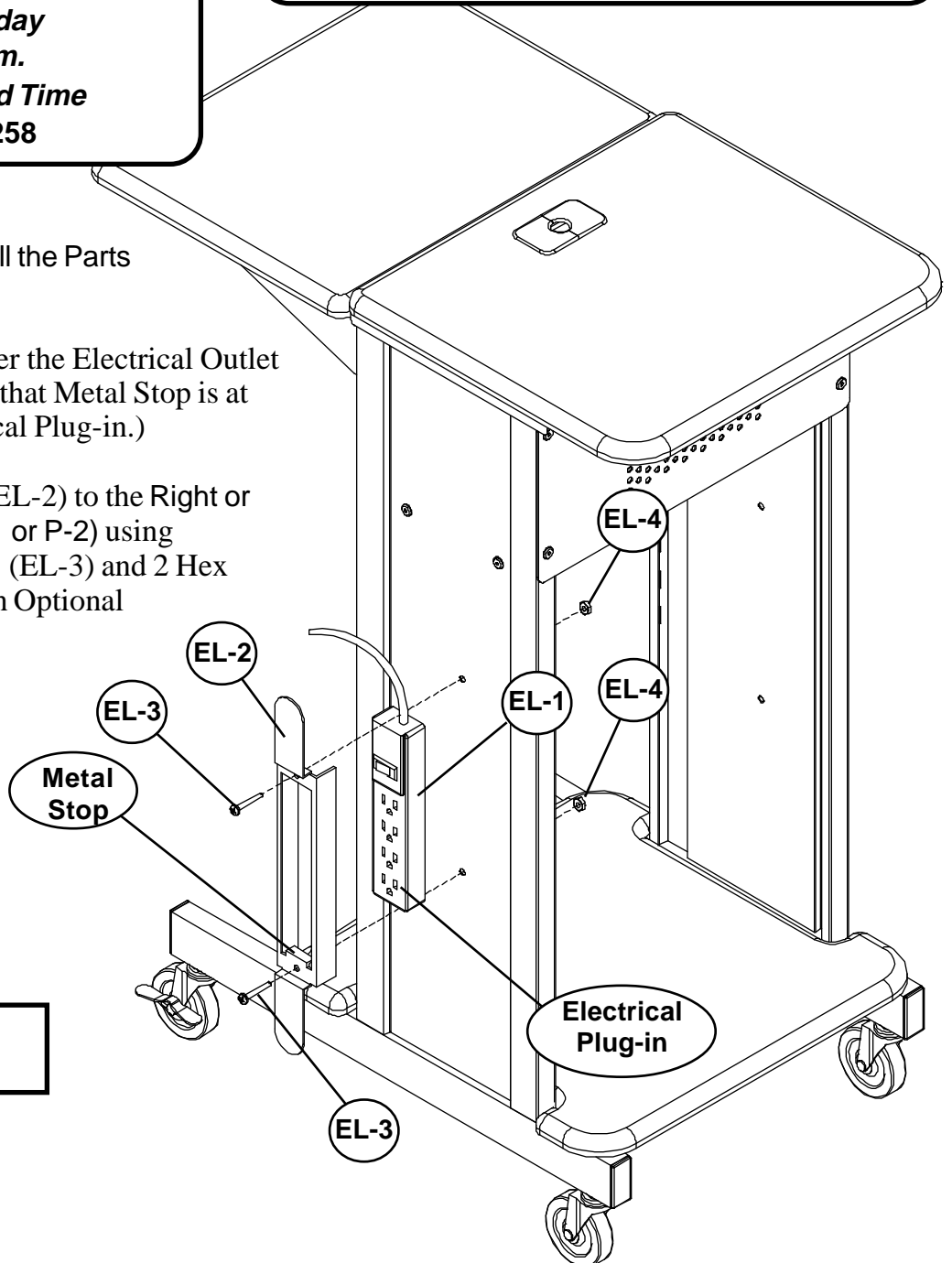

**Optional Electrical
Illustration**