

**BALT**<sup>®</sup>

# Presentation Cart

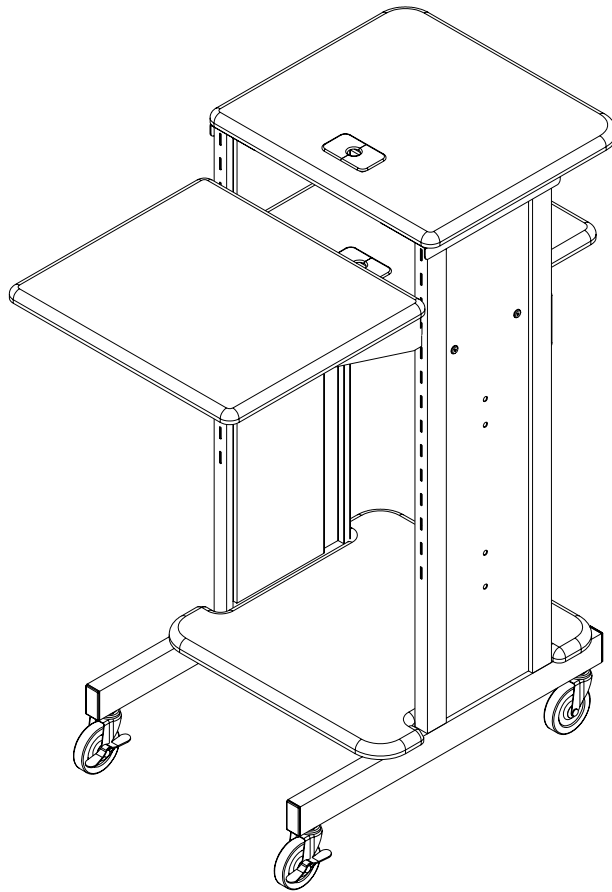









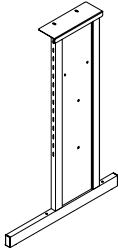
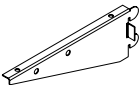
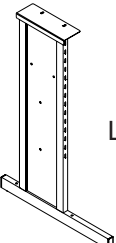
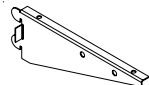
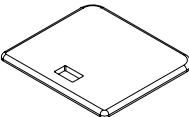
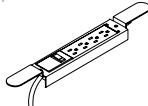
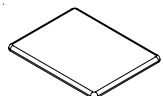
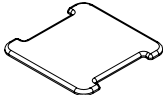

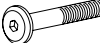



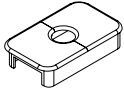

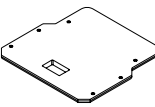

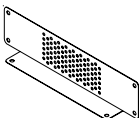
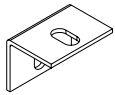

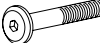



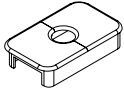

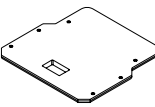

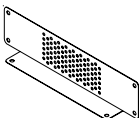
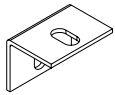
AV Cart w/ Adjustable Height Shelf

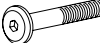

## Assembly Instructions

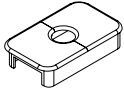
# Presentation Cart

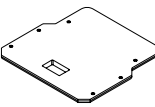
## AV Cart w/Adjustable Height Shelf

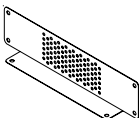
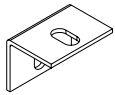
Part	Drawing	Description	Qty	Part	Drawing	Description	Qty																																																
P1		Leg Assembly Right	1 EA	P-9		Right Shelf Bracket	1 EA																																																
P2		Leg Assembly Left	1 EA	P-10		Left Shelf Bracket	1 EA																																																
P3		LCD Platform	1 EA	 Optional Electrical Outlet W/Cord Winder 1 EA																																																			
P4		Laptop Shelf	1 EA																																																				
P5		Lower Shelf	1 EA	<h3 style="text-align: center;">Hardware List</h3> <table border="0"> <tr> <td>A</td> <td></td> <td>9/16" Socket Screw</td> <td>22 EA</td> </tr> <tr> <td>B</td> <td></td> <td>2-1/2" Socket Screw</td> <td>4 EA</td> </tr> <tr> <td>C</td> <td></td> <td>Square Nut</td> <td>4 EA</td> </tr> <tr> <td>D</td> <td></td> <td>3" Locking Caster</td> <td>2 EA</td> </tr> <tr> <td>E</td> <td></td> <td>3" Caster</td> <td>2 EA</td> </tr> <tr> <td>E</td> <td></td> <td>Plastic Grommet</td> <td>2 EA</td> </tr> <tr> <td>F</td> <td></td> <td>Allen Wrench</td> <td>1 EA</td> </tr> <tr> <td>P6</td> <td></td> <td>Middle Shelf</td> <td>1 EA</td> <td>G</td> <td></td> <td>Caster Wrench</td> <td>1 EA</td> </tr> <tr> <td>P7</td> <td></td> <td>Stability Panel</td> <td>1 EA</td> <td colspan="4"> <p style="text-align: center;"><i>We recommend that you assemble this unit on a table.</i></p> <p>Tools required: Adjustable Crescent Wrench</p> </td> </tr> <tr> <td>P8</td> <td></td> <td>Angle Bracket</td> <td>4 EA</td> </tr> </table>				A		9/16" Socket Screw	22 EA	B		2-1/2" Socket Screw	4 EA	C		Square Nut	4 EA	D		3" Locking Caster	2 EA	E		3" Caster	2 EA	E		Plastic Grommet	2 EA	F		Allen Wrench	1 EA	P6		Middle Shelf	1 EA	G		Caster Wrench	1 EA	P7		Stability Panel	1 EA	<p style="text-align: center;"><i>We recommend that you assemble this unit on a table.</i></p> <p>Tools required: Adjustable Crescent Wrench</p>				P8		Angle Bracket	4 EA
A		9/16" Socket Screw	22 EA																																																				
B		2-1/2" Socket Screw	4 EA																																																				
C		Square Nut	4 EA																																																				
D		3" Locking Caster	2 EA																																																				
E		3" Caster	2 EA																																																				
E		Plastic Grommet	2 EA																																																				
F		Allen Wrench	1 EA																																																				
P6		Middle Shelf	1 EA	G		Caster Wrench	1 EA																																																
P7		Stability Panel	1 EA	<p style="text-align: center;"><i>We recommend that you assemble this unit on a table.</i></p> <p>Tools required: Adjustable Crescent Wrench</p>																																																			
P8		Angle Bracket	4 EA																																																				

**Missing Parts or UPS Damaged Parts**  
 For Your Convenience you can  
 EMAIL us at  
**furniture@baltinc.com**  
 24HOURS 7 DAYS A WEEK

Do not use unless all screws are tight. At least every six months, check all screws to be sure they are tight. If parts are missing, broken, damaged, or worn, stop use of the product until repairs are made by your dealer using factory authorized parts.

# Presentation Cart Assembly Diagram



**READ THROUGH INSTRUCTIONS FROM BEGINNING TO END BEFORE STARTING TO ASSEMBLE UNIT.**

- 1.) Identify and Separate all the Parts and Hardware.
- 2.) Place the LCD Platform (P-3) with the insert nuts facing up. Attach 1 Right Leg Assembly (P-1) and 1 Left Leg Assembly (P-2) using 4 each (A) screws.  
*(Finger tighten only)*

**Should you require assistance during assembly, please call our Customer Service Department Monday - Friday 8 a.m. - 5 p.m. Central Standard Time 1-800-749-2258**

- 3.) Attach Stability Panel (P-7) to Right & Left Leg Assemblies (P-1 & P-2) using 4 (A) Screws as shown in illustration #1.  
*(Finger tighten only)*

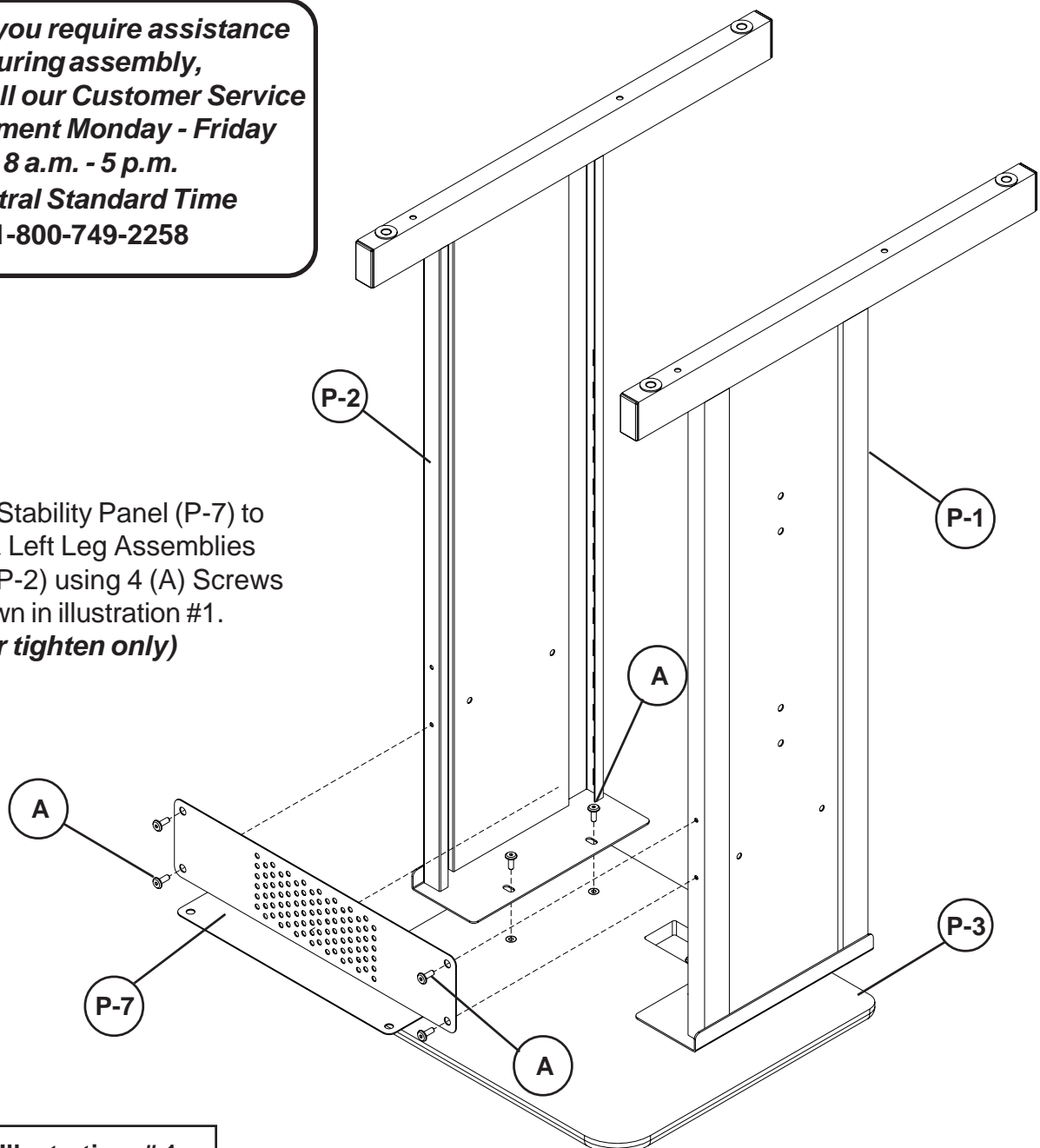

**Illustration # 1**

4.) Align 4 each Angle Brackets (P-8) with the edge of the Middle Shelf (P-6) and attach using 4 each (A) Screws as shown in illustration #2. (**Finger tighten only**)

Illustration # 2

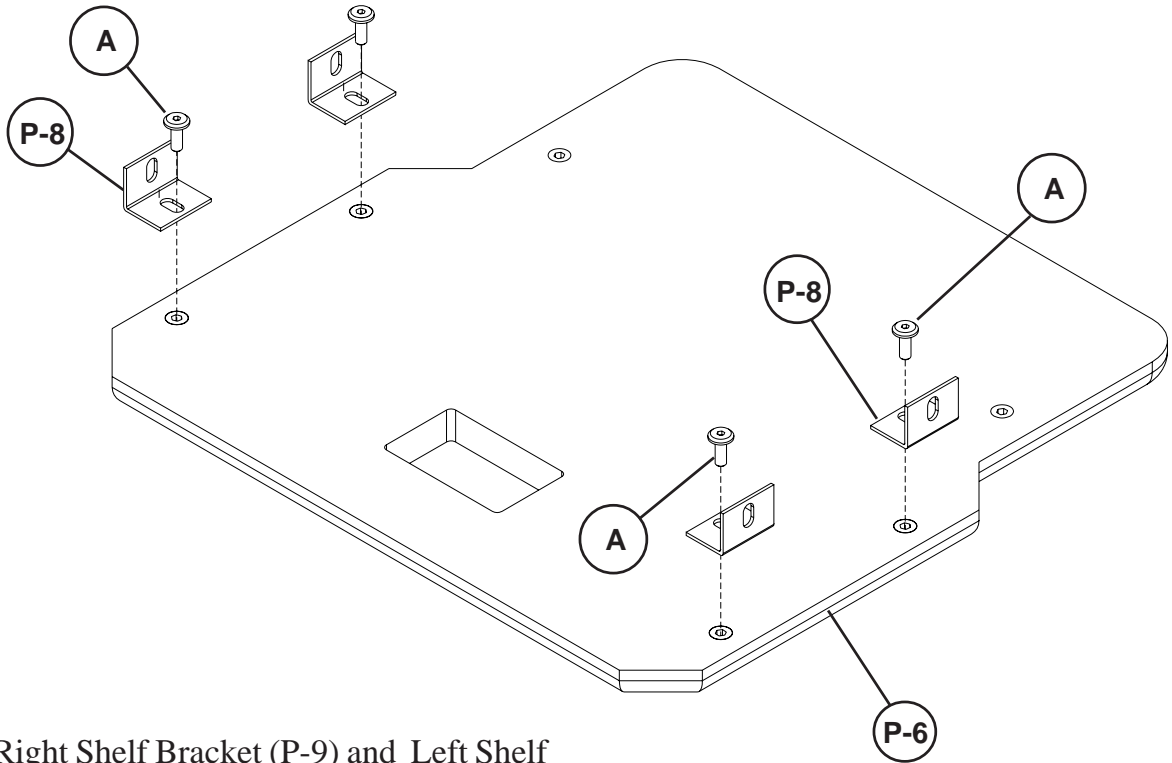

5.) Attach Right Shelf Bracket (P-9) and Left Shelf Bracket (P-10) to Laptop Shelf (P-4) using 4 Flat Head screws (A) as shown in illustration # 4.

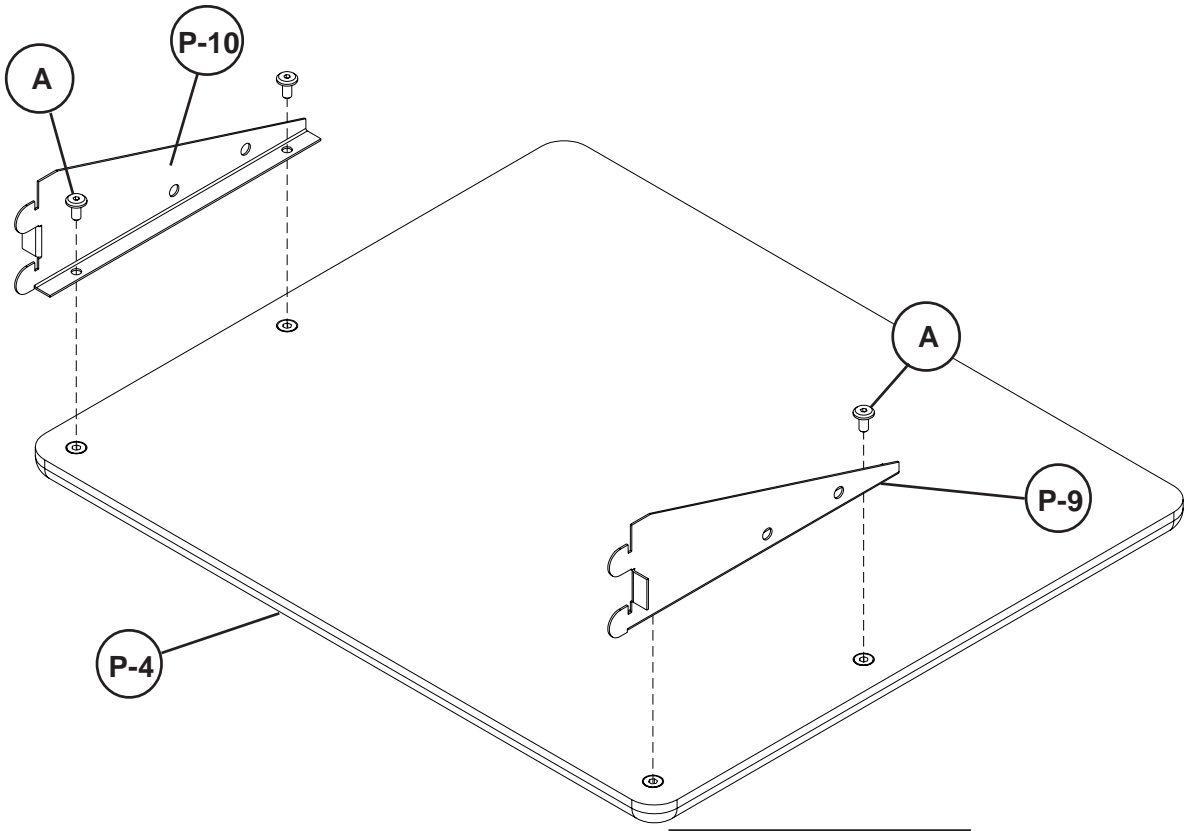
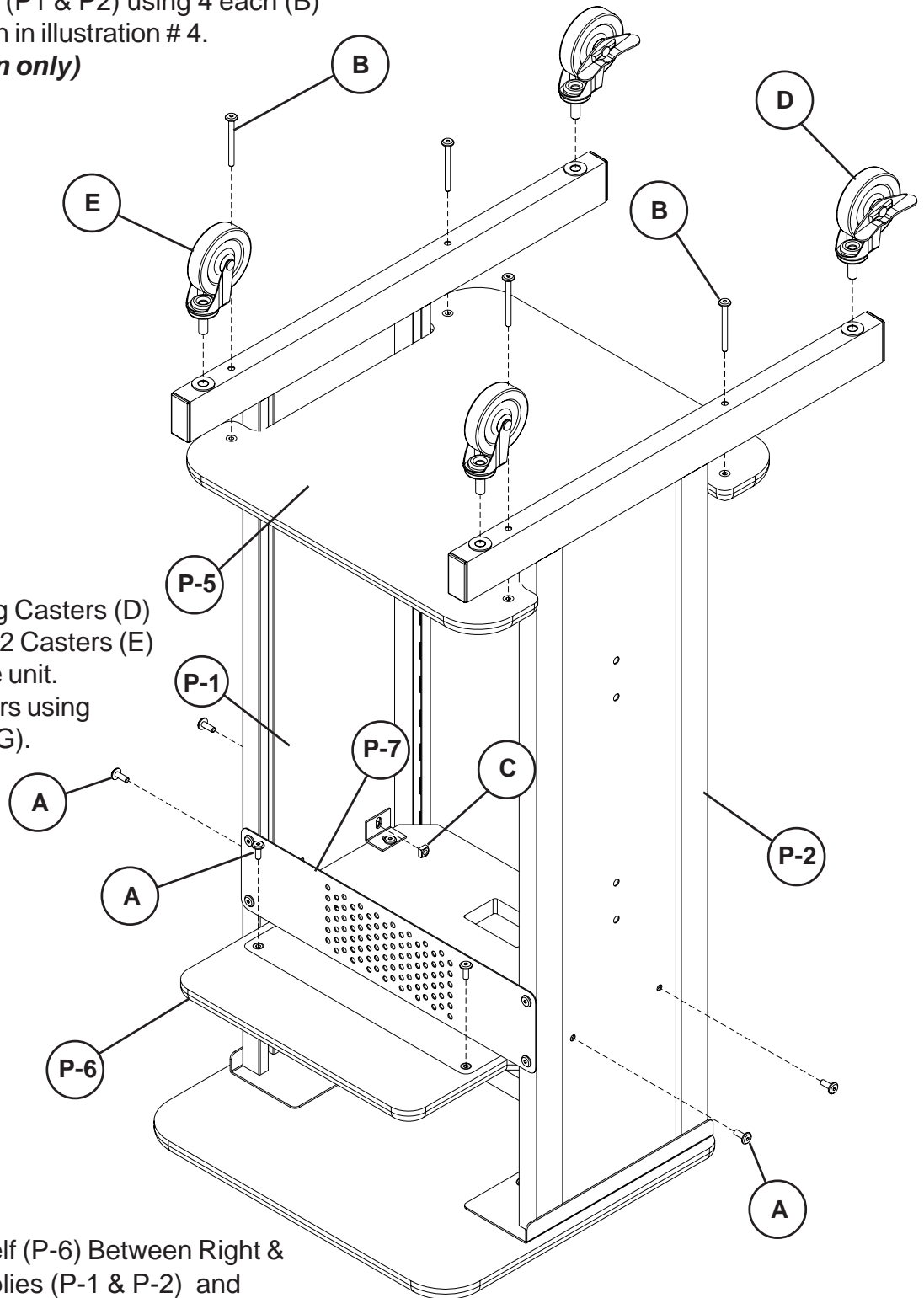

Illustration # 3

- 6.) Attach Lower Shelf (P-5) to the Right & Left Leg Assemblies (P1 & P2) using 4 each (B) screws as shown in illustration # 4.  
**(Finger tighten only)**



- 7.) Attach 2 Locking Casters (D) to the front, and 2 Casters (E) to the back of the unit. Tighten all Casters using Caster Wrench (G).

- 8.) Slide Middle Shelf (P-6) Between Right & Left Leg Assemblies (P-1 & P-2) and attach Middle Shelf (P-5) using 4 each (A) screws and 4 each (C) Square Nuts as shown in illustration # 4. Secure Middle Shelf (P-6) to Stability Panel (P-7) using two screws (A).

- 9.) *(Tighten all the screws at this time using Allen Wrench (F)).*

10.) To install Grommets (E) in LCD Platform (P-3) and Middle Shelf (P-6), separate parts and press Grommet Sleeve in rectangular openings as shown in illustration # 5.

11.) Snap 2 plastic Caps over top of Sleeve as shown in illustration # 5.

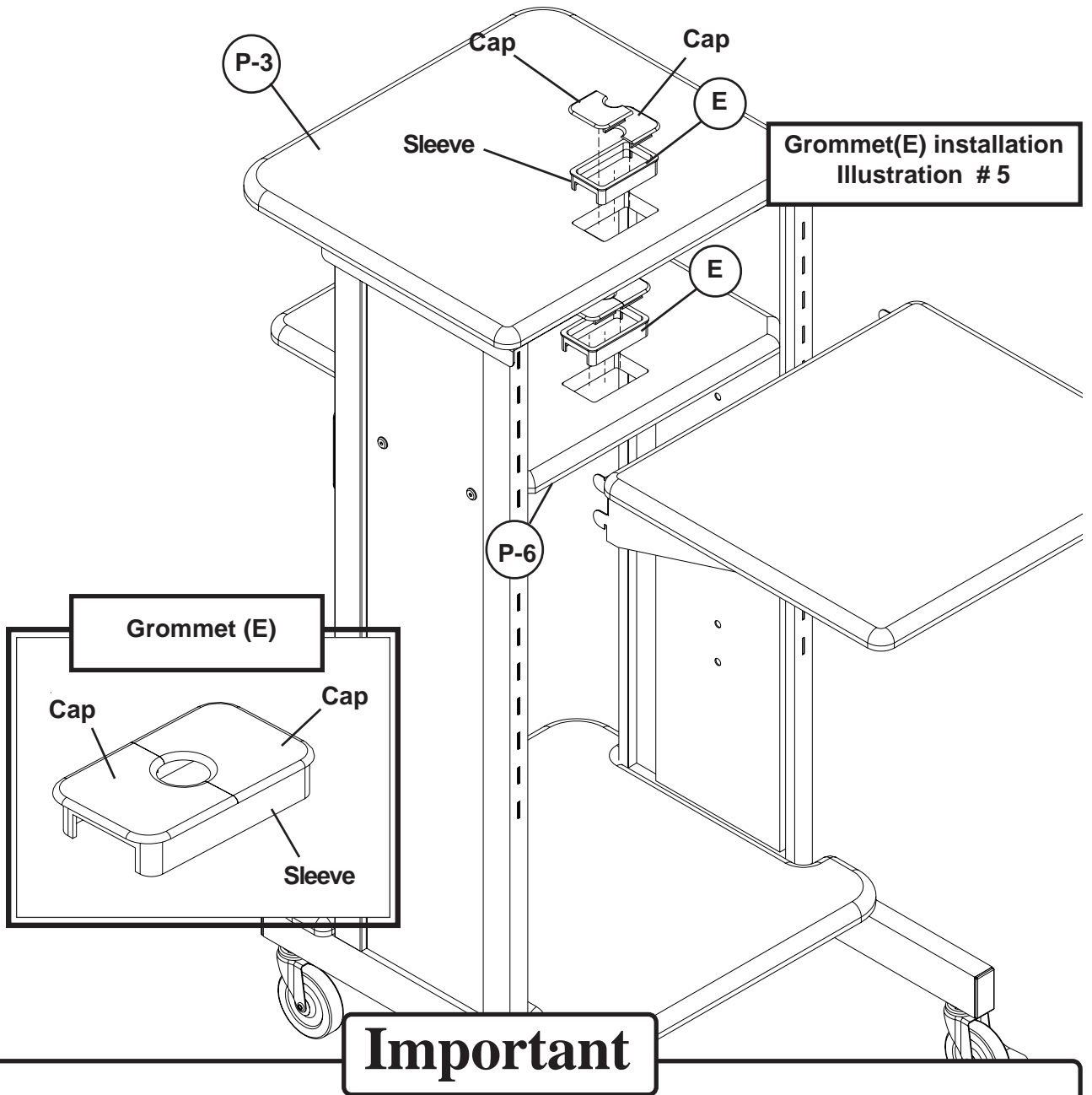

The Balt product you have purchased is guaranteed against material and workmanship defects. This guarantee extends 1 year from date of purchase. Should this product fail to function satisfactorily under normal use due to defect or imperfection, the defective part or product will be replaced. Damage caused by common carriers during shipment is not included in this guarantee.

**This guarantee sets forth all applicable guarantees and remedies. No other warranty, expressed or implied shall apply. Failure to follow instructions found in Important Information Section of Owner Sheet shall void the guarantee. Consequential or incidental damages and or costs are not refundable.**