

Installation and Assembly - Adapter Bracket for VESA® 200 x 200 Screens

Model: PLP-V2X2

IMPORTANT! Read entire instruction sheet before you start installation and assembly.

Maximum Load Capacity : 125 lbs (57 kg)



This product is intended for use with UL Listed products and must be installed by a qualified professional installer.

Parts List

Description	qty.	part#
A adapter bracket	1	200-1721
B M6 x 12 mm socket pin screw	4	520-1050
C 4 mm allen wrench	1	560-9646
D M6 x 20 mm socket pin screw	4	520-9554
E M6 x 30mm socket pin screw	4	520-1067
F M4 x 8 mm socket pin serrated washer head screw	4	510-1005
G #10 washer	4	540-9400
H M4 x 12 mm socket pin serrated washer head screw	4	510-1079
I M5 x 10 mm socket pin screw	4	520-1063

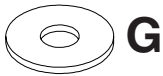
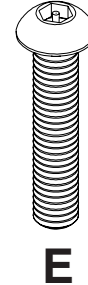
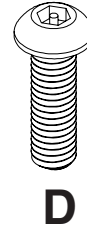
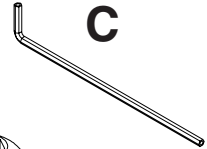
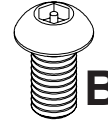
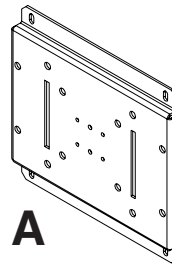

Used with specific mounts only



Some parts may appear slightly different than illustrated.

⚠ WARNING

- Do not overtighten! Overtightening may cause permanent damage to the screen. Torque to 26-35 in • lb (30-40 kg • cm).

- Begin with shortest length screw (**B** or **F**), hand thread through adapter plate into screen as shown below. Screw must make at least three full turns into screen insert and fit snug into place. Do not over tighten. If screw cannot make three full turns into screen insert, select a longer length screw (**D**, **E** or **H**). Repeat for remaining holes. If you have any questions, please call Peerless customer care at **1-800-865-2112**.

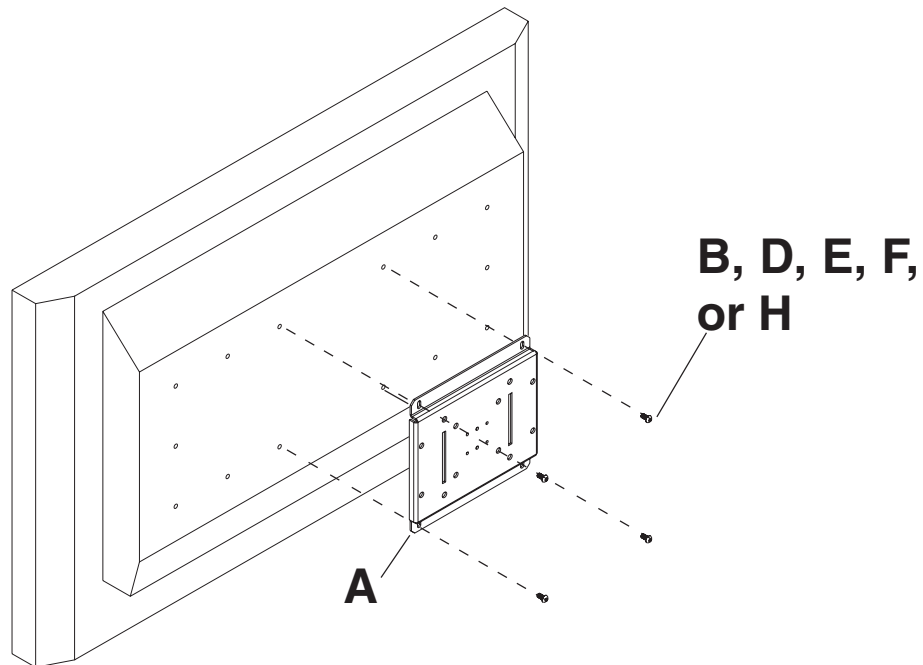

#10 washer (**G**) is only to be used with M4 x 8 mm socket pin serrated washer head screw (**F**) or M4 x 12 mm socket pin serrated washer head screw (**H**).

Washer goes between screw and adapter plate.

