

SA771PU

SmartMount® Articulating Wall Arm for 37"-71" Flat Panel Screens

From any angle, this wall arm mount reflects remarkable form and function. Extending the flat panel screen up to 27.55" (700mm) from the wall and allowing for a full 180° of side-to-side motion for viewing in any part of the room. Fine-tuning of the installation is simple with its side-to-side screen leveling and 1" (25mm) of vertical adjustment features that help achieve installation perfection. This articulating arm also provides screen centering on the wall plate and integrates a desirable cable management system, centering the TV on the wall when retracted and organizing and protecting the cables at all times. Designed and built in the USA, this mount maintains the same brilliant look as the entire SmartMount® 700 Series line of Articulating and Pivot Wall Arm Mounts.



Screen size: 37"-71" (94-180cm)



Max load: 200lb (91kg)

FEATURES

- Universal design provides compatibility for 37" to 71" (94-180cm) flat panel screens with mounting patterns up to 44.45" x 26.03" (1129 x 661mm)
- Screen can be held as close to the wall as 4.43" (113mm) or be extended as far as 27.55" (700mm)
- Integrated cable management contains, protects and conceals cables for a clean clutter-free look
- One-touch tilt allows for +15°/-5° without the use of tools for easy viewing angle adjustment
- Multi-link construction allows for a full 180° range of motion
- ±5° of roll allows for post installation leveling
- Landscape to portrait flat panel screen orientation without needing to remove the screen
- 1" (25mm) vertical adjustment for screen position fine tuning
- Minimalistic wall plate footprint for increased wall access and improved aesthetics
- Horizontal screen adjustment up to 4.5" (114mm) for perfect screen placement

CLEAN APPLICATION

Built in cable management system keeps cables organized and protected

VIEWING FLEXIBILITY

Arm extends up to 27.55" (700mm) from wall

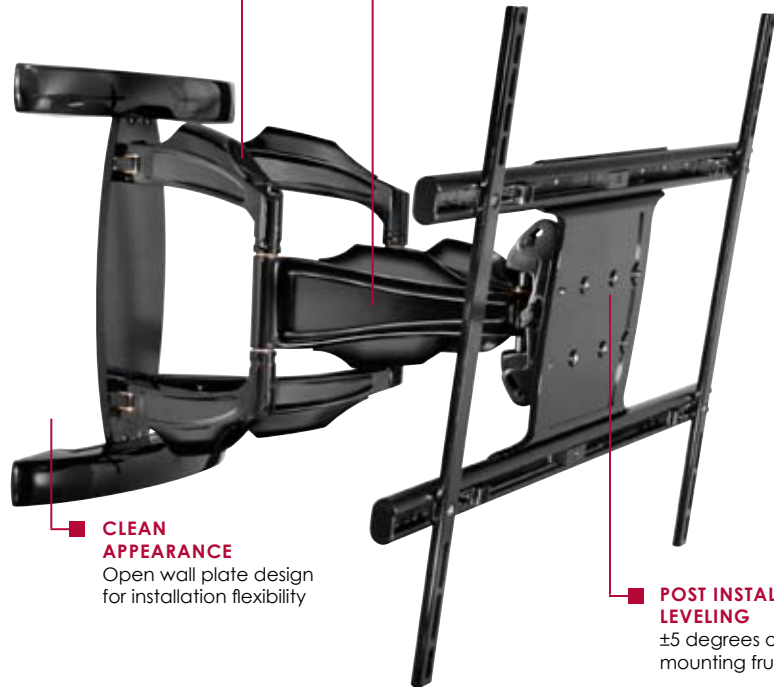

CLEAN APPEARANCE

Open wall plate design for installation flexibility

POST INSTALLATION LEVELING

±5 degrees of roll eases mounting frustration



Arm retracts to just 4.43" (113mm) and extends up to 27.55" (700mm) from wall

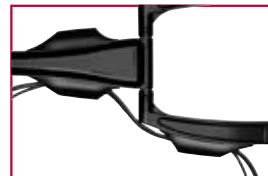

1" (25mm) clearance per channel for clean and simple cable management



1" (25mm) of vertical adjustment for post-installation fine tuning



RoHS



CLICK: www.peerlessmounts.com

CALL: 800.865.2112

FAX: 708.865.2941

peerless®

SA771PU Articulating Wall Arm for 37" to 71" (94-180cm) Flat Panel Screens

Product Specifications

	DIMENSIONS (W x H x D)	PRODUCT WEIGHT	LOAD CAPACITY	FINISH	AVAILABLE COLORS
SA771PU	34.38" x 20.23" x 4.43"-27.55" (873 x 514 x 113-700mm)	63lb (28.6kg)	200lb (90kg)	Scratch resistant fused epoxy	SA771PU: Gloss Black

Package Specifications

	PACKAGE SIZE (W x H x D)	PACKAGE SHIP WEIGHT	PACKAGE UPC CODE	PACKAGE CONTENTS	UNITS IN PACKAGE
SA771PU	35.75" x 21.25" x 6.125" (908 x 540 x 156mm)	68lb (31kg)	SA771PU: 735029266624	Mount, wall and screen attachment hardware, installation instructions, large screen adapters	1

Accessories

- ACC925:** Security Fastener Pack
- ACC415:** Metal Stud Accessory Pack

All dimensions = inch (mm)

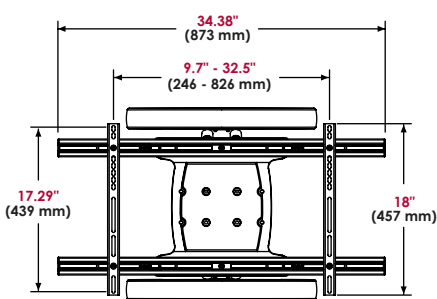

FRONT VIEW

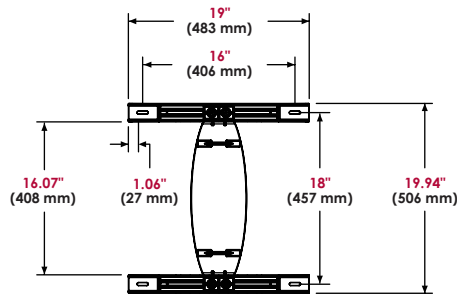

WALL PLATE DETAIL

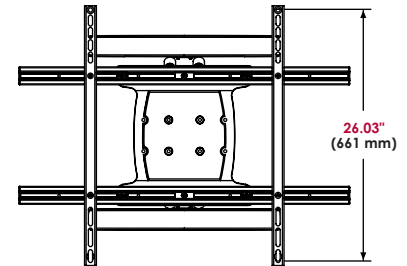

FOR USE WITH 65" SHARP DISPLAYS

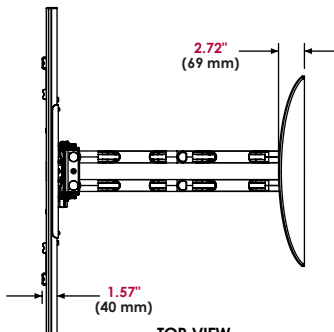

TOP VIEW

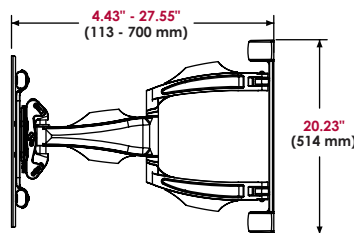

SIDE VIEW

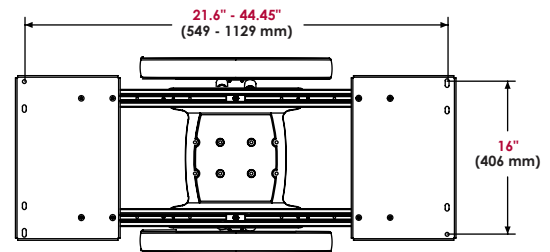

FOR USE WITH 65" PANASONIC DISPLAYS

ARCHITECTS SPECIFICATIONS

The SmartMount Articulating Wall Mount shall be a Peerless model SA771PU and shall be located where indicated on the plans. It shall feature scratch resistant black or silver fused epoxy finish. Assembly and installation shall be done according to instructions provided by the manufacturer.