

DST360

Flat/Tilt Universal Wall or Ceiling* Mount with Computer/Media Controller Storage

For 26" to 60" (66 to 152 cm) flat-panel displays

* Works with any standard EXT, ADD, or ADJ extension columns and ceiling mounts (sold separately)

The DST360 offers a "single-box" solution to digital signage and public space flat panel installations. This versatile solution enables ceiling or wall mounting, it provides plenty of space for a computer or media box storage and allows access to the media device without having to remove the display. Designed for ease-of-assembly and security this mount incorporates a step-by-step installation instructions and includes security option that ensures the display stays in place. Enhancing effectiveness of the mounted display, this product incorporates a built-in swivel** 360 degrees that positions the display at the perfect angle for optimal effectiveness.

**Ceiling mount application



TV size: 26"-60" (66-152 cm)



Max load: 150 lb (68 kg)

FEATURES

- Ideal for wall or ceiling mounted applications
- Universal mounting in either portrait or landscape orientation
- Built-in swivel up to 360° allows for optimum viewing angle for ceiling mount applications only
- Flat and tilt wall mount functionality (up to 20° tilt)
- Available area within mount for housing a computer or media controller device 15" x 9" x 3" (381 x 229 x 76 mm)
- Mount folds open for easy access to the computer or media controller without removing the display
- Access panel opens to a full 20° for serviceability, replacement, repair or maintenance
- Clean profile design hides wiring and mount within enclosed wall plate
- Built in adapter plate supports VESA® 100 x 100, 200 x 100 and 200 x 200 mm
- Works with all PLP-style VESA® mounting hole adapter plates
- Includes hardware for installation to wood*** and metal**** studs, concrete or cinder block

** Mounts to single stud or 16" stud centers (wall application)

*** Rated to 200 lb (90.72 kg) display max using dual metal stud, or 60 lb (27.22 kg) display max using single metal studs

- Security screws prevent tampering and theft

FLEXIBLE VIEWING

Ceiling mounted:
built-in swivel, up to 360°, allows for optimum viewing angle

Wall mounted:
flat and tilt options with up to 20° tilt

■ **UNIVERSAL MOUNTING OPTIONS**
Ideal for wall or ceiling installations

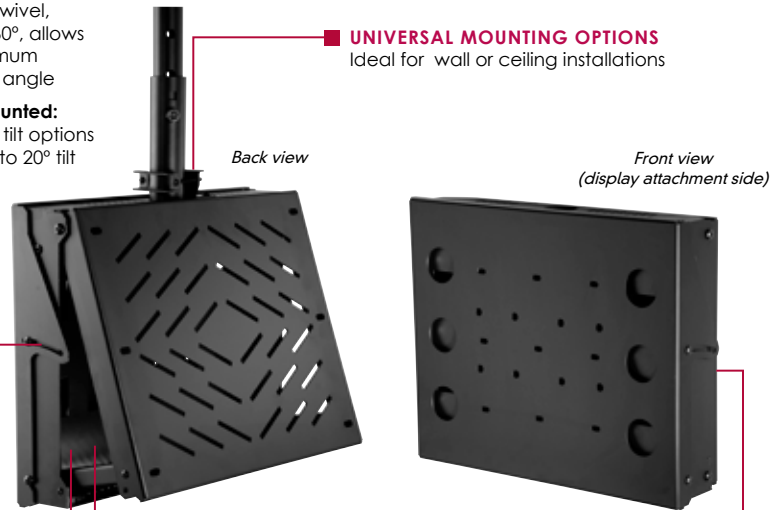

■ **MEDIA CONTROLLER HOUSING**
Available area within mount for housing a computer or media controller device

■ **SERVICE ACCESSIBILITY**
Mount folds open 20° from the bottom for computer or media controller service access without removing the display

■ **CLEAN APPLICATION**
Internal cable management delivers a clean, clutter-free side profile and rear view



Media controller storage area within mount



Ceiling mounted side view with forward tilt



Built-in ventilation and cable management

Model Numbers

WARRANTY: Limited 5-year

DST360 Flat/Tilt Universal Wall or Ceiling* Mount with Computer/Media Controller Holder

* Works with any standard EXT, ADD, or ADJ extension columns and ceiling mounts (sold separately)

Product Specifications

	DIMENSIONS (W x H x D)	PRODUCT WEIGHT	LOAD CAPACITY	FINISH	AVAILABLE COLORS
DST360	18.6" x 16.5" x 4.3" (472 x 419 x 109 mm)	31.5 lb (14.29 kg)	150 lb (68 kg)	Scratch resistant fused epoxy	Black

Package Specifications

	PACKAGE SIZE (L x W x H)	PACKAGE SHIP WEIGHT	PACKAGE UPC CODE	PACKAGE CONTENTS	UNITS IN PACKAGE
DST360	24.5" x 12.25" x 27.75" (622 x 311 x 705 mm)	40.5 lb (18.37 kg)	735029264521	Computer/media player holder box, access plate, adapter plate, fastener packet	1

Accessories

Works with all PLP-style VESA® mounting hole adapter plates

Works with any standard EXT, ADD, or ADJ extension columns and ceiling mounts (sold separately)

All dimensions = inch (mm)

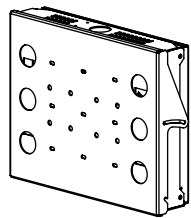

FRONT ISO VIEW

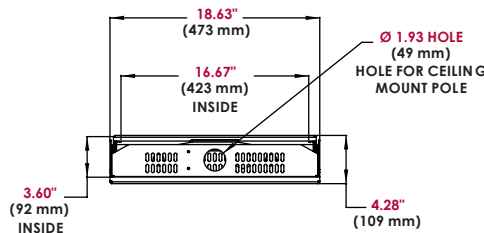

TOP VIEW

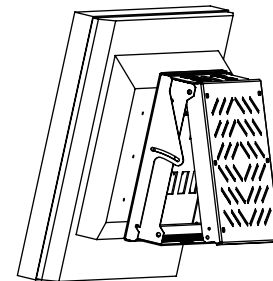

ACCESS ISO VIEW

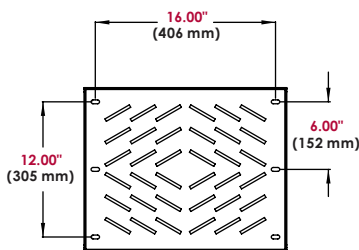

BACK VIEW

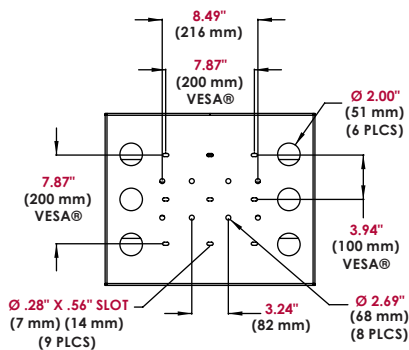

FRONT VIEW

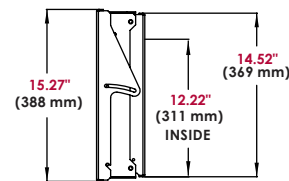

RIGHT VIEW

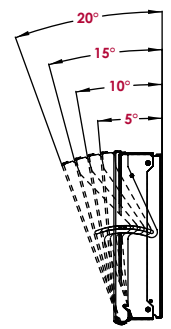

TILTS RANGES VIEW

ARCHITECTS SPECIFICATIONS

The enclosed flat/tilt wall mount shall be a Peerless model DST360 and shall be located where indicated on the plans. It shall be constructed of heavy gauge cold rolled steel and finished with scratch resistant Black Fused Epoxy. Assembly and installation shall be done according to instructions provided by the manufacturer.