

48 Unit Management Cart

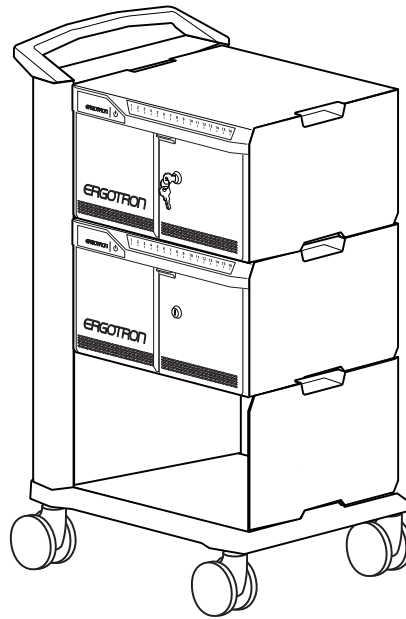

32 Unit Management Cart



www.ergotron.com

USA 1-800-888-8458

Europe +31 (0)33-45 45 600

China 400-120-3051

Table of Contents





Hazard Symbols Review	2
Components & Tools	2
Features	3
Tablet Charging	4
LED and Syncing	8
Cable Replacement Instructions	7
Cleaning and Maintenance	11
Specifications	12
Service and Warranty Information	12

Apple, iPad, iPad Air, iPad mini, iPad Pro, iTunes, Lightning, Retina and Macintosh are trademarks of Apple Inc., registered in the U.S. and other countries.

Made for iPad, means that an electronic accessory has been designed to connect specifically to iPad, and has been certified by the developer to meet Apple performance standards. Apple is not responsible for the operation of this device or its compliance with safety and regulatory standards. Please note that the use of this accessory with iPad may affect wireless.

Safety Hazard Review

These symbols alert users of a safety condition that demands attention. All Charging and Managed Cart users should be able to recognize and understand the significance of the following Safety Hazards if encountered on the Cart or within Cart documentation. Children who are not able to recognize and respond appropriately to Safety Alerts should not use the Cart without adult supervision!

Symbol	Signal Word	Level of Hazard
	NOTE	A NOTE indicates important information that helps you make better use of your Cart.
	CAUTION	A CAUTION indicates either potential damage to hardware or loss of data and tells you how to avoid the problem.
	WARNING	A WARNING indicates either potential for property damage, personal injury, or death.
	ELECTRICAL	An Electrical indicates an impending electrical hazard which, if not avoided, may result in personal injury, fire and/or death.

Components

One Tablet Management Cart

2 Keys

Includes 32/48 USB to Lightning Cables

Features

48 Unit Management Cart

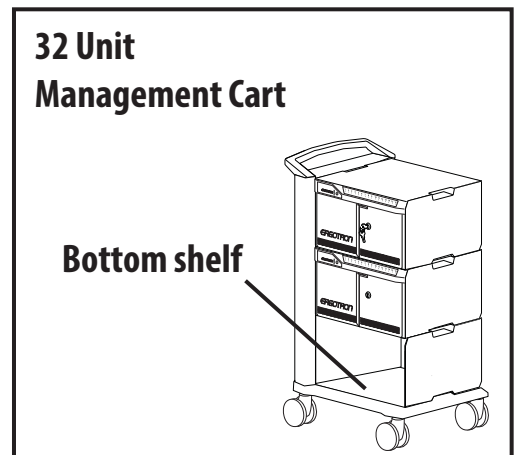
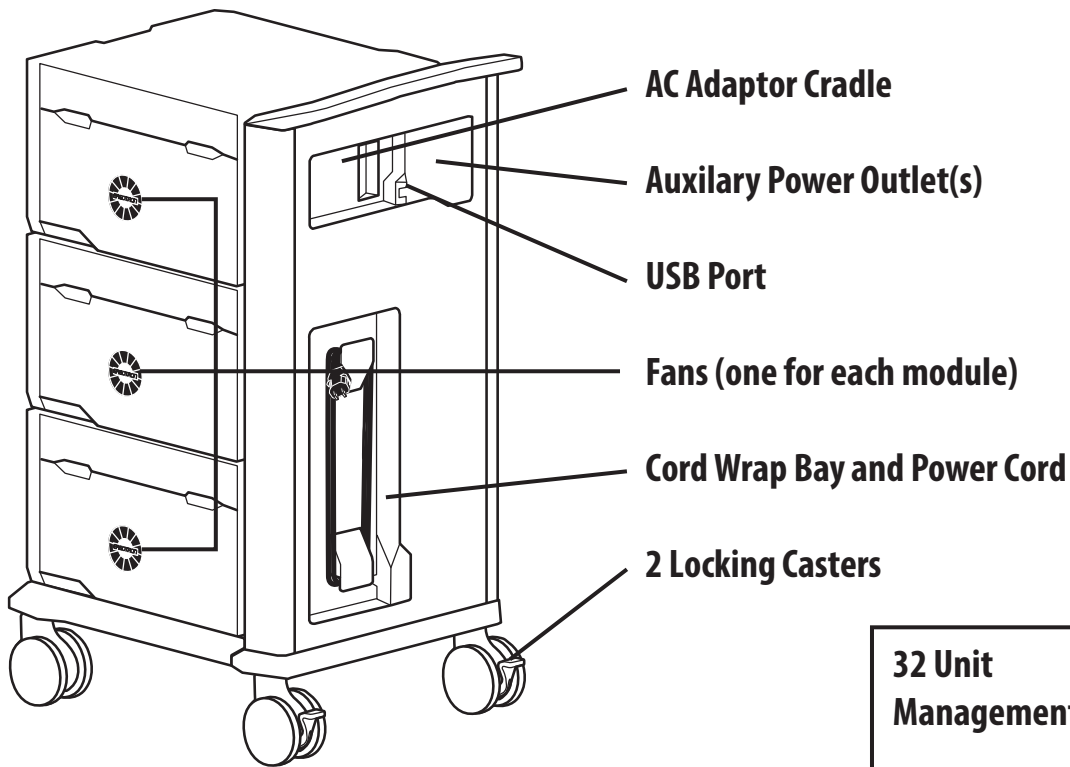
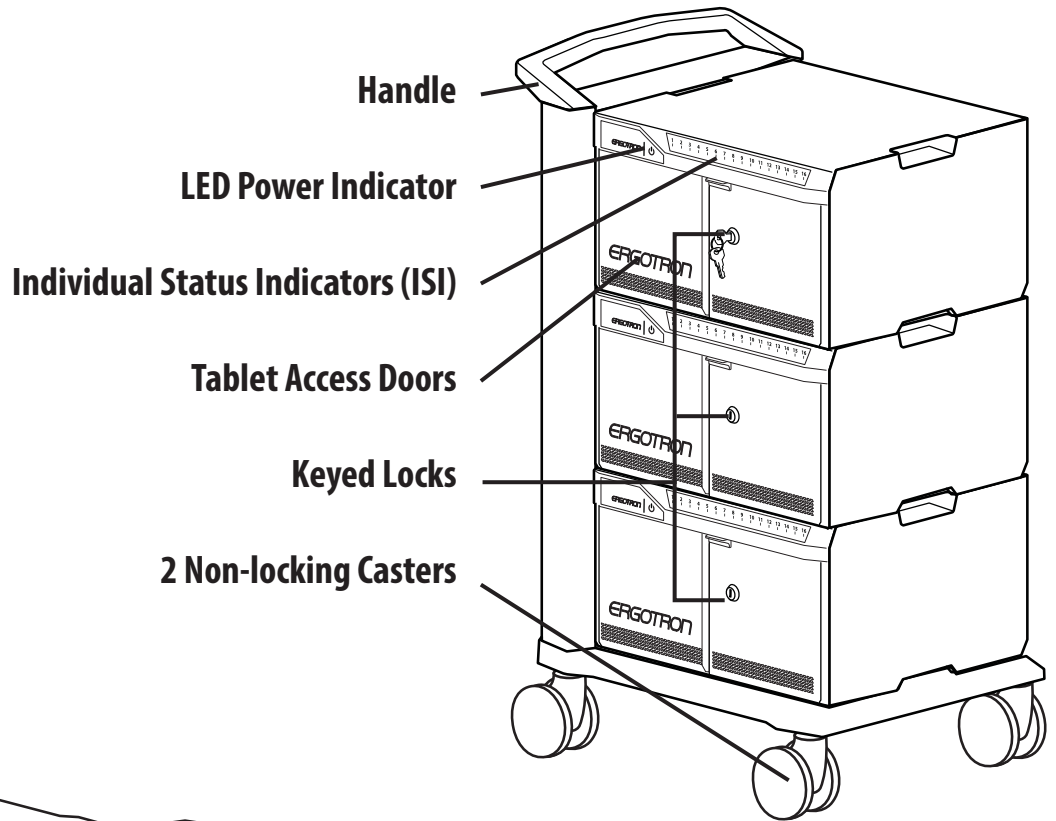

Tablet Charging

1

Insert iPad devices into module. Connect the tablet USB charging cables to the iPad devices. Repeat Steps 1 - 10 for the other modules.

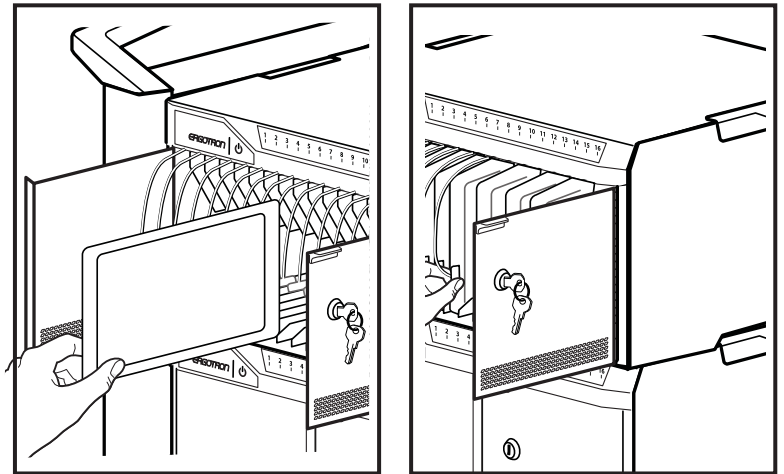

2

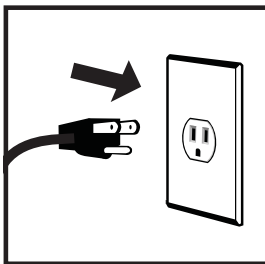

To begin charging the tablets, plug in the Cart power cord.





The power cord is used to turn the Cart power on and off. Charging occurs whenever the cart power cord is connected UNLESS a Macintosh® or PC notebook USB cable is connected to the cart for syncing.



NOTE: the cart power cord acts as the connect/disconnect device switching power off and on.

LED - Indicators

Power Indicator – communicates sync and charge status with the following signals:

	Off	=	No power to the module.
	On - solid	=	iPad devices are charging.
	On - slow blink	=	Computer is plugged into auxillary USB outlet and iPad devices are ready to sync or are syncing.
	On - fast blink	=	Fault Status. Please make sure all cables are seated correctly within cable drawer and cart is operating within specified operating temperature. Contact Ergotron Customer Support if problem continues.

Individual Status Indicators (ISI) – sequentially numbered LEDs corresponding to each tablet in the module:

 **Green = Fully charged.**

 **Amber = Charging in progress.**

 **NOTE:** if module is syncing all ISIs will be green.

Tablet Syncing



NOTE: Complete the Tablet Charging instructions before syncing. iPad devices should be charged at least 50% before starting the syncing process.

Syncing can be done using iTunes® or the Apple Configurator program available for the Macintosh® computer. Please reference www.Apple.com for more information.

NOTE: The devices will not charge while syncing is in process. To return to charge mode, unplug the USB cable from the Tablet Management Cart USB port when syncing is complete.

The iPad devices will mount as USB devices when the A to B USB cable (not included) is connected to a host notebook via the USB port on the exterior of the Tablet Management Cart.

If using iTunes, please see separate iTunes setup instructions available on the Ergotron website **Tablet Management Cart** product page.

Syncing

- 1 Place your Apple device, power adaptor and a USB cable on the cart work top.

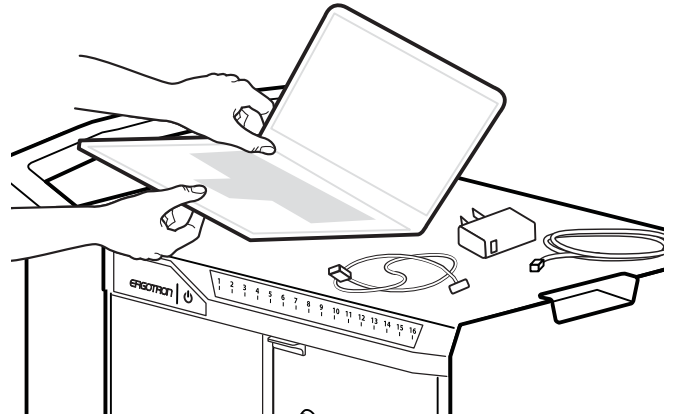

- 2 Plug the USB and power adaptor cables into the notebook; route the ends of the cables down the side of the cart, and strap the power adaptor into the recessed area to store.

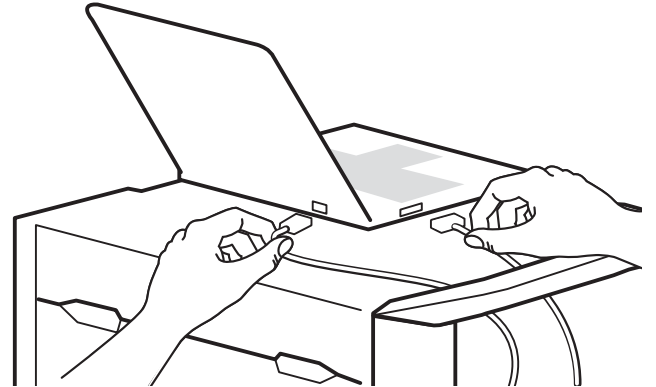

- 3 Connect the notebook USB cable to the port on the side of the cart.

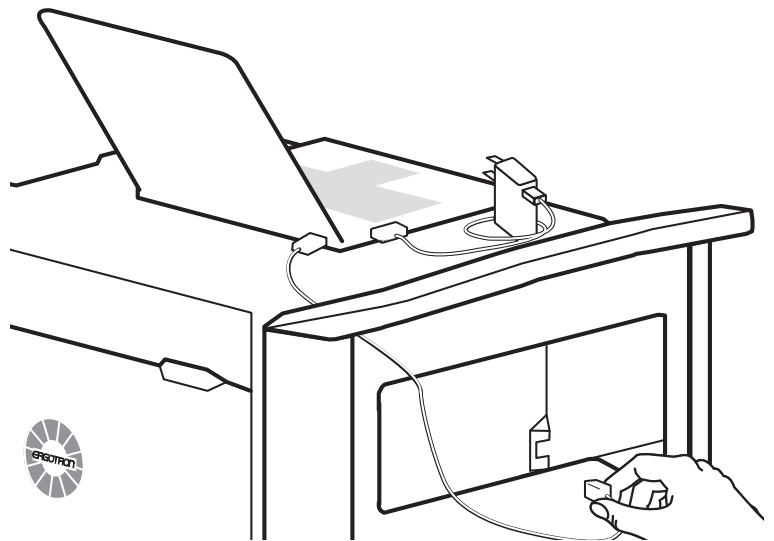

- 4 Connect the Apple device power adaptor into the auxiliary outlet on the side of the cart. Tuck the access cables into the recessed area. Switch on the notebook power to begin syncing.

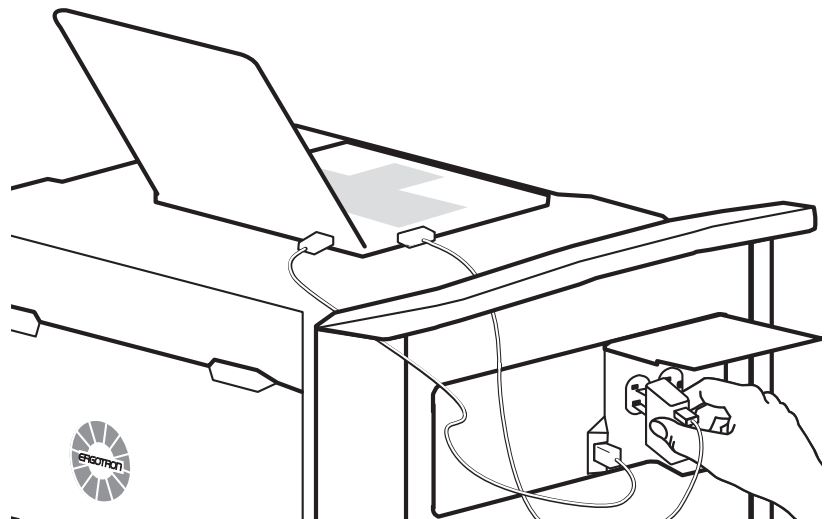

Cable Replacement Instructions

- 1** Make sure the Module power cord is disconnected from wall power supply before proceeding.

Unlock the module and open the doors.



NOTE: the Module power cord acts as the connect/disconnect device switching power off and on.

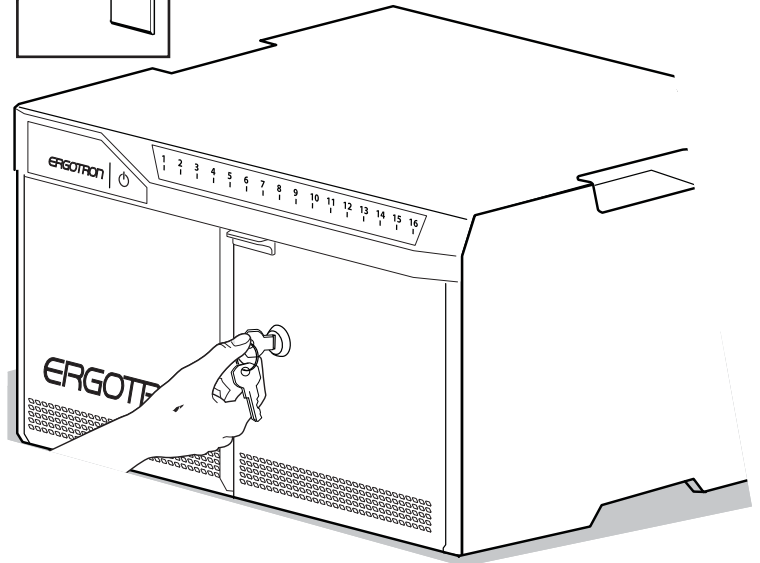
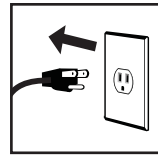

- 2** Use a Phillips screwdriver to remove the two screws located on the interior sides of the module; save screws to reinsert later.

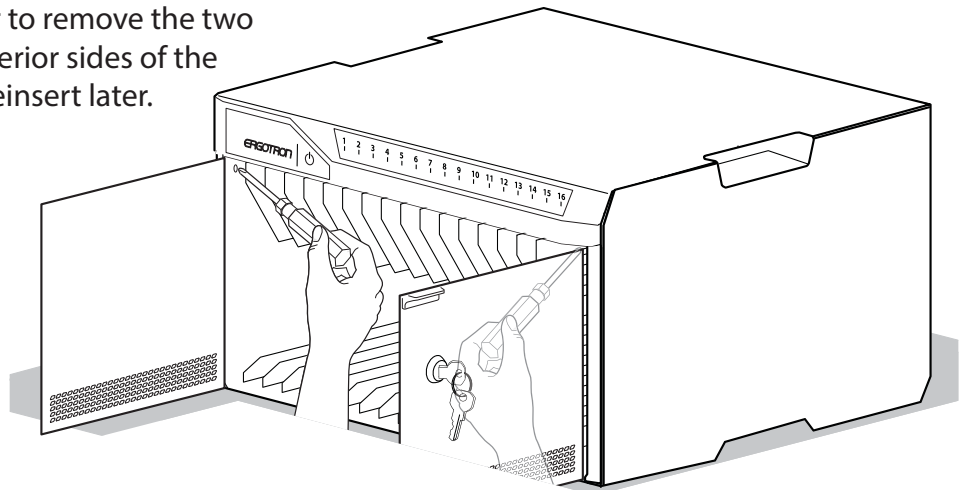

- 3** Partially slide out the module drawer. You'll need to unplug two cables before sliding the drawer completely out. Open the strap to access the two cables.

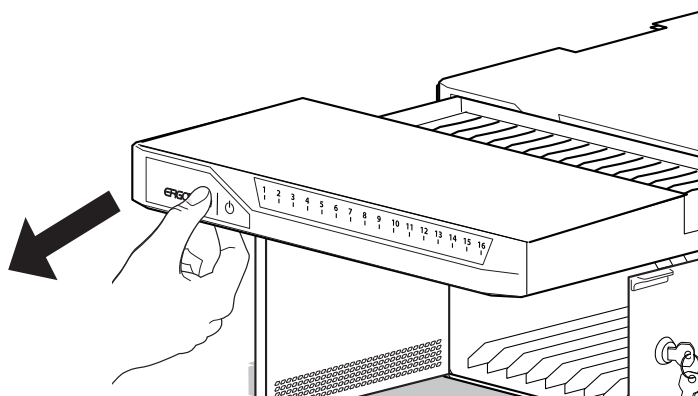

- 4** Unplug the USB and DC power cables (push up on the lever under the DC connector to release). The drawer can now be removed.

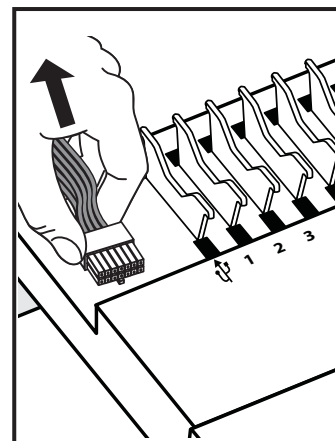
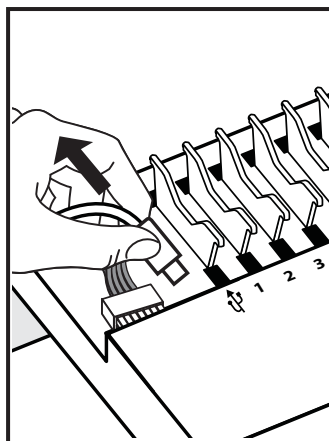

- 5** Unwind and remove the existing USB cables from drawer.

NOTE: Please recycle or dispose the removed cables in a responsible manner.

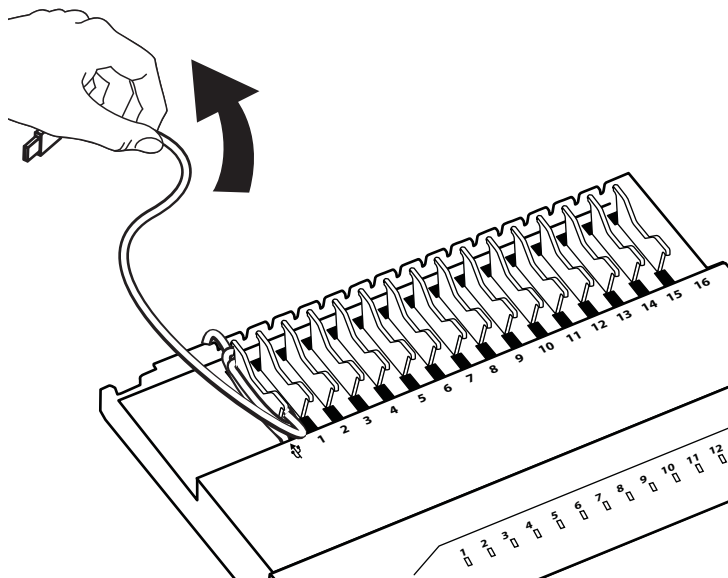

6

Connect the USB cable to the USB port.

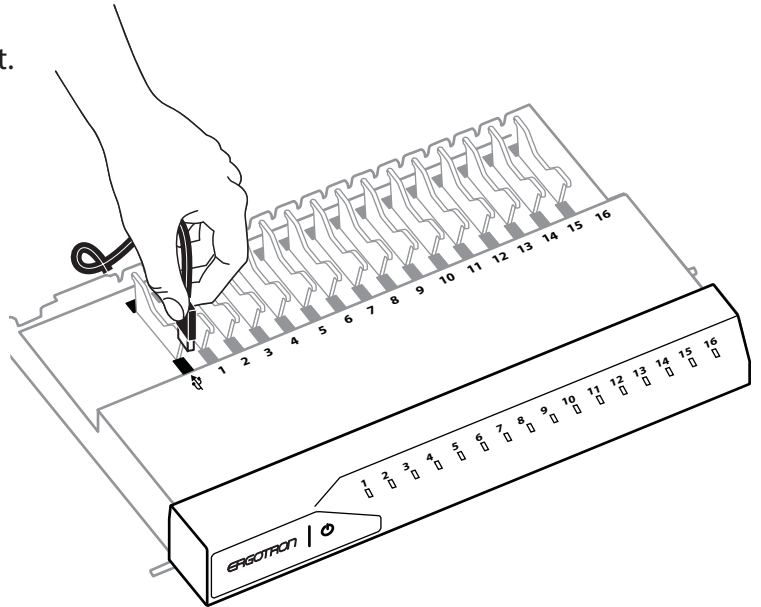
**7**

Place the drawer upside down on the cart top and route the USB cable through the slot on the back of the drawer and under the hooks toward the front. Make sure there is no slack in the cable. All excess cable should hang from the hooks.

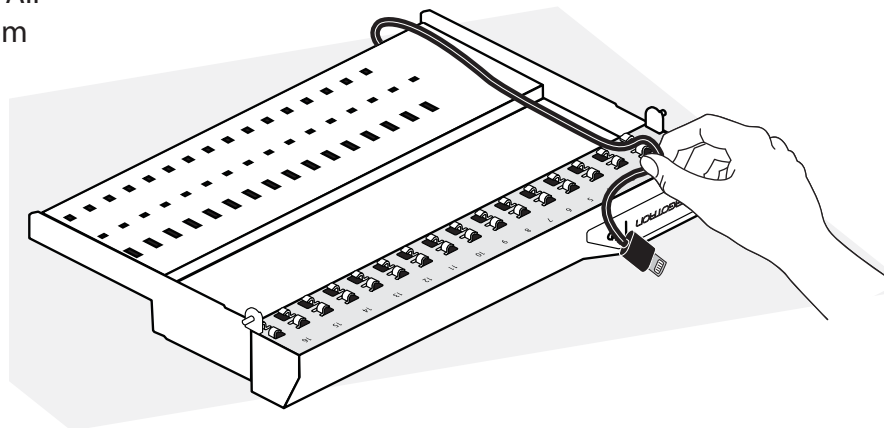
**8**

Repeat USB cabling steps 6 through 8 for the rest of the iPad devices going into this module.

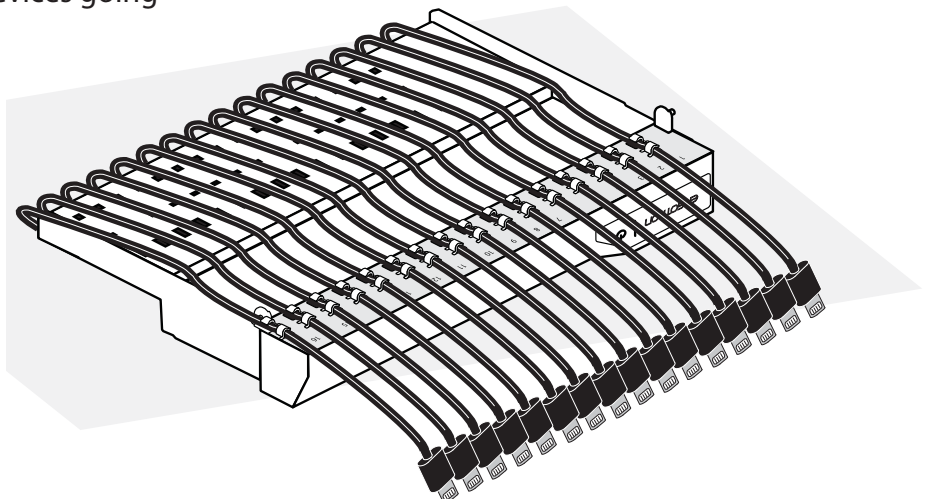

- 9** Slide the drawer partially into the module. Reconnect the USB and DC cables and wrap the straps around the cables.

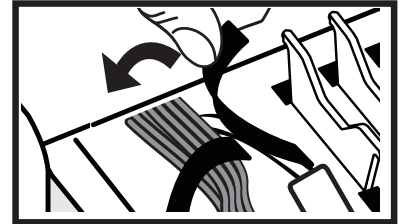
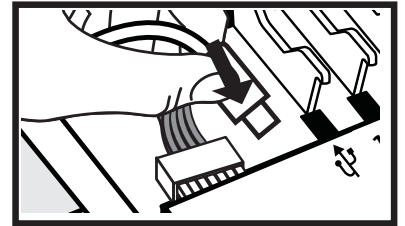
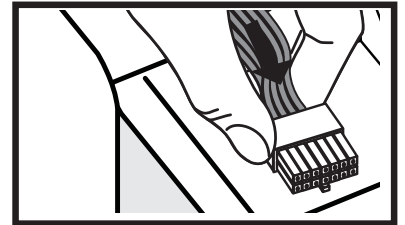
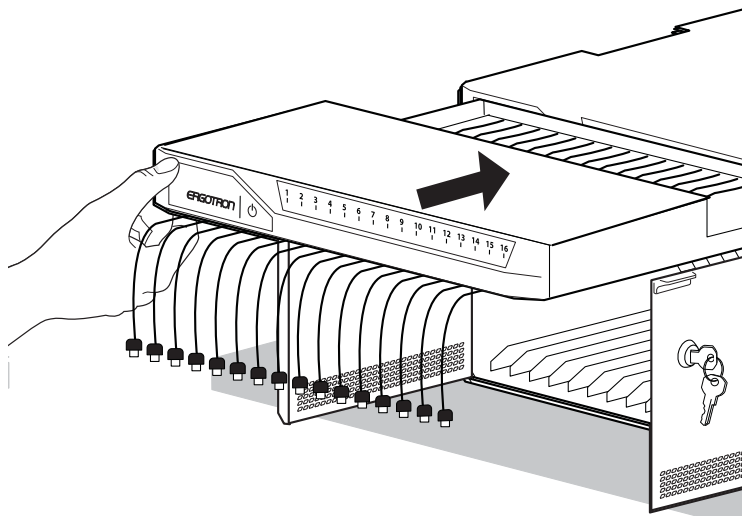

- 10** Slide the drawer completely into the module. Insert the screws removed in step 2 and tighten.

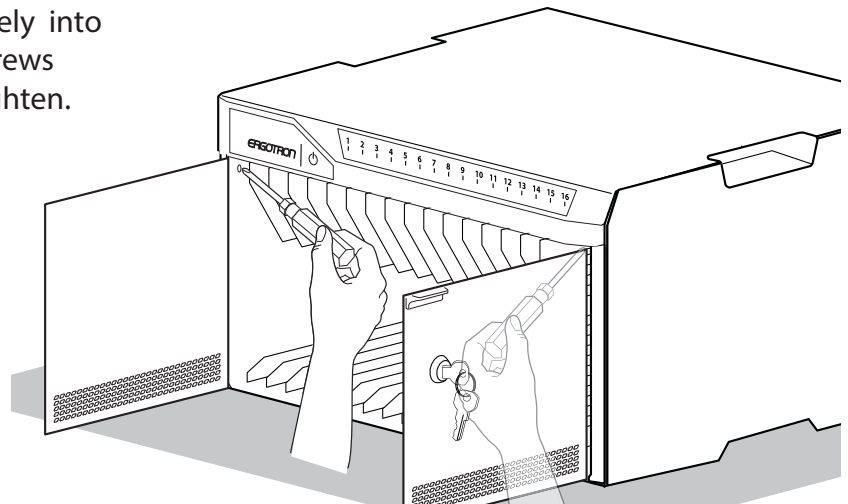

- 11** Insert iPad devices into module. Connect the tablet USB charging cables to the iPad devices.

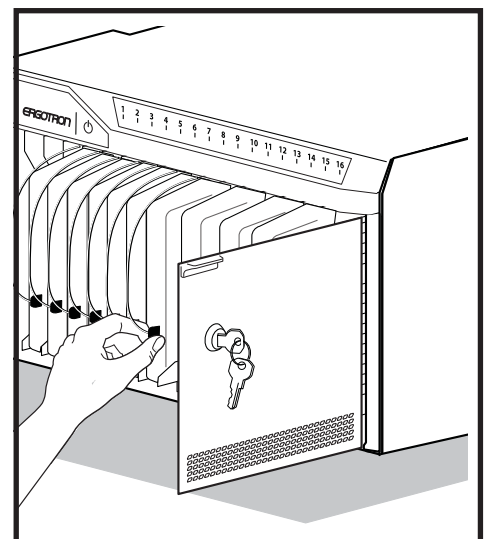
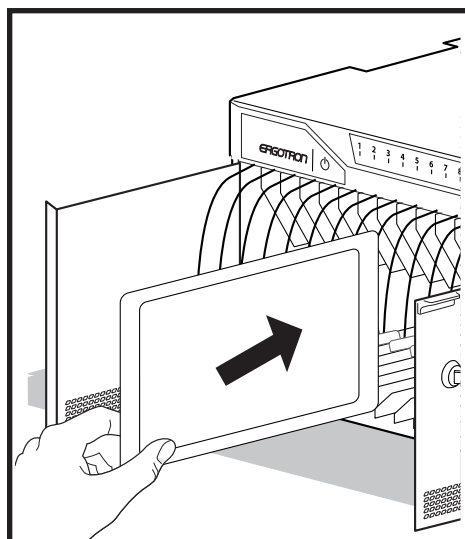

Cleaning and Maintenance

Cart and Equipment Electric Safety

There are specific risks associated with the use of equipment having power cables. You must be aware of, and avoid these risks when the Cart is located in close proximity to children.

 **WARNING:** Failure to observe the following Electrical Safety notices can result in fire or death by electric shock.

 Electrical cables can be hazardous. Misuse can result in fire or death by electrical shock.

- Double Pole / Neutral Fusing
- Inspect power cables thoroughly before each use.
- Do not use cables that are damaged.
- Insert the plug completely into the outlet.
- Grasp the plug to remove from the outlet.
- Do not unplug by pulling on the cable.
- Do not use excessive force to make connections.
- Do not plug the cable into an extension cable.
- Do not remove, bend or modify any metal prongs or pins of cable.
- Do not drive, drag or place objects over the cable.
- Do not walk on the cable.
- Avoid overheating. Uncoil the cable and do not cover it with any material.
- Do not run cable through doorways, holes in ceilings, walls or floors.

 Keep the Cart away from water.

- Do not use it when wet.
- Do not place the Cart in close proximity to flammable liquids or gases.

 This cart is intended for use only with loading as indicated. Use with loads greater than indicated may result in instability causing possible injury.

 The cart power cord acts as the connect/disconnect device switching power off and on.

 **CAUTION:** Changes or Modifications not expressly approved by Ergotron could void the user's authority to operate the equipment.

Cart Use Safety

There are specific risks associated with the use of Cart when moving or stationary (for charging or storage). You must be aware of, and avoid these risks when the Cart is located in close proximity to children.

 **WARNING:** Failure to observe the following Cart Use Safety notices may result in serious personal injury or equipment damage.

Only Adults should move this cart.

- Do not allow anyone to sit, stand, or climb on the Cart.
- Do not lift the Cart from the bottom.
- Do not block the fans and vent openings. To prevent overheating, leave at least 127 mm (5-inch) clearance around fans and vents.
- Regularly inspect and clean the vent openings to eliminate dust accumulation and keep the fans running at optimal performance levels.

The Cart is designed to be used indoors only.

- Do not use the Cart to transport or store equipment other than what has been noted in this guide.
- Do not use the Cart to store liquids or cleaning supplies.
- Do not place heavy objects on the Cart surface or shelf.
 - The maximum weight capacity of the top surface is 11.4 kg (25 lb).
 - The maximum weight capacity of the shelf is 16 kg (35.2 lb).

Moving the Cart

- Before moving the Cart:
 1. Disconnect the power cable from the wall.
 2. Make sure the cable is wrapped and secure.
 3. Close and lock the doors.
 4. Remove items from the top work surface.
 5. Unlock the casters.
- Push (do not pull) the Cart for optimum maneuverability and to prevent muscle strain.
- Do not move the Cart across rough, uneven or irregular surfaces such as gravel.

Parking the Cart

Observe these safety alerts for times when the cart is stationary:

- Do not park the Cart in areas of heavy traffic.
- Do not run cables through doorways, holes in ceilings, walls, or floors.
- Do not run cables across hallways, classrooms, or other areas where they will be walked on.
- Do not leave Cart unattended in areas where children have access.
- Keep Cart doors closed and locked whenever it is unattended or parked for charging or storage.
- Keep Cart casters locked whenever it is unattended.

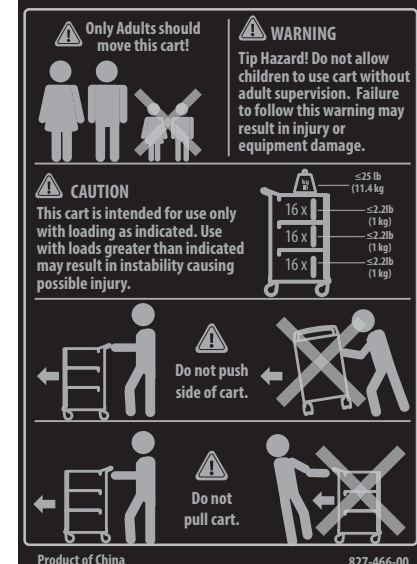
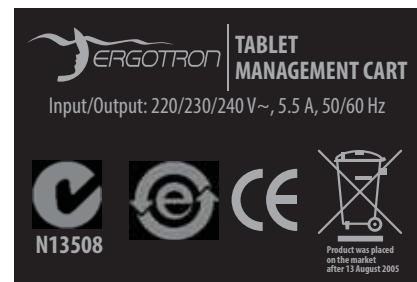

Specifications

This device complies with Part 15 of the FCC Rules. Operation is subject to the following two conditions: 1) This device may not cause harmful interference. 2) This device must accept any interference received, including interference that may cause undesired operation. This Class A digital apparatus complies with Canadian ICES-003. / Cet appareil numérique de la classe A est conforme à la norme NMB-003 du Canada.

この装置は、クラスA情報技術装置です。この装置を家庭環境で使用すると電波妨害を引き起こすことがあります。この場合には使用者が適切な対策を講ずるよう要求されることがあります。 VCCI-A

Cart dimensions

23"W x 18.4"D x 39.3"H (58.4 x 46.7 x 100 cm)

Cart weight (w/o equipment)

32 Unit Cart 100 lbs (45.4 kg)
48 Unit Cart 126.5 lbs (57.4 kg)

Rated weight capacity

Top Work Surface 25 lb (11.3 kg)
Bottom Shelf (32 Unit Carts, only) 25 lb (11.3 kg)

Maximum tablet size

Individual tablet dimensions (including cover):
up to 7.9 H x 11.3 W x 0.85 in D (20.0 x 28.8 x 2.2 cm)
Individual tablet weight:
up to 2.2 lb (1 kg)

LED status indicators (ISI) - Optional feature

Lights indicate power status and syncing activity
32 Unit Cart 32 LED lights
48 Unit Cart 48 LED lights

Cooling/ventilation

One 12-volt DC continuous operation fan in each module

External power outlet(s)

One or two outlets, depending on region
100/120 V~, 3A, 50/60 Hz or
220/230/240 V~, 1.5A, 50/60 Hz

Shipping dimensions

46.1 x 29.9 x 22.8 in (117 x 76 x 58 cm)

Shipping weight

32 Unit Cart 147 lb (67 kg)
48 Unit Cart 175.5 lb (80 kg)

Power system

100/120 V~, 12A, 50/60 Hz or
220/230/240 V~, 5.5A, 50/60 Hz
Depending on region and model of Cart

Tip Test/Angle: 10 degrees

Environmental

Temperature range:
Operating 0° to 30°C (32° to 86°F)
Storage -40° to 60°C (-40° to 140°F)
Relative humidity (maximum):
Operating 10%–90% (non condensing)
Storage 5%–95% (non condensing)
Altitude (maximum): 2000 m (6,562 ft)

Compatibility:

Made for iPad mini 4
iPad Pro (9.7-inch) iPad mini 3
iPad Air 2 iPad mini with Retina Display
iPad Air iPad mini
iPad (5th generation)
iPad (4th generation)

ENGLISH

Service and Warranty

For Service on the Ergotron Tablet Managing Cart
for iPad

Visit www.ergotron.com



NOTE: When contacting customer service, reference the serial number.

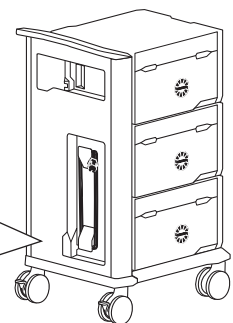

ERGOTRON®

While Ergotron, Inc. makes every effort to provide accurate and complete information on the installation and use of its products, it will not be held liable for any editorial errors or omissions (including those made in the process of translation from English to another language), or for incidental, special or consequential damages of any nature resulting from furnishing this instruction and performance of equipment in connection with this instruction. Ergotron, Inc. reserves the right to make changes in the product design and/or product documentation without notification to its users. For the most current product information, or to know if this document is available in languages other than those herein, please contact Ergotron. No part of this publication may be reproduced, stored in a retrieval system, or transmitted in any form or by any means, electronic, mechanical, photocopying, recording or otherwise without the prior written consent of Ergotron, Inc., 1181 Trapp Road, Eagan, Minnesota, 55121, USA. Patents Pending and Patented U.S. & Foreign. Ergotron is a registered trademark of Ergotron, Inc.

Americas Sales and Corporate Headquarters

St. Paul, MN USA
(800) 888-8458
+1-651-681-7600
www.ergotron.com
sales@ergotron.com

EMEA Sales

Amersfoort, The Netherlands
+31 33 45 45 600
www.ergotron.com
info.eu@ergotron.com

APAC Sales

Tokyo, Japan
www.ergotron.com
apacustomerservice@ergotron.com

Worldwide OEM Sales

www.ergotron.com
info.oem@ergotron.com