

Workrite
ergonomics®



SOLACE SIT-TO-STAND

SIT-TO-STAND

SOLACE

For more than 25 years, Workrite Ergonomics has been helping organizations create happier, healthier and more productive workplaces. We take issues like neck and back pain, blurred vision, and headaches caused by extended computer use seriously, and are committed to helping organizations fight these increasingly common problems.

Workrite's Solace series of products was specifically designed to address these issues. The Solace family, which includes our new Solace 2, Solace Single Surface and Solace Desk Top, has evolved to include a range of solutions designed to address all your Sit-to-Stand needs. It now includes options that offer the greatest level of adjustability and desk space utilization, delivering ergonomic solutions for virtually any budget.

The Solace family of products features simple and quick installation designed to save organizations both time and money and has the flexibility to accommodate a wide variety of users, and deliver stable, customizable workspaces that increase comfort and productivity.

Solace — For the Way You Work



Solace 2 Premium with Dual Monitor Adaptor option



Solace Single

Solace 2 Sit-to-Stand

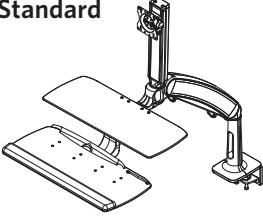
		Model #	Weight	US \$ List	CAN \$ List
Standard	 <p>UB182-25 Keyboard Platform</p> <p><i>Arm Features:</i></p> <ul style="list-style-type: none"> • 14–32 lb. load capacity • 22" lift range • 360° rotation at base, 180° rotation at monitor mount • Monitor tower and keyboard platform rotate independently • Available in silver • Warranty: 5 years <p><i>Monitor Mount Features:</i></p> <ul style="list-style-type: none"> • Supports one 6.5–24.5 lb. monitor or two 1.25–10.25 lb. monitors with optional Dual Monitor Adaptor (max. 22" wide) • 9.5" independent monitor height adjustment <p><i>Standard Keyboard Platform Features:</i></p> <ul style="list-style-type: none"> • Features our Standard UB182-25 Keyboard Platform • In-Line mousing for right and left handed users • 3.75" independent keyboard platform adjustment 	SOL2-ST-CCG-S	53	\$999	\$1,279

Premium

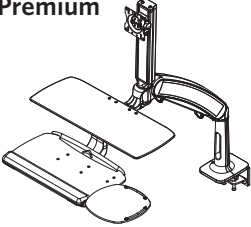
 <p>UB2100FT25 Keyboard Platform</p> <p><i>All the same Arm and Monitor Mount features as the Standard, plus:</i></p> <p><i>Premium Keyboard Platform Features:</i></p> <ul style="list-style-type: none"> • Features our Revo UB2100FT25 Keyboard Platform • Mouse platform tilts independently from keyboard platform • Mouse platform can be positioned in-line, mouse-forward and mouse-over in both right handed or left handed position • 3.75" independent keyboard platform adjustment 	SOL2-PR-CCG-S	54	\$1,099	\$1,407
---	---------------	----	---------	---------

Solace Single Sit-Stand

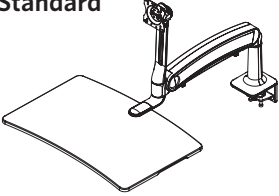
Standard	 <p><i>Arm Features:</i></p> <ul style="list-style-type: none"> • 13–31 lb. load capacity • 18.5" lift range • 360° rotation at base, 180° rotation at monitor mount • Monitor tower and keyboard platform rotate independently • Available in silver • Warranty: 5 years <p><i>Monitor Mount Features:</i></p> <ul style="list-style-type: none"> • Supports one 6–24 lb. monitor or two 1–10 lb. monitors with optional Dual Monitor Adaptor (max. 22" wide) • 6.3" independent monitor height adjustment <p><i>Platform Features:</i></p> <ul style="list-style-type: none"> • 28" W × 18" D Phenolic platform • Platform can be mounted above mounting plate for clean look or below to lay flush with worksurface 	SOL-SINGLE-CCG-S	29	\$799	\$1,023
-----------------	---	------------------	----	-------	---------

Solace Desktop

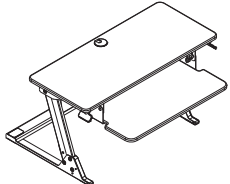
 <ul style="list-style-type: none"> • 35 lb. capacity • 13.8" lift range, 20" above desktop • Separate keyboard surface with 20° of tilt (+10°/-10°) • Available in black • Warranty: 2 years 	SOL-DT-B	40	\$599	\$766
---	----------	----	-------	-------

SPECIFICATIONS: SOLACE

Solace 2 Dimensions

Base reach & range (side)

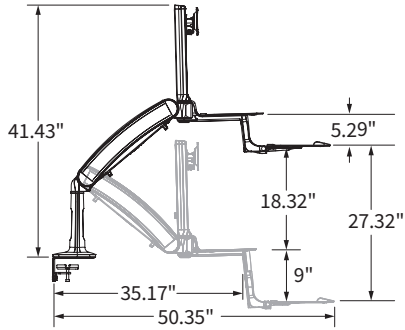

Pivot (top)

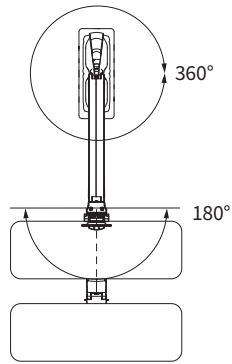

Stowed Depth

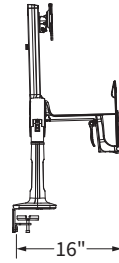

Base C-Clamp

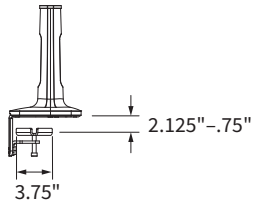

Grommet

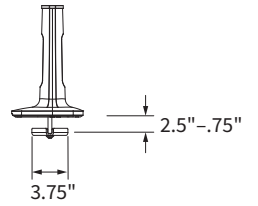

Keyboard platform tilt & range

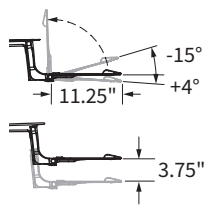

Standard Keyboard

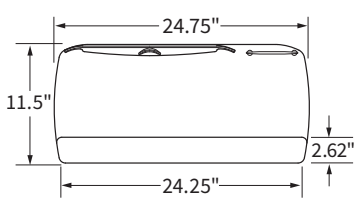

Premium Keyboard

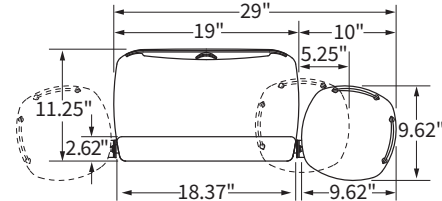

Secondary Surface

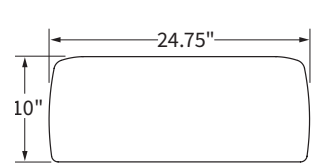

Monitor Mount tilt, rotate & swivel

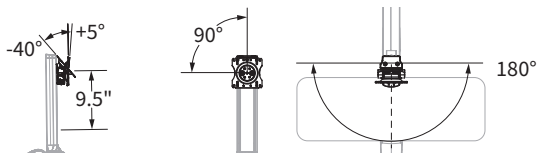

Dual Monitor Adaptor option

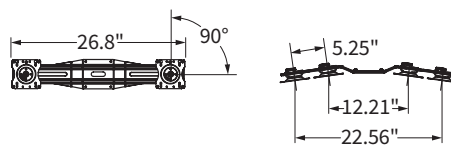

Solace Single Dimensions

Base reach & range (side)

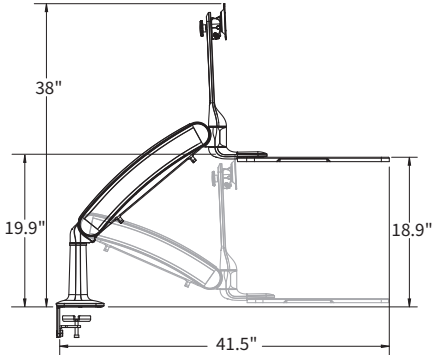

Pivot (top)

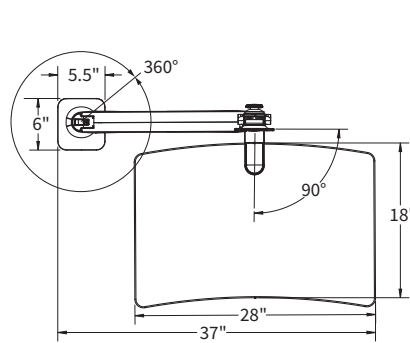

Stowed depth

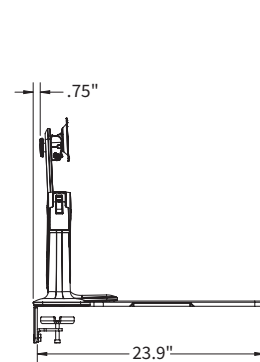

Solace Desktop Dimensions

Height & width

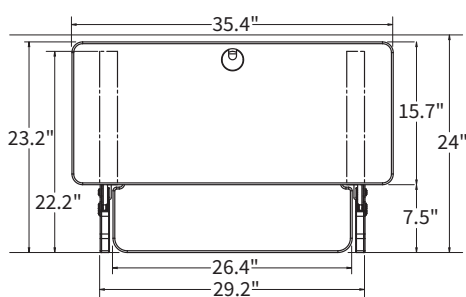

Depth & range

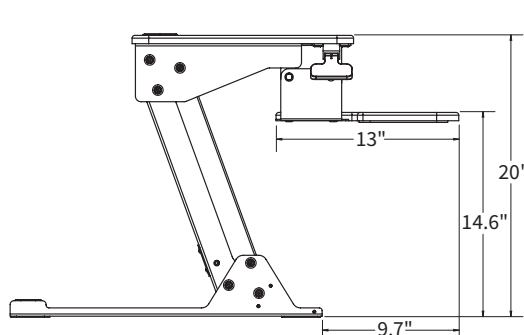

Stowed Depth

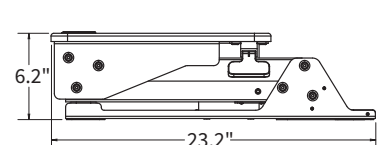

PRODUCT COMPARISON: SOLACE

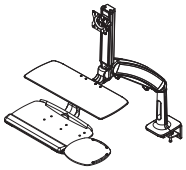
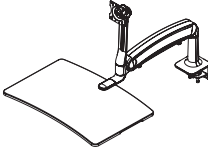
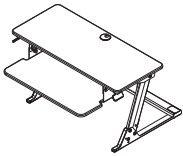
	Solace 2	Solace Single	Solace Desktop
			
US LIST PRICE	\$999/\$1,099	\$799	\$599
CANADA LIST PRICE	\$1,279/\$1,407	\$1,023	\$766
ADJUSTABILITY			
Load Capacity	14–32 lb.	13–31 lb.	35 lb.
Height Range	22"	18.5"	13.8" (20" above desktop)
Arm Pivot at Base/Monitor	360°/180°	360°/180°	n/a
Keyboard Platform Range	3.75"	n/a	14.6" (with worksurface)
Keyboard Platform Tilt	+4°/-15°	n/a	+10°/-10°
Monitor Height Range	9.5"	6.3"	n/a
Monitor Tilt Range/Swivel	+4°/-40°, 90°	+4°/-40°, 90°	n/a
Single Monitor Load Range	6.5–24.5 lb.	6–24 lb.	n/a
Optional Dual Monitor Load Range	1.25–10.25 lb. (each)	1–10 lb. (each)	n/a
Stowed Depth/Height	16" D	23.9" D	6.2" H
FEATURES			
Colors	Silver	Silver	Black
Integrated Monitor Mount	●	●	
Keyboard Platform	●	●	●
Secondary Worksurface	●		
Integrated Cable Management	●	●	●
ACCESSORIES			
Optional Dual Monitor Adaptor	●	●	n/a
Included Monitor Quick Release Adaptor	●	●	n/a
MOUNTING OPTIONS			
C-Clamp	●	●	n/a
Grommet	●	●	n/a
WARRANTY	5 years	5 years	2 years
AVAILABLE ON GSA	●	●	



Solace Desktop

SOLACE 2: SUPERIOR RANGE ENSURES ERGONOMIC COMFORT

Solace 2 promotes health and wellness by providing the core ergonomic benefits associated with height adjustable desks, monitor arms, and keyboard platforms. The all-in-one ergonomic workstation offers a quick & economical method to enhance user comfort as well as overall productivity. With its broad range of lift, rotation and tilt, Solace 2 has the flexibility to accommodate a wide variety of users and applications.

Solace 2 Arm:

The Solace 2 pneumatic strut allows the arm to effortlessly lift the keyboard and monitor(s) between the seated and standing positions. The industry leading keyboard platform height range makes Solace an ideal solution for multi-user environments.

- Designed to meet ANSI/BIFMA & HFES standards
- Keyboard Platform, Secondary Surface & Mount travel in unison, transitioning between seated and standing height effortlessly
- Stows down to just 16 " to quickly and easily access desktop workspace



Solace 2 Independent Keyboard Platforms:

A choice of two popular ergonomic keyboard platforms and the ability to independently raise or lower and tilt the keyboard platform to the ideal height is the key difference of Solace 2.

- Standard Keyboard Platform features UB182-25 Platform
- Premium Keyboard Platform features Revo UB2100FT25 Platform
- 3.75" of independent keyboard platform adjustment
- Folds up 90° for optimal storage



Solace 2 Independent Monitor Adjustment

To create a uniquely personalized configuration, Solace 2 incorporates the ability to fine-tune independent adjustments to your monitor. The counter balance technology creates a simple to use, knob free experience so the user can adjust monitor height with minimal effort.

- Supports one 6.5–24.5 lb. monitor
- 9.5" of independent height adjustment
- Standard VESA (75 mm & 100 mm)
- Quick Release Adaptor included for faster monitor installation

Optional Dual Monitor Adaptor:

- Supports two monitors 1.25–10.25 lb. each and up to 22" wide



SOLACE SINGLE: SIT-STAND BENEFITS AT A VALUE PRICE

The Solace Single will allow users to easily transform their existing desk to a sit-stand workstation. The Solace Single uses a gas assist counter balanced arm to raise and lower the single surface workstation through 18.5" of smooth acting height adjustment with industry leading stability. To maximize the use of the desk surface, the work surface can also be swung to the side when not in use. The Solace Single will complement every working environment and provide an ergonomic workstation at a value price.

Solace Single Arm:

- Height adjustment range of 18.5"
- A large adjustment range allows most users to experience the benefits of a sit-stand workstation
- Accommodates a wide range of technology requirements with balanced functionality



Standing position



Seated position

Solace Single Independent Monitor Adjustment

The Solace Single also incorporates the ability to fine-tune independent adjustments to your monitor. The user can adjust monitor pivot, tilt and height with minimal effort thanks to the independently pivoting monitor tower and monitor height adjustment knob.

- Supports one 6–24 lb. monitor
- 6.3" of independent height adjustment
- Standard VESA (75 mm & 100 mm)
- Quick Release Adaptor included for faster monitor installation

Optional Dual Monitor Adaptor:

- Supports two monitors 1–10 lb. each and up to 22" wide

SOLACE DESKTOP: EASY, STABLE AND DURABLE SIT STAND CONVERTER

Quickly and economically convert an existing desk to a smooth and effortless sit-stand workstation. Solace Desktop ships fully assembled making it the ideal retrofit solution. The compact footprint of the Solace Desktop, easily fits onto a 24" deep desk with room for personal equipment. The large primary work surface includes a grommet for cable management and can accommodate an added Workrite Monitor Arm or two 24" monitors. The wide lifting range and independent keyboard surface ensures that users can easily set Solace Desktop to their ideal ergonomic position. Solace Desktop is strong enough to support users technology requirements, yet light enough for simple installation and moving from desk-to-desk.

- Dual worksurface with independent keyboard surface
- 20° Keyboard tilt (+10°/-10°)
- 35 lb. lifting capacity
- 13.8" lifting range, 20" above desktop



Standing position



Seated position

Solace Accessories & Parts

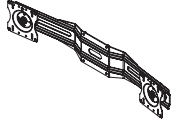
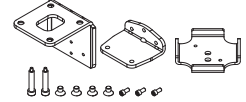
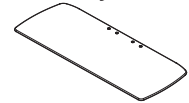
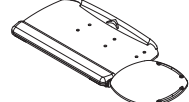
Dual Monitor Adaptor 	<ul style="list-style-type: none"> • Compatible with Solace 2 and Solace Single • Converts from single monitor to dual monitor use • Supports two monitors up to 22" actual width • Reduces maximum weight capacity of arm by 3 lb. <ul style="list-style-type: none"> • Solace 2: 1.25–10.25 lb. per monitor • Solace Single: 1–10 lb. per monitor • Includes additional Quick Release Adaptor 	SOL-ADPT-TWIN-S 3	\$99	\$127
C-Clamp & Hardware Kit 	<ul style="list-style-type: none"> • Compatible with Solace 2 and Solace Single 	SOL-HDWR1-CCG-B 5	\$99	\$127
Grommet Mount Hardware Kit 	<ul style="list-style-type: none"> • Compatible with Solace 2 and Solace Single 	SOL-HDWR2-BS-B 1	\$59	\$76
Secondary Surface 	<ul style="list-style-type: none"> • Compatible with Solace 2 	SOL-WS-1024-B 5	\$75	\$96
Standard Platform 	<ul style="list-style-type: none"> • Compatible with Solace 2 	SOL-AKP-ST-B 6	\$183	\$235
Premium Platform 	<ul style="list-style-type: none"> • Compatible with Solace 2 	SOL-AKP-REVO-B 6	\$227	\$291

ENVIRONMENTAL CONSIDERATIONS

Solace design was centered around green business practices with special focus on environmental sustainability. By incorporating recycled material in the manufacturing process, the Solace line contributes toward LEED credit ratings.

RECYCLED CONTENT & RECYCLABILITY

	Solace 2		Solace Single		Solace Desktop	
	Weight	Recycled Content	Weight	Recycled Content	Weight	Recycled Content
Total weight	25.73 lb.*	-	29.03 lb.	-	39.91 lb.	-
Recycled Content Total	13.6 lb.	53%	19.8 lb.	68%	28.9 lb.	73%
Post Industrial	9.1 lb.	35%	7.8 lb.	27%	11.1 lb.	28%
Post Consumer	4.55 lb.	18%	12 lb.	41%	17.81 lb.	45%
Recyclability of Product	25.5 lb.	99%	28.83 lb.	99%	39.7 lb.	99.48%

*Without Keyboard Platform.

LEED RECYCLABILITY CALCULATIONS

	Solace 2	Solace Single	Solace Desktop
Total Recycled Content: Post Consumer	18%	41%	45%
Total Recycled Content: Post Industrial	35%	27%	28%
Recyclability	99%	99%	99%
Recycled Content (LEED) Post Consumer Post Consumer + ½ Post Industrial	36%	55%	59%