

# Switch™

the **configurable,**  
**multi-monitor**  
mounting system



# Introducing Switch™. A highly configurable solution for multi-monitor applications.

Switch™ meets your current mounting requirements, but also easily adapts to meet your future requirements! You can convert your monitor configurations with little time or effort, often without even having to purchase additional components.



# One Switch™, many possibilities.

Workplace configurations are continually changing and evolving.  
That's why you need a monitor mounting system that can quickly adapt.

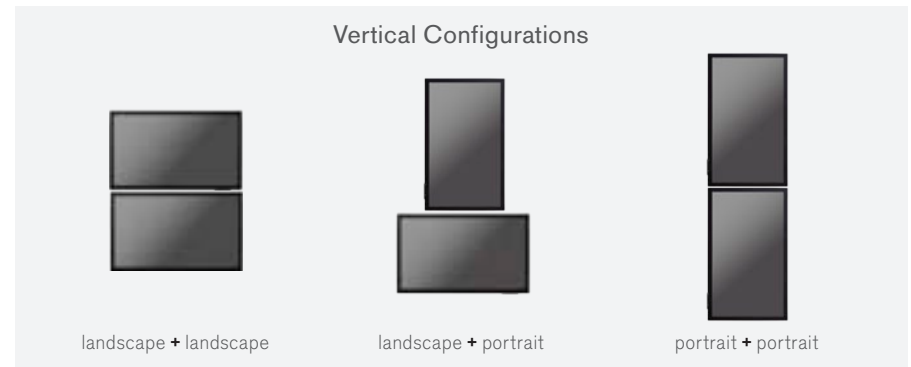
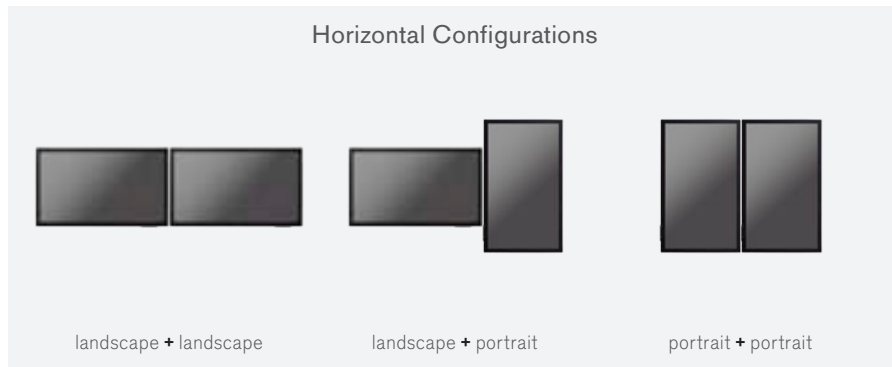
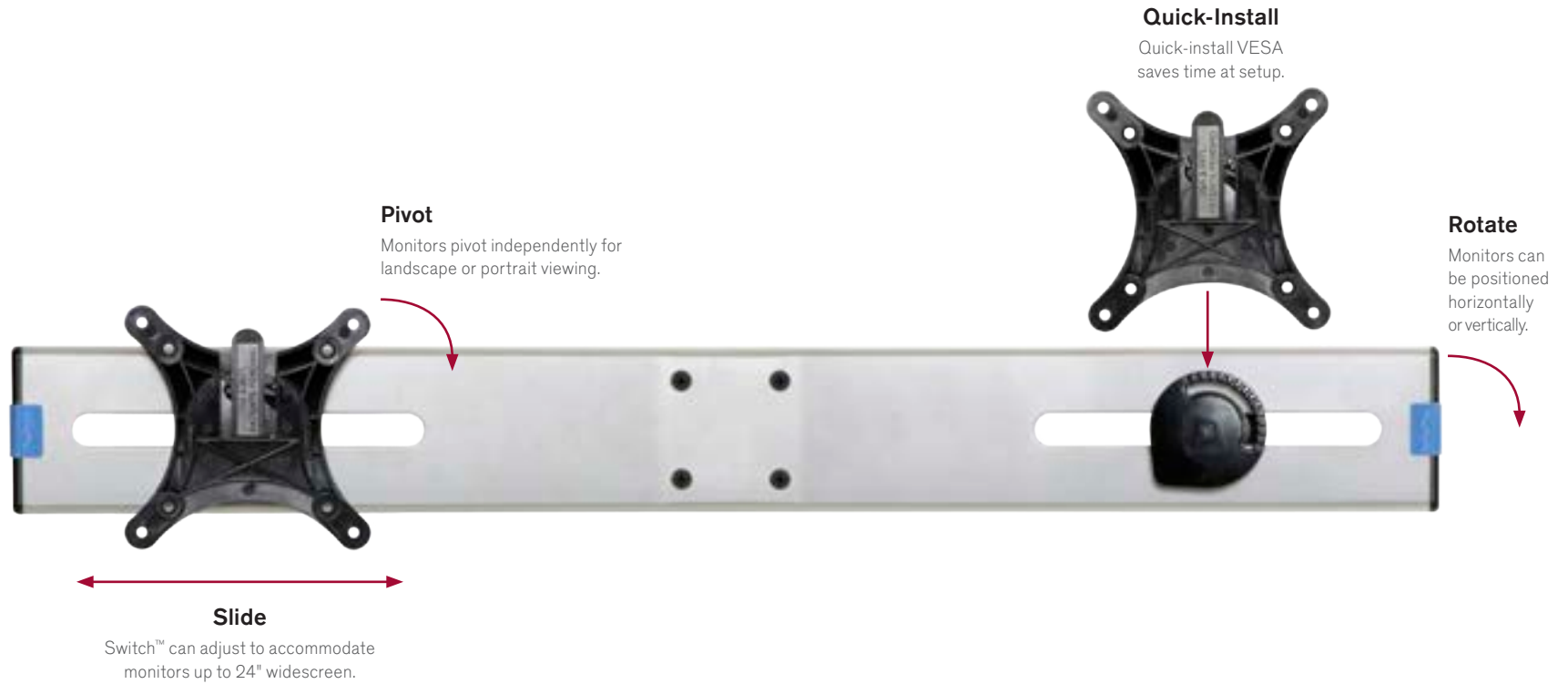

# It's all in the details.



**9136-Switch™**  
Ideal for tight work spaces.

**9112-Switch™**  
Offers greater reach and flexibility.



9112-Switch™ offers three articulation joints for greater versatility.



Unique cable management allows cables to be tucked under the forearm extensions.



Compatible with all Innovative mounts including FLEXmount™ and slatwall.

# Configurable solutions for a range of applications.

Switch™ multi-monitor mounting system is ideal in any of these environments:

- Financial trading
- Command & control
- A/V & multimedia
- Call centers





**9136-SWITCH-S-14-FM**

<b>Monitors</b>	2
<b>Monitor weight</b>	Up to 15 lbs (6.8 kg) per monitor
<b>Monitor size</b>	Up to 24" (61 cm) widescreen
<b>Monitor tilt</b>	Up to 180°
<b>Horizontal reach</b>	4.7" (11.9 cm) from center of pole
<b>Pole size</b>	14" (36 cm)
<b>Mounting options</b>	FLEXmount™, Slatwall
<b>VESA pattern</b>	75 & 100 mm

**9112-SWITCH-S-14-FM**

<b>Monitors</b>	2
<b>Monitor weight</b>	Up to 15 lbs (6.8 kg) per monitor
<b>Monitor size</b>	Up to 24" (61 cm) widescreen
<b>Monitor tilt</b>	Up to 180°
<b>Horizontal reach</b>	13.1" (33.3 cm) from center of pole
<b>Pole size</b>	14" (36 cm)
<b>Mounting options</b>	FLEXmount™, Slatwall
<b>VESA pattern</b>	75 & 100 mm

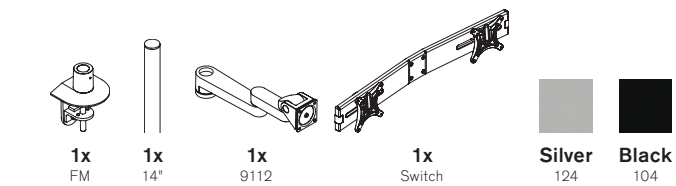
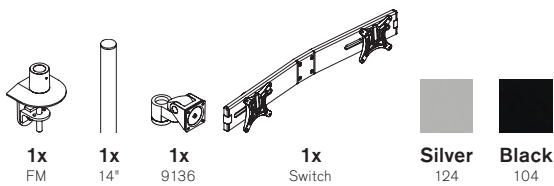



**9163-SWITCH-S-14-FM**

<b>Monitors</b>	3
<b>Monitor weight</b>	Up to 15 lbs (6.8 kg) per monitor
<b>Monitor size</b>	Up to 22" (61 cm) widescreen
<b>Monitor tilt</b>	Up to 180°
<b>Horizontal reach</b>	-
<b>Pole size</b>	14" (36 cm)
<b>Mounting options</b>	FLEXmount™, Slatwall
<b>VESA pattern</b>	75 & 100 mm

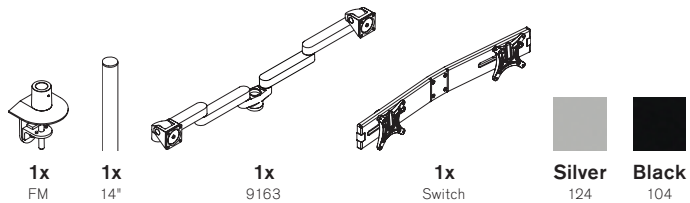

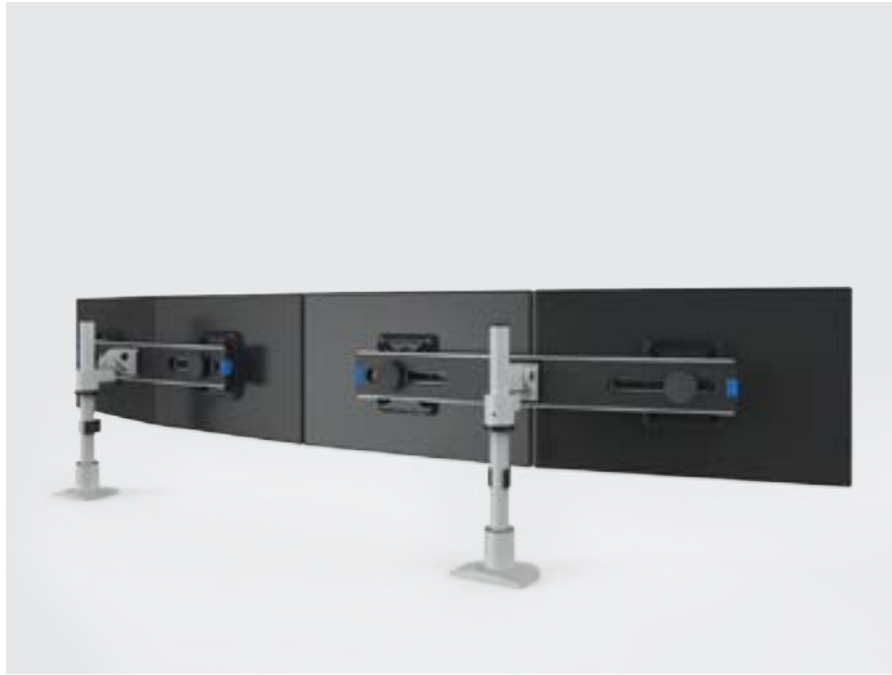

**9136-SWITCH-S-14-FM** (qty. 2)

<b>Monitors</b>	4
<b>Monitor weight</b>	Up to 15 lbs (6.8 kg) per monitor
<b>Monitor size</b>	Up to 24" (61 cm) widescreen
<b>Monitor tilt</b>	Up to 180°
<b>Horizontal reach</b>	4.7" (11.9 cm) from center of pole
<b>Pole size</b>	14" (36 cm)
<b>Mounting options</b>	FLEXmount™, Slatwall
<b>VESA pattern</b>	75 & 100 mm

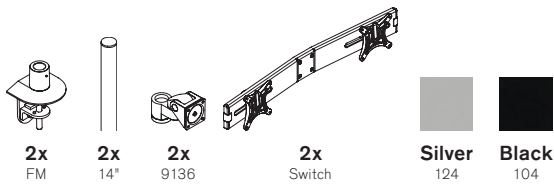

**9112-SWITCH-S-14-FM** (qty. 2)

<b>Monitors</b>	4
<b>Monitor weight</b>	Up to 15 lbs (6.8 kg) per monitor
<b>Monitor size</b>	Up to 24" (61 cm) widescreen
<b>Monitor tilt</b>	Up to 180°
<b>Horizontal reach</b>	13.1" (33.3 cm) from center of pole
<b>Pole size</b>	14" (36 cm)
<b>Mounting options</b>	FLEXmount™, Slatwall
<b>VESA pattern</b>	75 & 100 mm

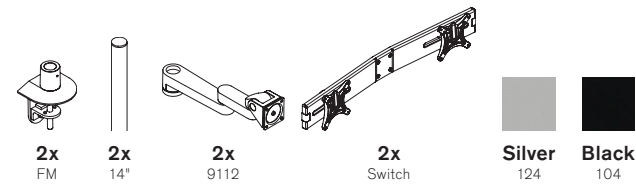





**9136-SWITCH-D-28-FM**

<b>Monitors</b>	4
<b>Monitor weight</b>	Up to 15 lbs (6.8 kg) per monitor
<b>Monitor size</b>	Up to 24" (61 cm) widescreen
<b>Monitor tilt</b>	Up to 180°
<b>Horizontal reach</b>	4.7" (11.9 cm) from center of pole
<b>Pole size</b>	28" (71 cm)
<b>Mounting options</b>	FLEXmount™, Slatwall
<b>VESA pattern</b>	75 & 100 mm

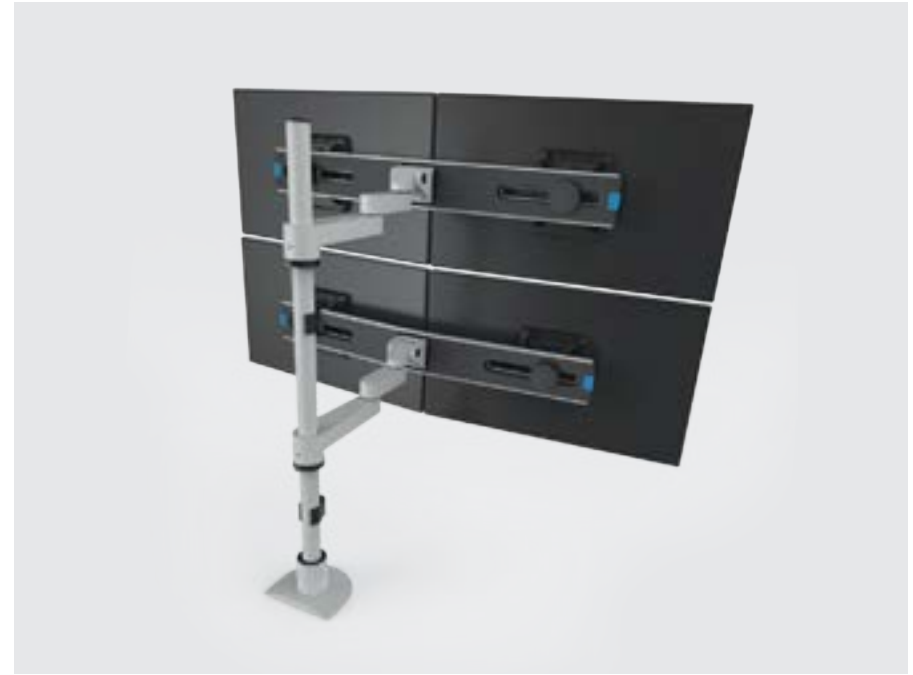
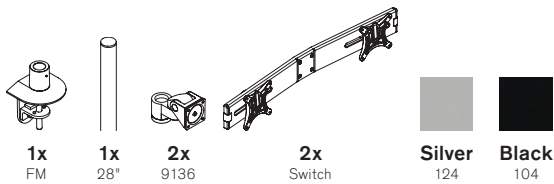

**9112-SWITCH-D-28-FM**

<b>Monitors</b>	4
<b>Monitor weight</b>	Up to 15 lbs (6.8 kg) per monitor
<b>Monitor size</b>	Up to 24" (61 cm) widescreen
<b>Monitor tilt</b>	Up to 180°
<b>Horizontal reach</b>	13.1" (33.3 cm) from center of pole
<b>Pole size</b>	28" (71 cm)
<b>Mounting options</b>	FLEXmount™, Slatwall
<b>VESA pattern</b>	75 & 100 mm

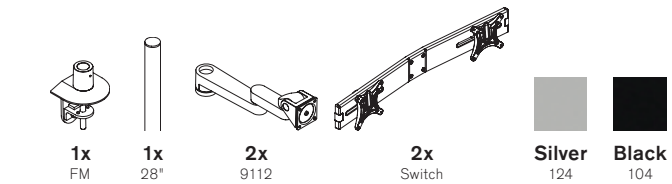



**9163-SWITCH-D-28-FM**

<b>Monitors</b>	6
<b>Monitor weight</b>	Up to 15 lbs (6.8 kg) per monitor
<b>Monitor size</b>	Up to 22" (61 cm) widescreen
<b>Monitor tilt</b>	Up to 180°
<b>Horizontal reach</b>	-
<b>Pole size</b>	28" (71 cm)
<b>Mounting options</b>	FLEXmount™, Slatwall
<b>VESA pattern</b>	75 & 100 mm

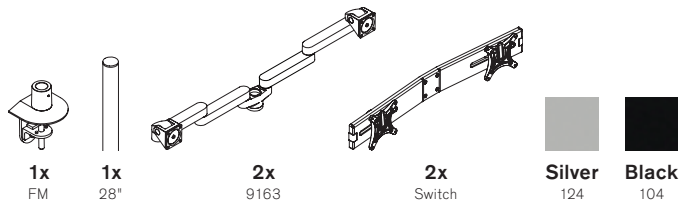



**9136-SWITCH-D-28-FM** (qty. 2)

<b>Monitors</b>	8
<b>Monitor weight</b>	Up to 15 lbs (6.8 kg) per monitor
<b>Monitor size</b>	Up to 24" (61 cm) widescreen
<b>Monitor tilt</b>	Up to 180°
<b>Horizontal reach</b>	4.7" (11.9 cm) from center of pole
<b>Pole size</b>	28" (71 cm)
<b>Mounting options</b>	FLEXmount™, Slatwall
<b>VESA pattern</b>	75 & 100 mm

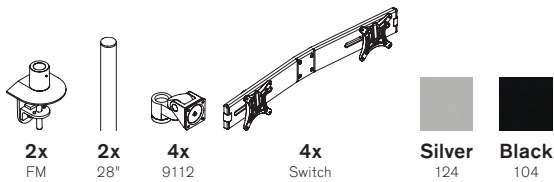

**9112-SWITCH-D-28-FM** (qty. 2)

<b>Monitors</b>	8
<b>Monitor weight</b>	Up to 15 lbs (6.8 kg) per monitor
<b>Monitor size</b>	Up to 24" (61 cm) widescreen
<b>Monitor tilt</b>	Up to 180°
<b>Horizontal reach</b>	13.1" (33.3 cm) from center of pole
<b>Pole size</b>	28" (71 cm)
<b>Mounting options</b>	FLEXmount™, Slatwall
<b>VESA pattern</b>	75 & 100 mm

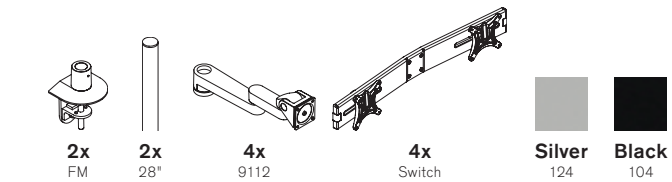

# Build a system that works for you.

All configurations shown in this brochure are created with a combination of the components shown here:

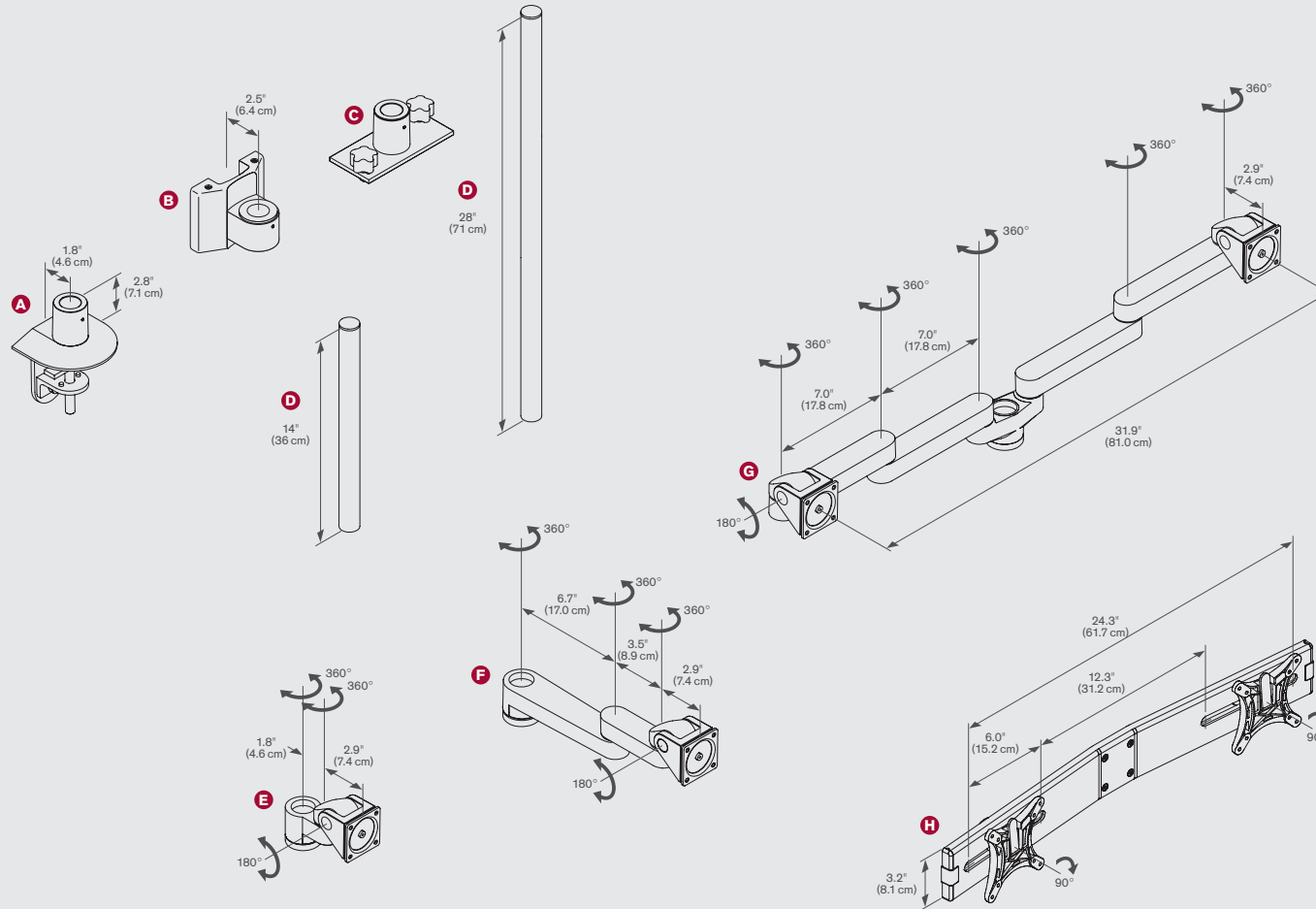

## MOUNTS

### A FLEXmount™

Six mounting solutions in one kit, including desktop, grommet clamp and thru-desk bolt.

### B Slatwall

Features secure attachment as well as fast installation. Cables can be routed between the mount and slatwall, helping to keep them neat and out of the way.

### C Slatrail

Installs securely to slatrail.

## POLES

### D 14" or 28"

Position arm at any height along pole. Requires an Innovative mount.

## ARMS

### E 9136 Short-Reach Pole Arm

Enables tilt and rotation of monitors. Supports a maximum of two monitors when combined with Switch™.

### F 9112 Long-Reach Pole Arm

Adds additional articulation joints for greater reach and flexibility. Supports a maximum of two monitors when combined with Switch™.

### G 9163 Dual Pole Arm

Supports a maximum of three monitors when combined with Switch™.

## SWITCH™

### H Switch™ Dual Monitor Bracket

Accommodates most monitors up to 24" widescreen. Allows horizontal/vertical positioning.

**Innovative Office Products**, established in 1986, is the leading manufacturer of ergonomic, space-saving arms and mounts for flat panel monitors, notebooks and tablet PCs. Innovative products have received design awards from such prominent sources as *red dot*, *Industrie Forum Hannover* (IF) and *Business Week* magazine.

Innovative specializes in custom manufacturing, choosing from a substantial database of mix-and-match parts to create custom solutions. Innovative's products have met the needs of such demanding users as the New York Stock Exchange, NASA and IBM.

HEADQUARTERS:

<b>Innovative Office Products</b>	<b>Innovative Europe ApS</b>	<b>Innovative Sul América Ltda.</b>
100 Kuebler Road	Center Boulevard 5	Rua Prefeito Osmar Cunha
Easton, PA 18040	Copenhagen, 2300	183 – Bloco B – SI 602
United States	Denmark	Florianópolis, Santa Catarina
tel 800.524.2744	tel +45 469.490.79	Brazil
fax 610.253.9521	fax +45 469.490.89	tel +55 (48) 3028.8460
www.LCDarms.com	www.LCDarms.eu	www.LCDarms.com.br

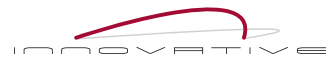

Products included in this brochure are protected by one or more of the following U.S. Patent Nos., and other United States and foreign patents applied for: 119,345, 119,346, 1,324,842, 2,470,525, 6,076,785, 6,273,383, 6,409,134, 6,478,274, 6,499,704, 6,505,988, 6,609,691, 6,19,606, 6,719,253, 6,726,167, 6,736,364, 6,783,105, 6,854,698, 6,915,994, 6,935,883, 6,955,328, 6,983,917, 6,986,489, 7,014,157, 7,017,874, 7,048,242, 7,059,574, 7,063,296, 7,066,433, 7,066,435, 7,389,965, 7,665,699, D435,852, D491,952, D492,893, D570,853, D575,293.  
© 2014 Innovative Office Products, LLC