

# Model 7500-Wing

Specifications



## FLEXMOUNT™ OPTIONS

Desk  
Clamp

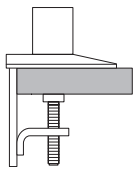

Thru-  
Desk

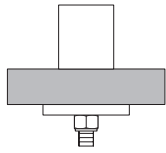

Wall  
Mount



Grommet  
Mount (hole greater than 2.5")

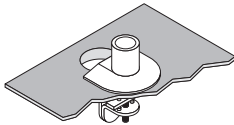

Side  
Mount

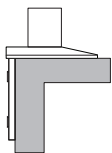

Reverse  
Wall  
Mount

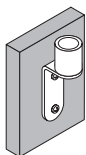

## WING BRACKET CAPABILITIES

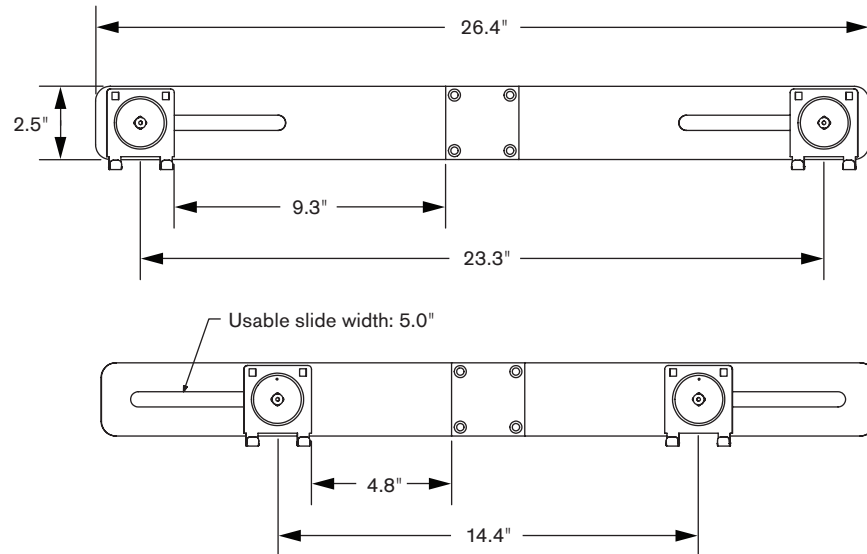

Max monitor width\*:..... 22" \*\* per monitor



\* Monitor width is measured from end to end of the monitor as shown at right:

\*\* This measurement is based on a monitor depth of 3.5".

The depth of the monitor will have a slight effect on the overall max dimension.

## ARM CAPABILITIES

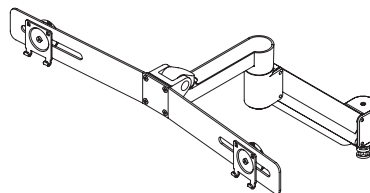

### Model 7500

Vertical range:..... +/- 9" from horizontal

Horizontal range:..... 27"

Rotation:..... 360 degrees at three joints

Monitor tilt:..... 200 degrees

Cable management:..... Cables are concealed in arm

Mounting options:..... FLEXmount™ – six different mounting options in one kit

Monitor weight/

model number:..... 9 - 21 lbs per monitor / 7500-Wing-1500  
3.5 - 13.5 lbs per monitor / 7500-Wing-1000

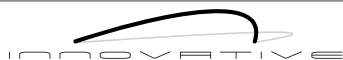

Phone: 800.524.2744 | Fax: 610.253.9521 | E-mail: sales@LCDarms.com | Web: www.LCDarms.com

This product is protected by one or more of the following U.S. Patent Nos., and other United States and foreign patents applied for: 6,076,785, 6,273,383, 6,409,134, 6,478,274, 6,499,704, 6,505,988, 6,609,691, 6,19,606, 6,719,253, 6,726,167, 6,736,364, 6,783,105, 6,854,698, 6,915,994, 6,935,883, 6,955,328, 6,983,917, 6,986,489, 7,014,157, 7,017,874, 7,048,242, 7,059,574, 7,063,296, 7,066,433, 7,066,435, D435,852, D491,952, D492,893.