

Model 8318

Extended Height *FLEX*mount™

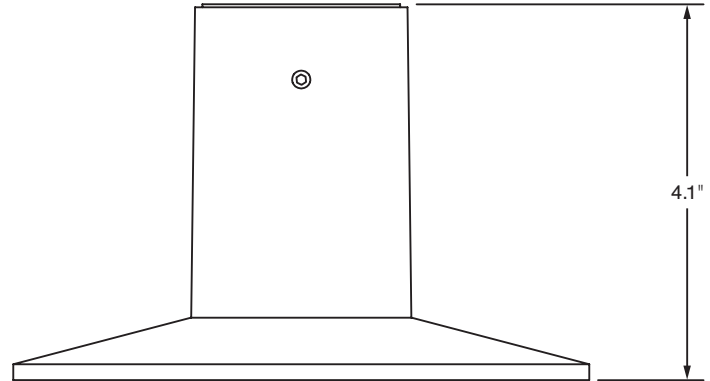

LIBERATE
YOUR
DESKTOP



FRONT VIEW

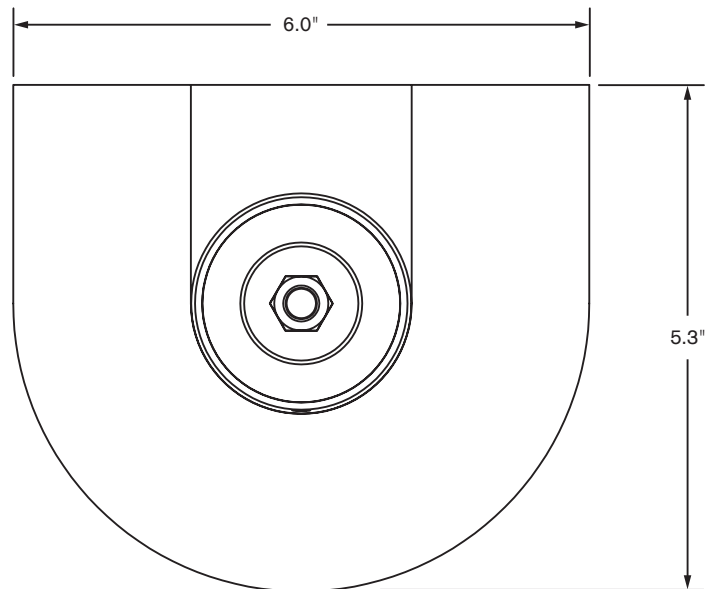

TOP VIEW

FLEXMOUNT™ MOUNTING OPTIONS:

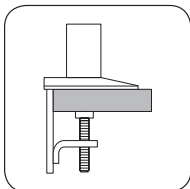

Desk Clamp
(3.5" thickness or less)

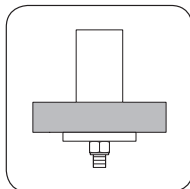

Thru-Desk

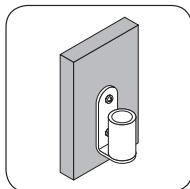

Wall

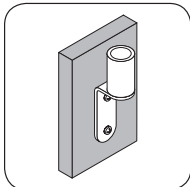

Reverse Wall

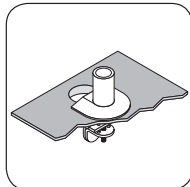

Grommet Hole
(2.5" or larger)

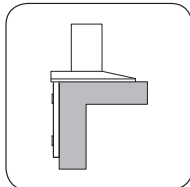

Side Bolt

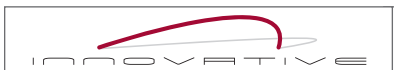

Phone: 800.524.2744 | Fax: 610.253.9521 | E-mail: sales@LCDarms.com | Web: www.LCDarms.com

This product is protected by one or more of the following U.S. Patent Nos. and other United States and foreign patents applied for: 119,345, 119,346, 1,324,842, 2,470,525, 6,076,785, 6,273,383, 6,409,134, 6,478,274, 6,499,704, 6,505,988, 6,609,691, 6,19,606, 6,719,263, 6,726,167, 6,736,364, 6,783,105, 6,854,698, 6,915,994, 6,935,883, 6,955,328, 6,983,917, 6,986,489, 7,014,157, 7,017,874, 7,048,242, 7,059,574, 7,063,296, 7,066,433, 7,066,435, 7,389,965, 7,665,699, D435,852, D491,952, D492,893, D570,853, D575,293.