

AnchorPad[®]

a Business Machine Security Company

Model 31177ARM | Laptop Security Stand

(Laptop, arm mounts and wall mounts are not included.)

Installation Instructions

Notes Before Beginning Installation:

1. To familiarize yourself with the entire installation process, please take a moment to read through all of the installation steps.
2. Disconnect all cables from the back of the laptop computer and clear the work surface around the wall or desk.
3. The Laptop Security Stand secures the laptop to a desk or arm mount. No variation of Laptop Security Stand will adhere directly to a wall.
4. When your laptop is installed in this product, the monitor remains open at all times.

Tools and Components included in your package:

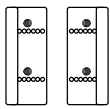

2-Wings

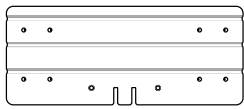

Ribbed Plate

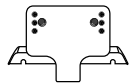

Paddle Bracket
w/Lock Block

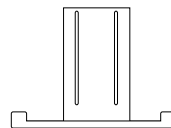

Slide Bracket

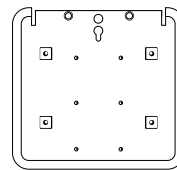

Base Plate

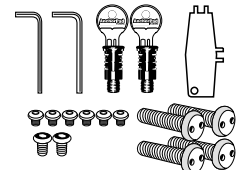

Hardware

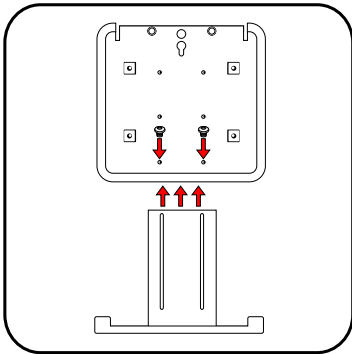

STEP 1:
Align Slide Bracket slots to the base plate. Screw Bracket loosely allowing bracket to slide easily.

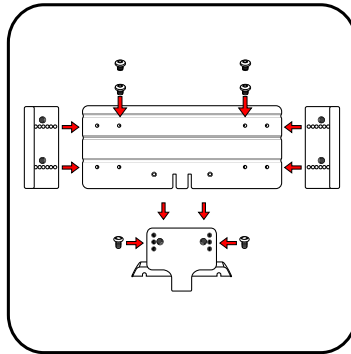

STEP 2:
Assemble the Back Plate and wings according to the size of your laptop. Slide Ribbed Plate onto Paddle Bracket and secure with screws.

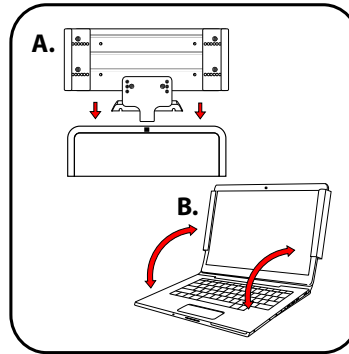

STEP 3:
(A) Slide assembled Back Plate onto laptop. (B) Once attached fold keyboard towards monitor.

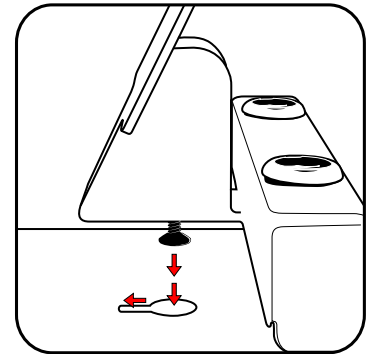

STEP 4:
Connect Back Plate to Base Plate by inserting the flat-head screw into the keyhole and pulling forward to lock.

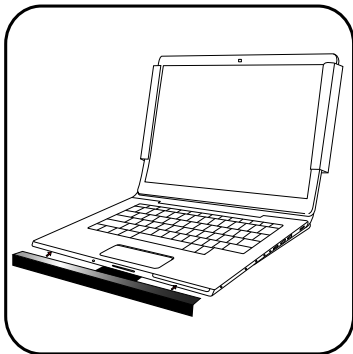

STEP 5:
Adjust Slide Bracket to fit snugly on keyboard. Mark position with pencil on bottom of slide. Remove back plate and tighten slide bracket on base plate at marked position.

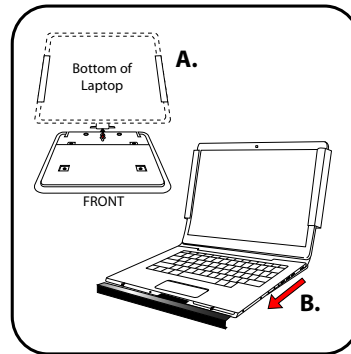

STEP 6:
(A) Re-insert flat head screw with computer in place. (B) Slide Back Plate and laptop forward to locked position and tighten flat-head screw from the bottom until snug.

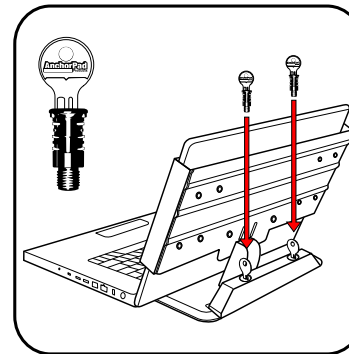

STEP 7:
Insert both locks into the Lock Block. Use keys to turn locks clockwise until fully threaded into pemnuts on the Base Plate. (**Do Not Overtighten**) Remove keys. Installation is now complete and ready to use.

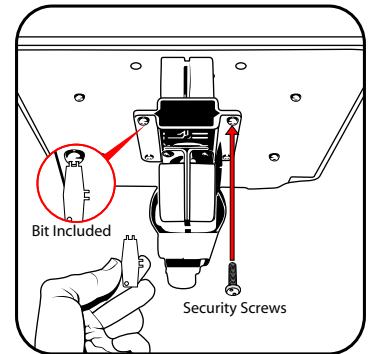

STEP 8:
To use with arm mount place assembled Laptop Security Stand on arm mount. Align the 4 holes on the base plate w/arm mount holes. Insert security screws from the bottom and tighten w/Bit provided.

Record key code for future reference and store keys in a safe place. Questions? Please call Technical Assistance 800.626.2467

Anchorpad a BMS Company | 520 West Central Avenue Brea, CA. 92821 | Toll-Free: 800.626.2467 Fax: 714.990.5409

www.anchorpad.com