

# STYLEVIEW® QUICK REFERENCE

ergotron®

## RANGE OF MOTION

Release Brake to move riser.

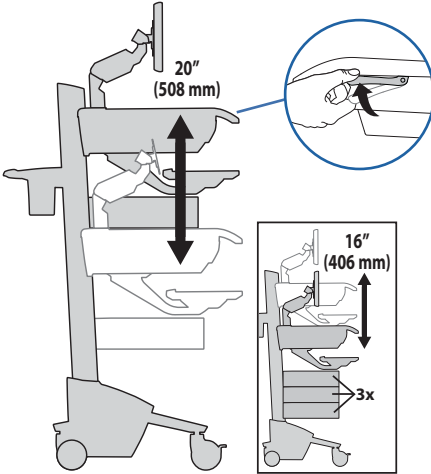

**CAUTION!** Completely release brake engagement before raising or lowering the cart. Raising or lowering the cart with the brake partially engaged may cause product damage.

[www.ergotron.com](http://www.ergotron.com)

USA: 1-800-888-8458

Europe: +31 (0)33-45 45 600

China: 400-120-3051

Japan: [japansupport@ergotron.com](mailto:japansupport@ergotron.com)

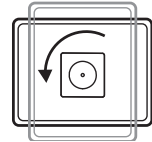
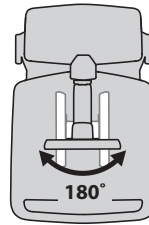
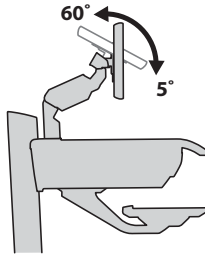
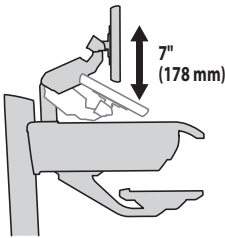
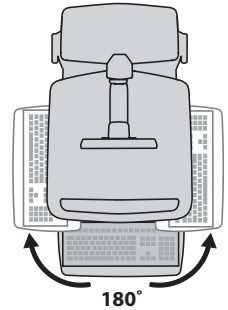
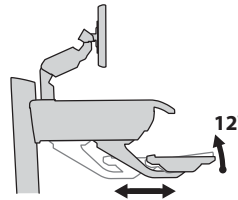

## ERGONOMICS

Working customize - to your size

- 1 Set top of monitor screen about one inch below eye level - Release brake and lift or lower riser as needed.
- 2 Tilt screen for comfortable viewing and to reduce eye and neck strain.
- 3 Pull keyboard tray forward and position mouse tray and mouse pouch on right or left, as needed.
- 4 Work with elbows bent at about 90° to minimize muscle strain.
- 5 If the riser moves up and down with difficulty, or if it drifts out of set position, consult the product manual for adjustment information.
- 6 Stay in charge!

Powered carts should be plugged into outlet as often as possible to keep battery charged and computer running.

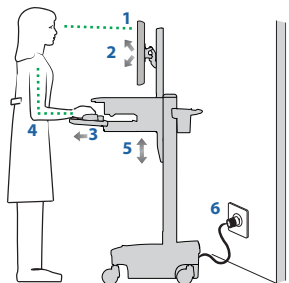

Moving stow - before you go

- 1 During normal movement, release brake and lower worksurface to lowest position for optimal stability and unobstructed view.
- 2 Tuck away open trays and return mouse, scanner and other accessories to their places. Clear worksurface
- 3 Unlock both front casters.
- 4 Push cart from rear with elbows bent at about 90° to maximize control and minimize muscle strain.
- 5 Don't run out!  
Before moving, make sure cord is unplugged from outlet and hooked to basket for safe travel. Remember, charge battery fully 100% every day!

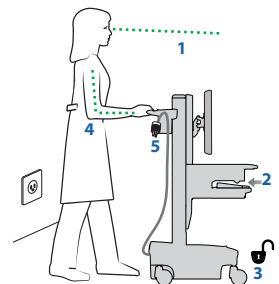

## KEYBOARD LIGHT

Your computer must be on for this light to function.

Keyboard Light will automatically turn off after 15 minutes if not manually turned off.

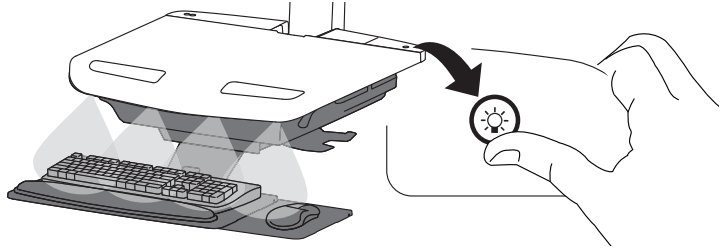

**Unlock Drawer (2 methods):** NOTE: All Drawers in row must be closed before a new row can be unlocked.

- Enter User PIN and press ENTER (only numbers for available drawer rows flash green), then press desired drawer row number\*.
- Key

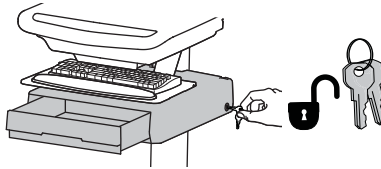
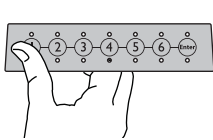

\*Drawer Row Numbers:

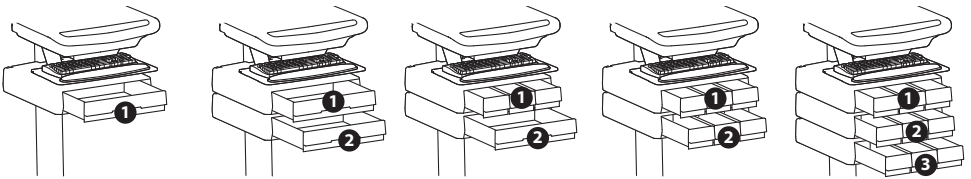

**Lock Drawer:**

- Wait 4 seconds for lock to engage automatically.

NOTE: Always ensure drawer is pushed in all the way and engaged with lock.



**CAUTION:** Close worksurface before opening drawers. Open only one drawer at a time. Do Not push cart when drawers or worksurface are open. Failure to follow these instructions may cause the cart to be unstable.