

P4263T

Installation Guide

Tilting Low-Profile Mount for Flat-Panels

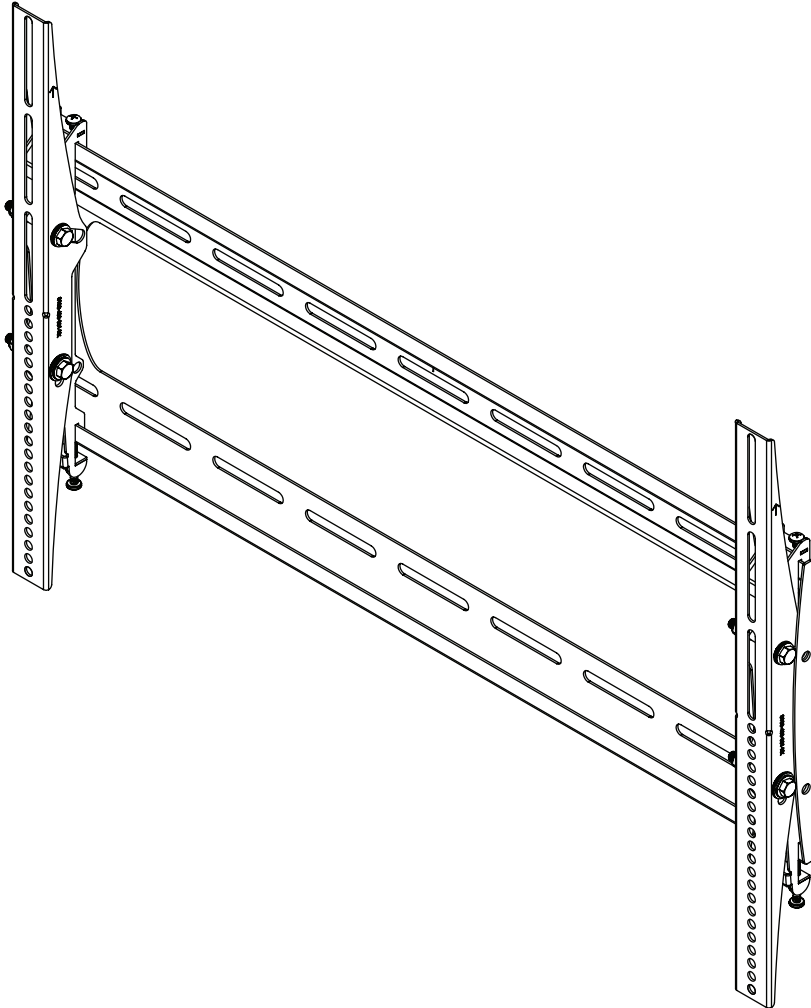











Weight Limit











Maximum Flat Panel Weight: **175 lb.**

THE WALL STRUCTURE MUST BE CAPABLE OF SUPPORTING AT LEAST FOUR TIMES THE WEIGHT OF THE FLAT PANEL. IF NOT, THE WALL STRUCTURE MUST BE REINFORCED.

Warning Statements

-  PRIOR TO THE INSTALLATION OF THIS PRODUCT, THE INSTALLATION INSTRUCTIONS MUST BE READ AND COMPLETELY UNDERSTOOD. KEEP THESE INSTALLATION INSTRUCTIONS IN AN EASILY ACCESSIBLE LOCATION FOR FUTURE REFERENCE.
-  PROPER INSTALLATION PROCEDURE BY A QUALIFIED SERVICE TECHNICIAN MUST BE FOLLOWED, AS OUTLINED IN THESE INSTALLATION INSTRUCTIONS. FAILURE TO DO SO COULD RESULT IN PROPERTY DAMAGE, SERIOUS PERSONAL INJURY, OR EVEN DEATH.
-  SAFETY MEASURES MUST BE PRACTICED AT ALL TIMES DURING THE ASSEMBLY OF THIS PRODUCT. USE PROPER SAFETY EQUIPMENT AND TOOLS FOR THE ASSEMBLY PROCEDURE TO PREVENT PERSONAL INJURY.
-  PREMIER MOUNTS DOES NOT WARRANT AGAINST DAMAGE CAUSED BY THE USE OF ANY PREMIER MOUNTS PRODUCT FOR PURPOSES OTHER THAN THOSE FOR WHICH IT WAS DESIGNED OR DAMAGE CAUSED BY UNAUTHORIZED ATTACHMENTS OR MODIFICATIONS, AND IS NOT RESPONSIBLE FOR ANY DAMAGES, CLAIMS, DEMANDS, SUITS, ACTIONS OR CAUSES OF ACTION OF WHATEVER KIND RESULTING FROM, ARISING OUT OF OR IN ANY MANNER RELATING TO ANY SUCH USE, ATTACHMENTS OR MODIFICATIONS.
-  At least two qualified people should perform the assembly procedure. Personal injury and/or property damage can result from dropping or mishandling the flat panel.
-  If mounting to wall studs or ceiling studs, make sure that the mounting screws are anchored into the center of the wall studs or ceiling studs. Use of an edge-to-edge stud finder is recommended.
-  It is recommended that a maximum of 5/8" plaster board be used when mounting to wooden studs.
-  Be aware of the mounting environment. If drilling and/or cutting into the mounting surface, always make sure that there are no electrical wires in wall. Cutting or drilling into an electrical line may cause serious personal injury.
-  Make sure there are no water or natural gas lines inside the wall where the mount is to be located. Cutting or drilling into a water or gas line may cause severe property damage or personal injury.
-  This product is intended for indoor use only. Use of this product outdoors could lead to product failure and/or serious personal injury.
-  Do not install near sources of high heat. Do not install on a structure that is prone to vibration, movement or chance of impact.

AVERTISSEMENT

-  AVANT L'INSTALLATION DE CE PRODUIT, LES CONSIGNES D'INSTALLATION DOIVENT ÊTRE LUES ET PLEINEMENT COMPRIS. CONSERVER CES CONSIGNES D'INSTALLATION DANS UN ENDROIT FACILEMENT ACCESSIBLE POUR RÉFÉRENCE FUTURE.
-  LA PROCÉDURE D'INSTALLATION CORRECTE PAR UN TECHNICIEN QUALIFIÉ DOIT ÊTRE OBSERVÉE, COMME DÉCRIT DANS CES CONSIGNES D'INSTALLATION. FAUTE DE QUOI DES DOMMAGES MATÉRIELS, BLESSURES GRAVES, VOIRE MÊME LA MORT PEUT SUBVENIR.
-  DES MESURES DE SÉCURITÉ DOIVENT ÊTRE PRATIQUÉES À TOUT MOMENT DURANT L'ASSEMBLAGE DE CE PRODUIT. UTILISER L'ÉQUIPEMENT ET OUTILS DE SÉCURITÉ APPROPRIÉ POUR LA PROCÉDURE D'ASSEMBLAGE AFIN D'ÉVITER DES BLESSURES.
-  LES SUPPORTS PREMIER MOUNTS NE GARANTISSENT PAS CONTRE LES DOMMAGES CAUSÉS PAR L'USAGE DU PRODUIT DE MONTAGE PREMIER MOUNTS À D'AUTRES FINS QUE CELLES POUR LESQUELLES IL A ÉTÉ CONÇU OU DES DOMMAGES CAUSÉS PAR DES ACCESSOIRES OU DES MODIFICATIONS NON AUTORISÉS, ET NOUS NE POUVONS PAS ÊTRE TENUS RESPONSABLES DES DOMMAGES, PLAINTES, RÉCLAMATIONS, POURSUITES, ACTIONS OU CAUSES D'ACTION DE N'IMPORTE QUELLE MANIÈRE RÉSULTANT DE, DÉCOULANT DE OU TOUCHANT DE N'IMPORTE QUELLE MANIÈRE UN TEL USAGE, ACCESSOIRE OU MODIFICATION
-  Au moins deux personnes qualifiées devraient exécuter la procédure d'assemblage. Il pourrait subvenir des blessures et/ou des dommages matériels dû à la chute ou à la manipulation incorrecte de l'écran plat.
-  Si le montage s'effectue sur des rivets, assurez-vous que les vis de montage sont ancrées au centre des rivets. L'usage d'un détecteur de rivet bord-à-bord est recommandé.
-  Il est recommandé qu'un maximum de plaque-plâtre de 5/8" soit utilisé lors d'un montage sur des rivets à bois.
-  Familiarisez-vous avec l'environnement de montage. Si un perçage et/ou une coupe est opéré sur la surface de montage, assurez-vous toujours qu'il n'y a pas de fils électriques dans le mur. Couper/percer dans une installation électrique peut causer des blessures graves.
-  S'assurer qu'il n'y a pas de canalisation d'eau ou de gaz naturel dans le mur où le montage doit être localisé. Une coupe ou un perçage dans une canalisation d'eau ou de gaz naturel peut causer des dommages matériels ou des blessures graves.
-  Ce produit n'est destiné qu'à être utilisé à l'intérieur. L'utilisation de ce produit à l'extérieur pourrait entraîner des défauts matériels et/ou des blessures graves.
-  Ne pas installer près de sources de forte chaleur. Ne pas installer sur une structure soumise aux vibrations, aux mouvements ou aux chocs.

P4263T Installation Guide

Included Components

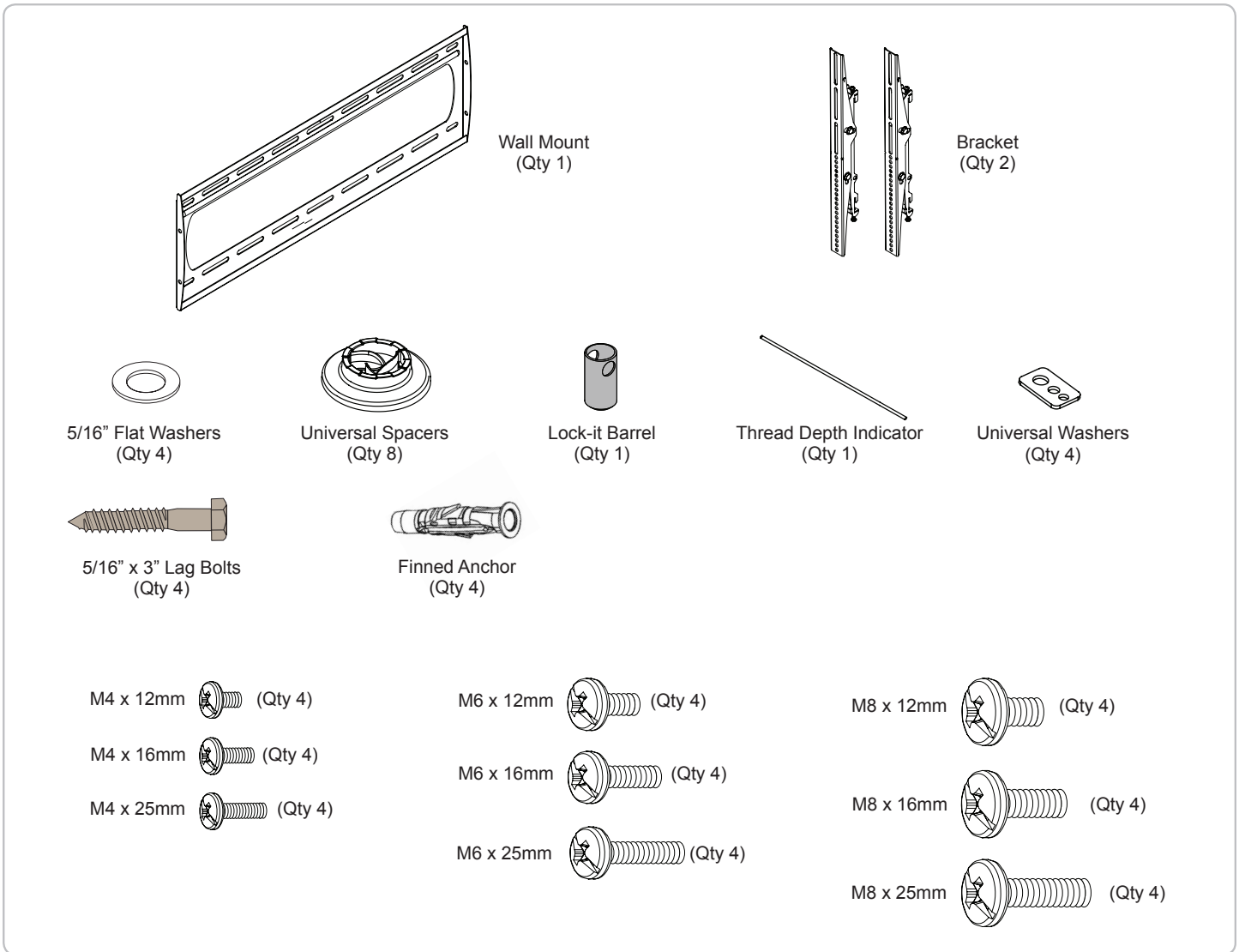

Required for installation

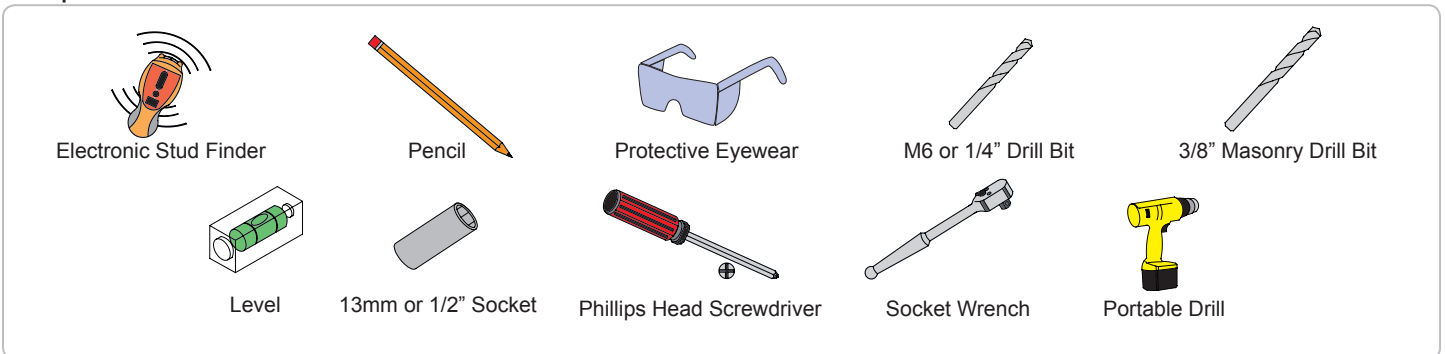

P4263T

Installation Guide

Introduction



Directional Mounting Arrow

The Directional Mounting Arrow stamped into the top of the P4263T wall mount indicates which edge is the top.

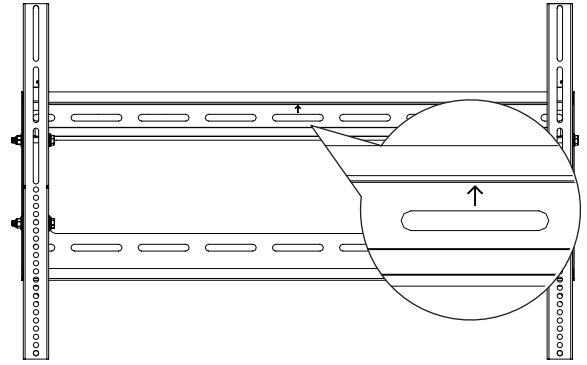

Wood Stud Installation

1



Minimum of 2 by 4 wood stud to be used



Minimum de 2 par 4 bois goujon pour être utilisé



You must secure the wall plate to two (2) wall studs with a minimum of four (4) lag bolts (2 lag bolts for each stud found).



Vous devez assembler la sablière sur deux (2) rivets de mur avec un minimum de quatre (4) tirefonds (2 tirefonds pour chaque rivet trouvé).

- 1) Use a stud finder to determine the center of wall studs in the vicinity of the wall plate.
- 2) Use a pencil to mark the center of each of the wall studs.

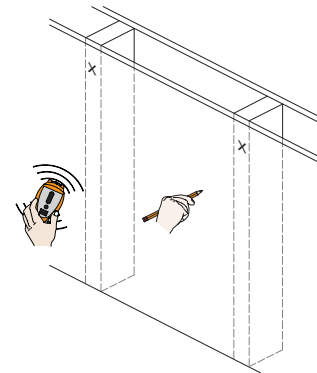

2

- 1) Place the wall plate against the wall in the desired viewing location.
- 2) Use a pencil to mark the upper right mounting location along the center of the wall stud.

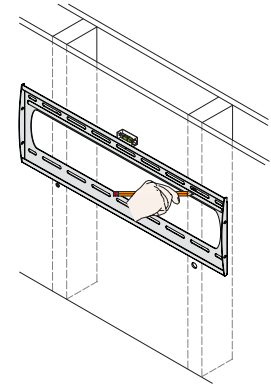

3

Drill a "pilot hole" in the center of the upper right mark using a 1/4" drill bit and power drill.



Only use a 1/4" drill bit when drilling the pilot holes.



N'utiliser qu'un foret de 1/4" lors du forage de guidage.

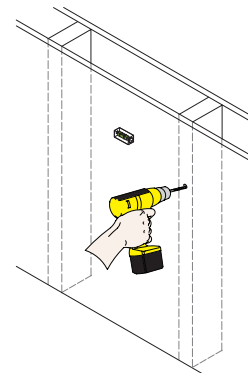

4

- 1) Place the wall plate against the wall and align it with the pilot hole.
- 2) Insert one (1) 5/16" x 3" lag bolt and one (1) 5/16" washer into the upper right mounting hole and tighten using a socket wrench and 1/2" socket.



Do not overtighten the lag bolt.



Éviter de trop serrer le tirefond.

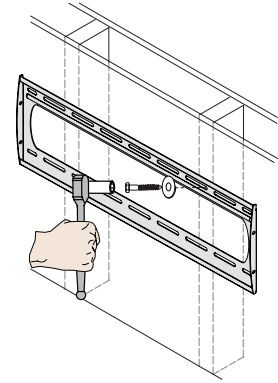

5

- 1) Level the wall plate.
- 2) Use a pencil to mark the remaining three (3) mounting locations along the center of each wall stud.

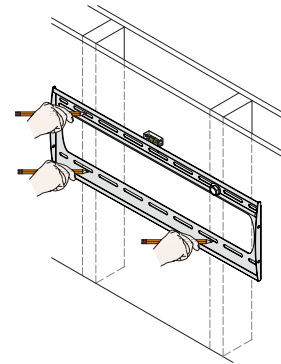

6



Two people are recommended for this step; one person to level the wall plate and another person to drill the pilot holes.



Il est recommandé deux personnes pour cette étape : une personne pour niveler la sablière et une autre personne pour percer le forage de guidage.

Drill a "pilot hole" in the center of each of the marks with a power drill and a 1/4" drill bit.



Only use 1/4" drill bit when drilling the pilot holes.



N'utiliser qu'un foret de 1/4" lors du forage de guidage.

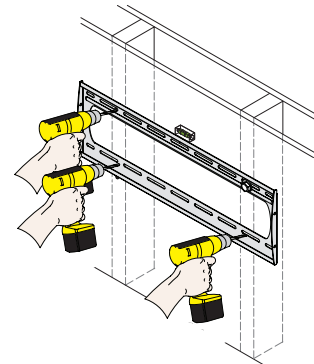

7

- 1) Insert one (1) 5/16" x 3" lag bolt and one (1) 5/16" washer into each pilot hole.
- 2) Tighten all lag bolts using a socket wrench and 1/2" socket.



Do not overtighten the lag bolts when attaching the mount to the wall. Improper installation may result in personal injury or property damage.



Éviter de trop serrer les tirefonds lors de la fixation du support au mur. Une installation incorrecte peut entraîner des blessures ou des dommages matériels.

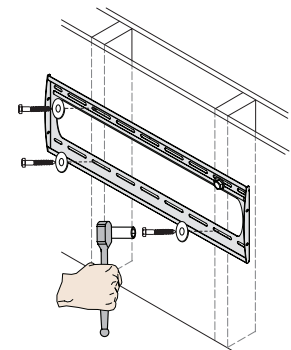

P4263T

Installation Guide

Concrete Installation

8



Two people are recommended for this step: one person to level the wall plate and another person to mark the mounting locations.



Il est recommandé deux personnes pour cette étape : une personne pour niveler la sablière et une autre personne pour marquer les emplacements de montage.

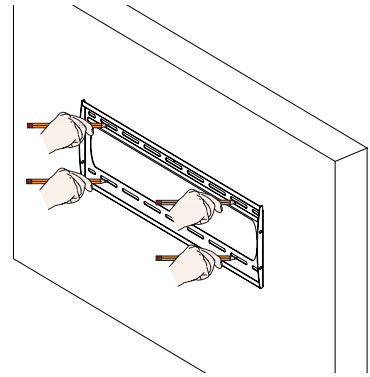

9

Drill four (4) pilot holes of each mark using a drill and 3/8" masonry drill bit. Drill 3 inches deep.



Only use a 3/8" masonry drill bit when drilling pilot holes.



N'utiliser qu'un foret de 3/8" lors du forage de guidage.

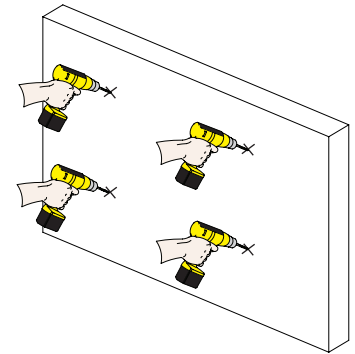

10

Insert the Finned Anchors into each pilot hole.

Lightly tap each Finned Anchors into place with a hammer.

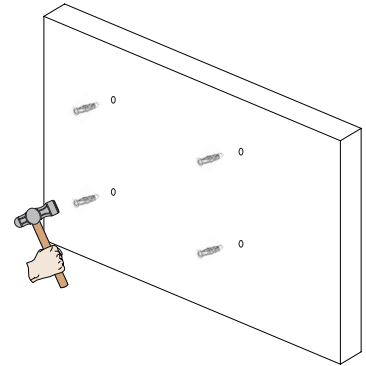

11

- 1) Insert one (1) 5/16" x 3" Lag Bolt and one (1) 5/16" washer into each pilot hole.
- 2) Tighten all lag bolts using a socket wrench and 1/2" socket.



Do not overtighten the lag bolts when attaching the mount to the wall. Improper installation may result in personal injury or property damage.



Éviter de trop serrer les tirefonds lors de la fixation du support au mur. Une installation incorrecte peut entraîner des blessures ou des dommages matériels.

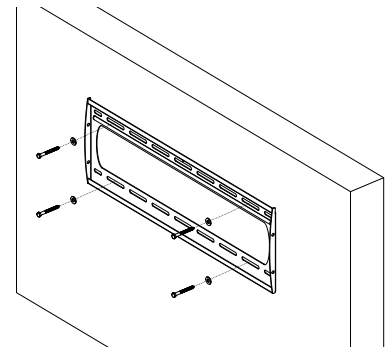

Selecting the Mounting Hardware

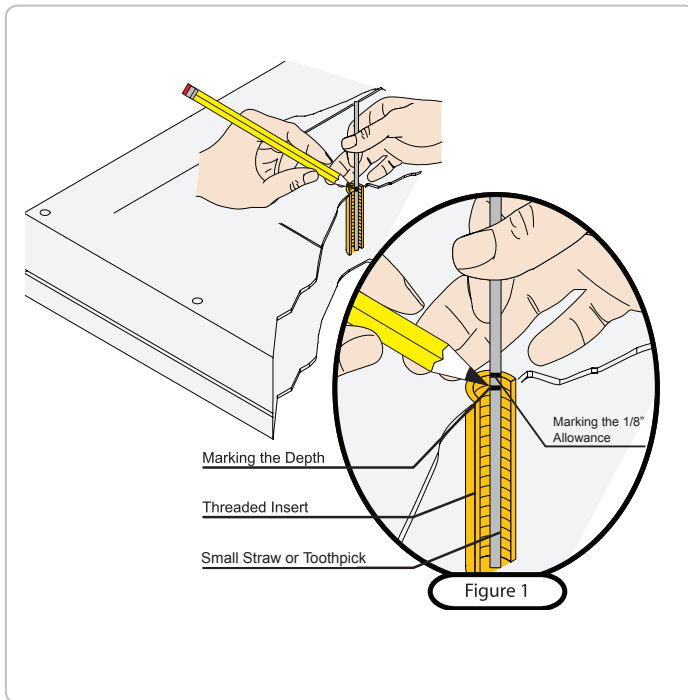

- 1) Insert a small straw or toothpick into the threaded inserts found on the back of the flat-panel.
- 2) Use a pencil to mark the depth of the threaded insert on the small straw or toothpick.
- 3) Mark the straw or toothpick 1/8" above the depth of the threaded insert, as shown in Figure 1.
- 4) Insert the small straw or toothpick into the remaining threaded inserts to compare and verify their depth using the straw or toothpick's 1/8" allowance mark.
- 5) Locate the correct diameter screw for the threaded insert.



If the screw you selected is longer than the 1/8" allowance mark on the small straw or toothpick, as shown in Figure 2 and Figure 3, do not use this screw. The screw length must not bypass the mark.



Si la vis que vous sélectionnez est plus longue que la marque du jeu maximal de 1/8" sur le pailon ou le cure-dents, comme illustré sur le schéma 2 et le schéma 3, veuillez ne pas utiliser cette vis. La longueur de la vis doit dévier la marque.

- 6) Test each size of the screws provided.
The correct screws should thread easily into the mounting point and not pull out when tension is applied.

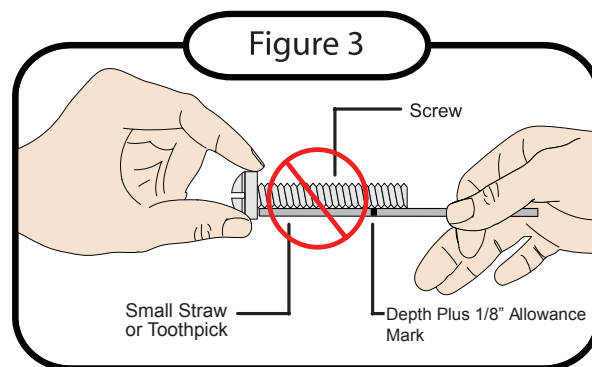
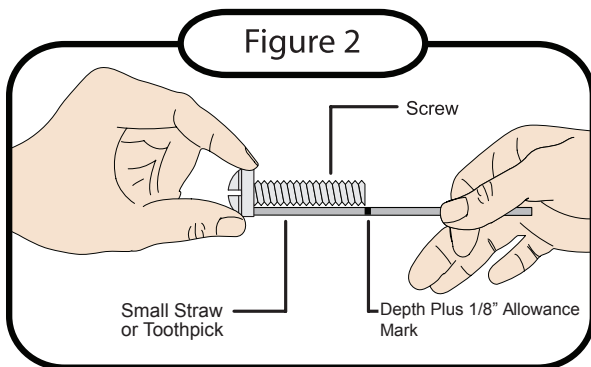



P4263T

Installation Guide

Universal Washer Installation

Premier Mounts' Universal Washers are designed to accommodate the various M4, M5, M6 and M8 hole sizes required by flat panels.

 Do not place excessive pressure on the back of the flat panel, as this may damage your flat panel.

 The Universal Washer must be installed between the head of the mounting screw and the mounting bracket as shown.

 Does your flat panel have:

- Recessed mount points?
- Uneven mount points?
- A curved back?
- Any obstruction near the mount point?

If **Yes**, you must install Universal Spacers. Remove the mounting brackets, Universal Washers, and mounting screws from the back of the flat panel. Proceed to the "Universal Spacer Installation" section.

If **No**, skip to the "Attaching the Mounting Bracket to the Flat Panel" section.

Universal Spacer Installation

Premier Mounts' Universal Spacers allow you to attach the mounting bracket to flat panels which have recessed or uneven mount points. Each Universal Spacer adds 1/4" to the distance between the mounting bracket and your flat panel.

 The Universal Spacers must be stacked and oriented as shown.

 La rondelle tous usages doit être installée entre le chapeau de la vis de fixation et le support de montage comme illustré.

 The Universal Spacers must only be installed between the mounting bracket and your flat panel.

 Les entretoises tous usages ne doivent être installées qu'entre le support de montage et votre écran plat.

The Universal Spacers will fit M4, M5, M6 and M8 screw sizes.

Proceed to the "Attaching the Mounting Bracket to the Flat Panel" section.

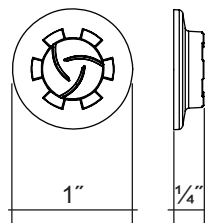

 Éviter de placer une pression excessive à l'arrière de l'écran plat, car cela risque d'endommager votre écran plat.

 La rondelle tous usages doit être installée entre le chapeau de la vis de fixation et le support de montage comme illustré.



Votre écran plat est-il muni de :

- Points de montage encastrés ?
- Points de montage inégaux ?
- Un plan arrière arrondi ?
- Une obstruction à l'emplacement du point d'assemblage ?

Si **Oui**, vous devez installer des entretoises universelles. Enlever les supports de montage, les rondelles universelles, et les vis de montage de l'arrière de l'écran plat. Passer à la section « **Installation d'entretoises universelles** ».

Si **Non**, aller à la section « **Fixation du support de montage sur l'écran plat** ».

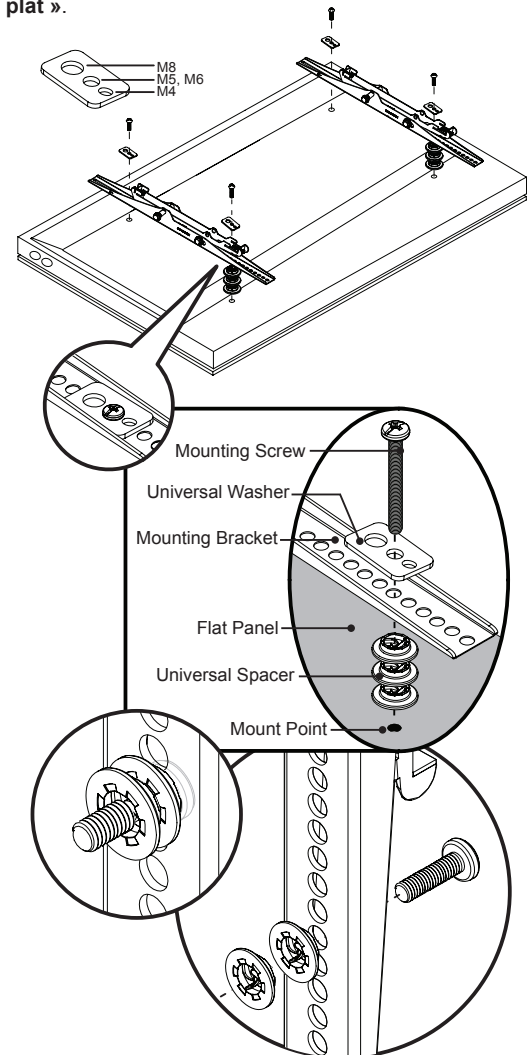



Attaching the Mounting Bracket to the Flat Panel

This section presumes that you have read and understood these sections:

- Selecting the Proper Mounting Hardware
- Universal Washer Installation
- Universal Spacer Installation

- 1) Place your flat panel screen-side down on a soft, flat surface.
- 2) Identify the number and location of the thread inserts on the back of your flat panel.
- 3) Align the holes on each mounting bracket with the thread inserts on the back of your flat panel.
- 4) Secure each mounting bracket to your flat panel by inserting a minimum of two (2) screws per bracket.

 Do not overtighten the mounting hardware.

 Éviter de trop serrer le dispositif de montage.

Proceed to the "Attaching the Flat Panel to the Wall Plate" section.

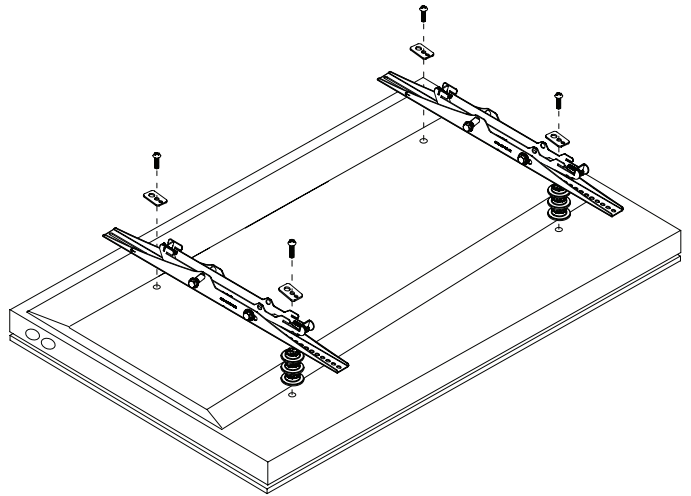

Lock-it™ Security Barrel Installation (Optional)



Optional security configurations include:

- PCB-CSL1 (sold separately)
- Padlock (Combination or Keyed; commercially available)

- 1) Remove the locking screw from the mounting bracket.
- 2) Place the locking screw into and through the security barrel (see illustration below).
- 3) Re-insert the locking screw and security barrel into the mounting bracket.
- 4) Tighten the locking screw and security barrel until seated in the mounting tab.

 Do not thread the locking screw any further once it is even with the mounting tab (see illustration to the right). Threading the locking screw any further will prevent you from safely attaching the flat panel to the wall plate.

 Éviter d'enfiler davantage la vis de réglage une fois qu'elle parvient au niveau de la patte de fixation (voir illustration à droite). Le filetage excessif de la vis de réglage au-delà de ce point gênera le fixage correct de l'écran plat sur la sablière.

 Do not overtighten the locking screw.

 Éviter de trop serrer la vis de blocage.

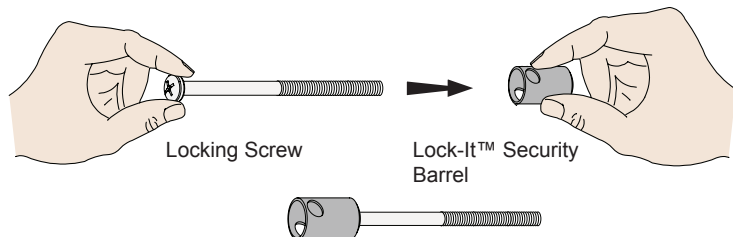
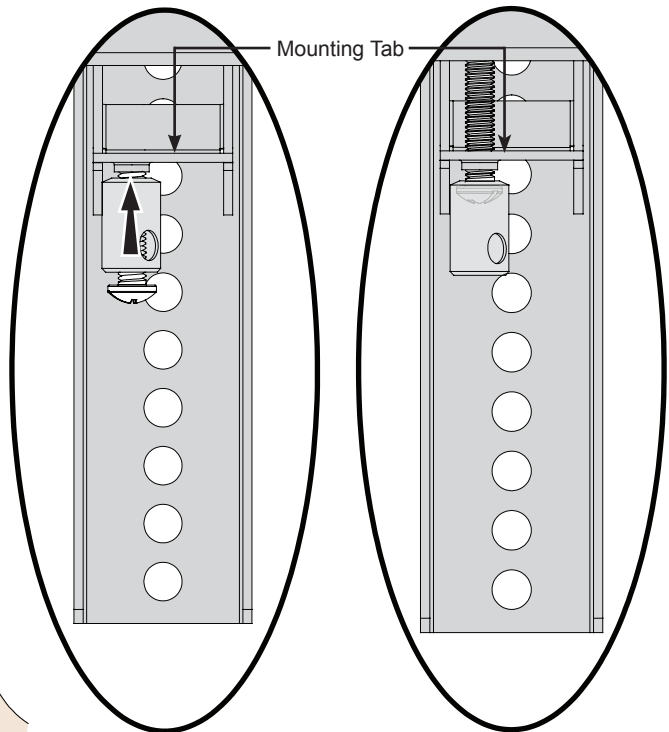

P4263T

Installation Guide

Attaching the Flat Panel to the Wall Plate



This section requires two people.



Cette section exige deux personnes.



Do not release your flat panel until you are certain that top and bottom hooks of both mounting brackets are securely seated on the upper and lower mounting rails of the wall panel.



Éviter de relâcher votre écran plat jusqu'à ce que vous vous assuriez que les crochets de haut et de bas de tous les deux supports de montage sont bien posés sur les rails de montage hauts et bas de la sablière.

- 1) Raise the flat panel past the top and bottom mounting rails on the wall panel.
- 2) Slide the flat panel down slowly, keeping it close to the wall.
- 3) Engage the top and bottom mounting brackets to the rails of the wall plate.

Proceed to the "Mounting Bracket Adjustments" section.

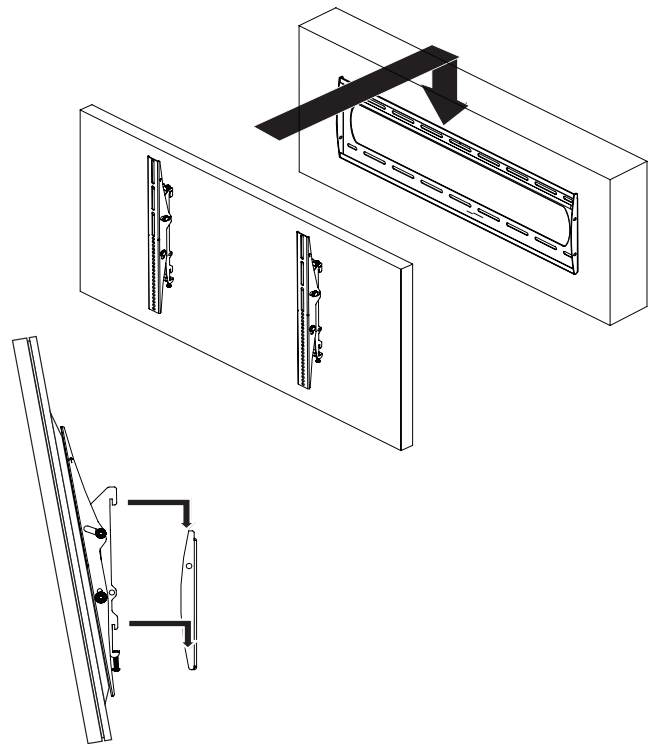

Mounting Bracket Adjustment

Leveling Screw Adjustment

If your flat panel is tilted too far to one side, the leveling screws will allow you to compensate for this tilt by simply adjusting the screws with a screwdriver.

- 1) Loosen both locking screws.
- 2) Adjust the tilt of your flat panel.
- 3) Tighten both locking screws.



Caution!

It is possible to dislodge your flat panel while you level your flat panel. Use extreme caution until you tighten the locking screws.



Attention !

C'est possible de retirer votre écran plat pendant son réglage. User d'une extrême prudence jusqu'au moment du serrage des vis de blocage.

Locking Screw Adjustment

After you have finished leveling your flat panel, be sure to tighten the two (2) M6 x 35mm locking screws.



Do not overtighten the locking screws.



Éviter de trop serrer les vis de blocage.

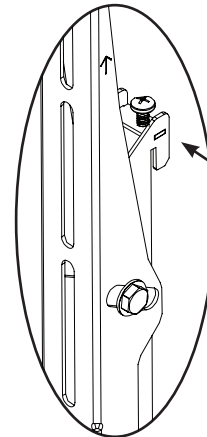

M6 x 30mm
Leveling Screw
(1 per Bracket)

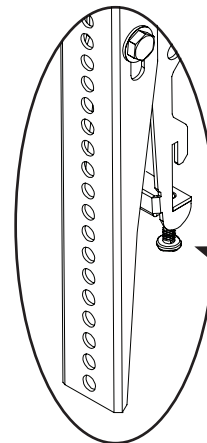

M6 x 35mm
Locking Screw
(1 per Bracket)

Tilt Adjustment

Adjusting the Flat Panel Friction Tilt Angel

- 1) Place one hand at the center top edge of the flat panel.
- 2) Place the other hand on the center bottom edge of the flat panel.
- 3) Using the upper hand, gently pull the top of the flat panel towards you while the lower hand gently pushes the bottom of the flat panel away from you.

Adjusting the Flat Panel to the Original Position

- 1) Place one hand at the center top edge of the flat panel.
- 2) Place the other hand on the center bottom edge of the flat panel.
- 3) Using the upper hand, gently push the top of the flat panel towards the wall. While the lower hand gently pulls the bottom of the flat panel away from the wall.

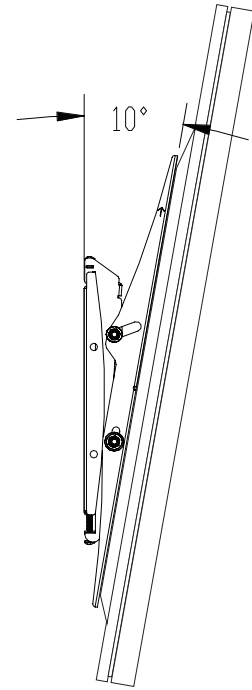

Utilizing the Security Barrel

Your P4263T Mount includes one (1) Security Barrel which can provide additional theft deterrence for your flat panel.

PCB-CSL1 Security Cable

- 1) Thread the cable through the hole on the security barrel.
- 2) Attach the PCB-CSL1 locking mechanism and secure it using the supplied key.

Padlock

- 1) Place the locking hook through the hole of the security barrel.
- 2) Snap lock and locking hook together.

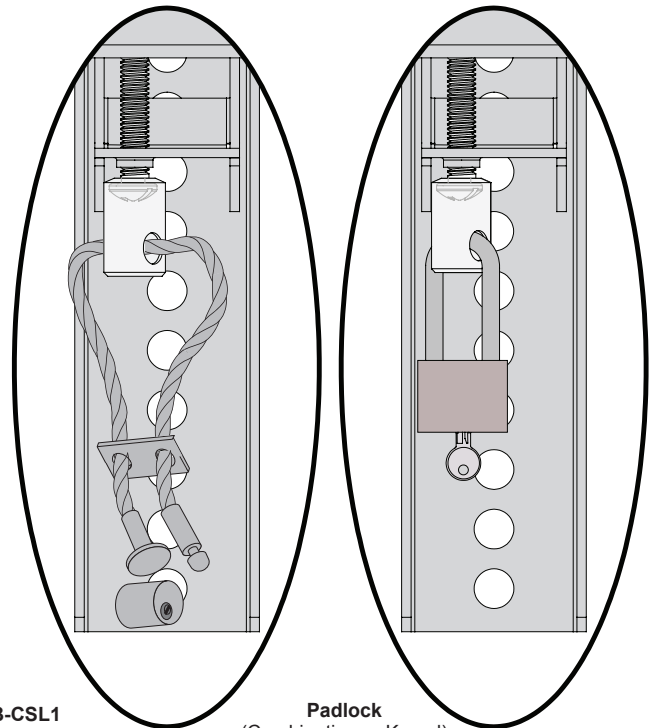

PCB-CSL1

Padlock
(Combination or Keyed)