

INSTALLATION INSTRUCTIONS

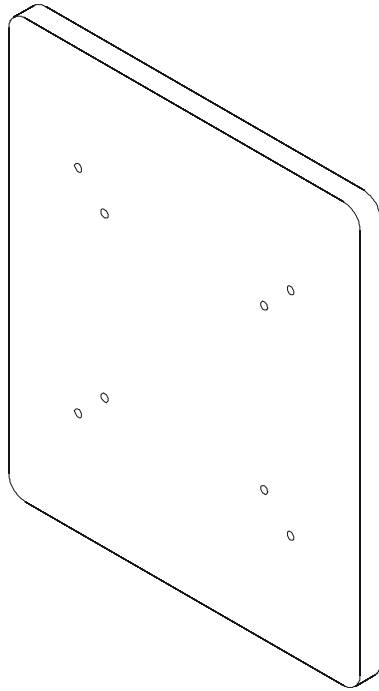

ED-WGH4

Monitor Arm Adapter Plates

ED-WGH4

DISCLAIMER

This manual is intended to be accurate and complete. However no claims are made that the information contained here covers all details, conditions or variations, nor does it provide for every possible contingency in connection with the installation or use of this product. No representation of warranty is made regarding information contained here. The information contained in this document is subject to change without notice or obligation of any kind. No responsibility is assumed for accuracy, completeness or sufficiency of the information contained in this document.

! IMPORTANT SAFETY INSTRUCTIONS

! WARNING: A WARNING alerts you to the possibility of serious injury or death if you do not follow the instructions.

! CAUTION: A CAUTION alerts you to the possibility of damage or destruction of equipment if you do not follow the corresponding instructions.

! WARNING: Failure to read, thoroughly understand, and follow all instructions can result in serious personal injury, damage to equipment, or voiding of factory warranty! It is the installer's responsibility to make sure all components are properly assembled and installed using the instructions provided.

! WARNING: Exceeding the weight capacity can result in serious personal injury or damage to equipment! It is the installer's responsibility to make sure the combined weight of all components located between the ED-WGH4/2 does not exceed the weight limit of the mount to which it is being attached.

! WARNING: Use this mounting system only for its intended use as described in these instructions. Do not use attachments not recommended by the manufacturer.

! WARNING: Never operate this mounting system if it is damaged. Return the mounting system to a service center for examination and repair.







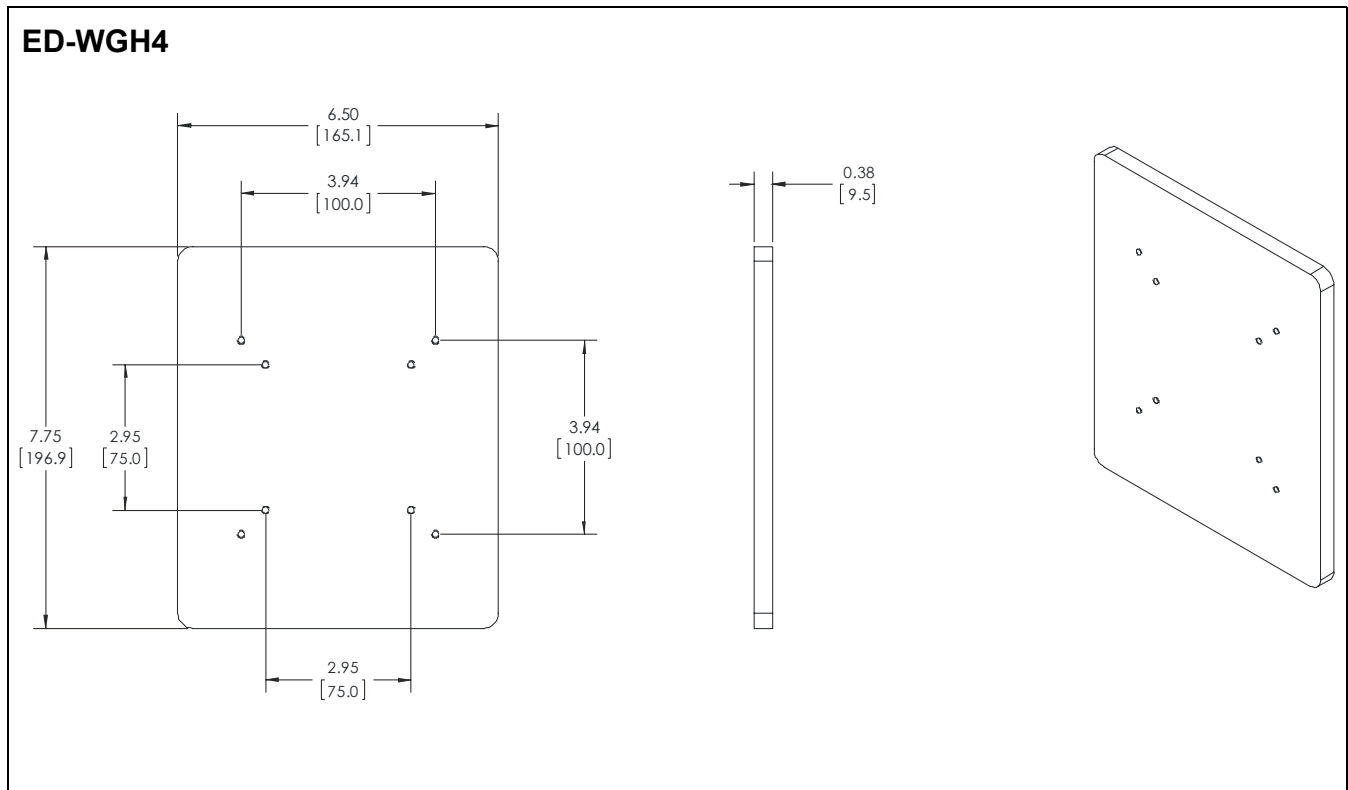





! WARNING: Do not use this product outdoors.

--SAVE THESE INSTRUCTIONS--

DIMENSIONS



LEGEND

	Tighten Fastener Apretar elemento de fijación Befestigungsteil festziehen Apertar fixador Serrare il fissaggio Befestiging vastdraaien Serrez les fixations		Pencil Mark Marcar con lápiz Stiftmarkierung Marcar com lápis Segno a matita Potloodmerkten Marquage au crayon
	Loosen Fastener Aflojar elemento de fijación Befestigungsteil lösen Desapertar fixador Allentare il fissaggio Befestiging losdraaien Desserrez les fixations		Drill Hole Perforar Bohrloch Fazer furo Praticare un foro Gat boren Percez un trou
	Phillips Screwdriver Destornillador Phillips Kreuzschlitzschraubendreher Chave de fendas Phillips Cacciavite a stella Kruiskopschroevendraaier Tournevis à pointe cruciforme		Adjust Ajustar Einstellen Ajustar Regolare Afstellen Ajuster
	Open-Ended Wrench Llave de boca Gabelschlüssel Chave de bocas Chiave a punte aperte Steeksleutel Clé à fourche		Remove Quitar Entfernen Remover Rimuovere Verwijderen Retirez
	By Hand A mano Von Hand Com a mão A mano Met de hand À la main		Optional Opcional Optional Opcional Opzionale Optie En option
	Hex-Head Wrench Llave de cabeza hexagonal Sechskantschlüssel Chave de cabeça sextavada Chiave esagonale Zeskantsleutel Clé à tête hexagonale		Security Wrench Llave de seguridad Sicherheitsschlüssel Chave de segurança Chiave di sicurezza Veiligheidssleutel Clé de sécurité

TOOLS REQUIRED FOR INSTALLATION

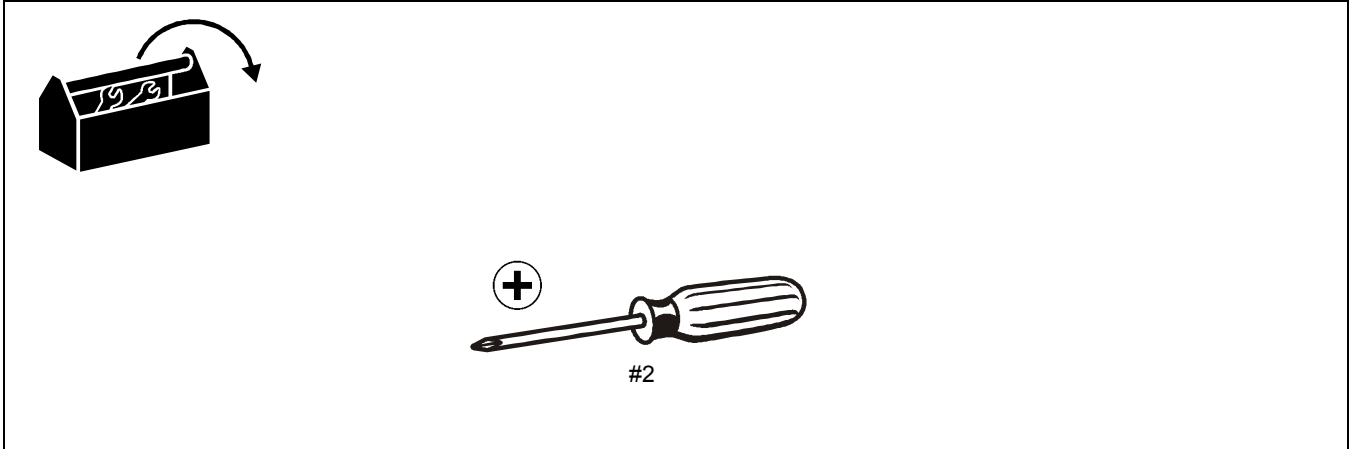

PARTS

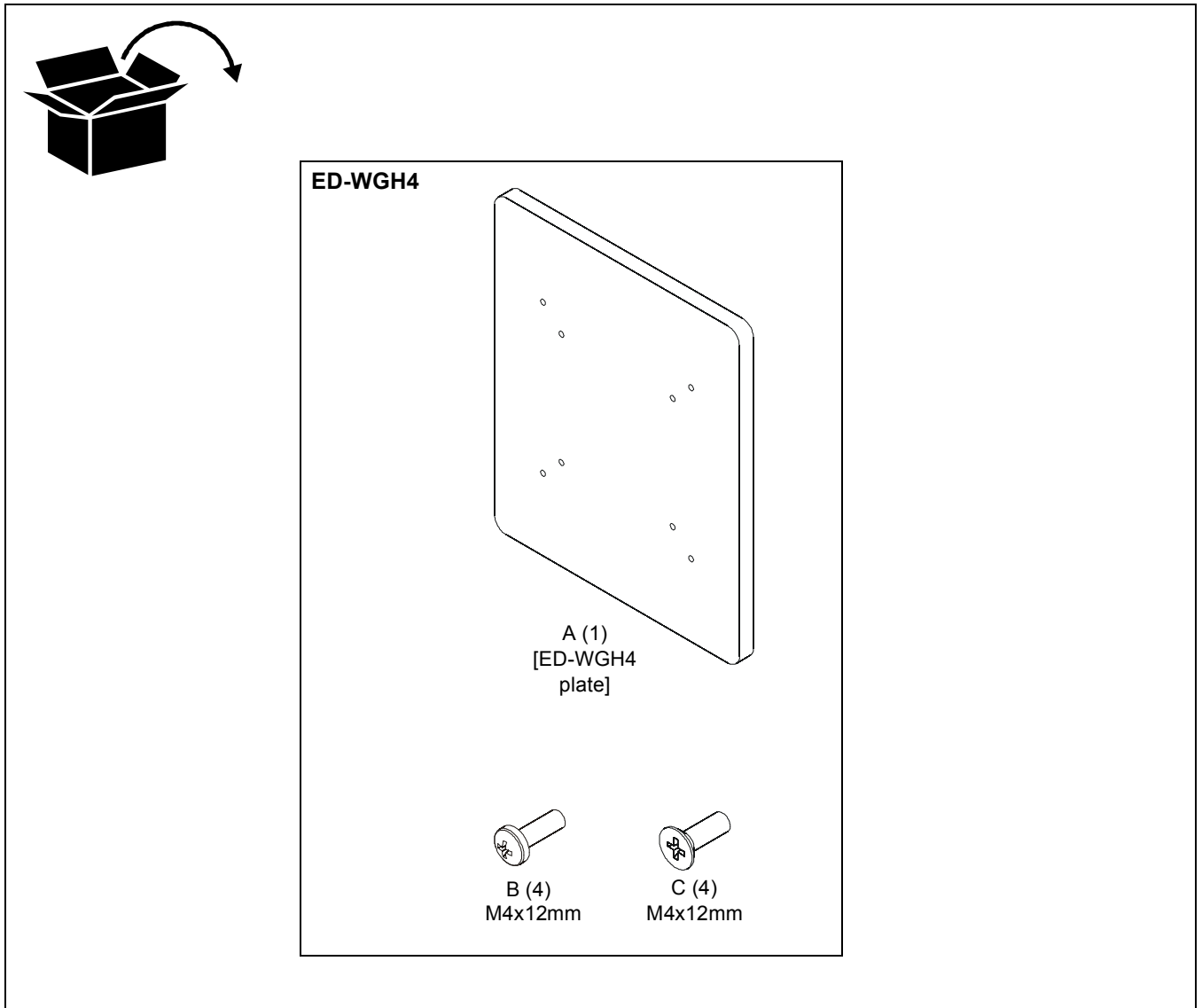

Installation of ED-WGH

1. Remove VESA adapter plate from back of monitor.
2. Place ED-WGH4 between VESA adapter and the back of the monitor.
3. Run four M4-0.7 bolts through VESA/ED-WGH/ Monitor and firmly tighten.

Note: Included M4-0.7 x 20 mm bolts work with a majority of monitors.

