

ergotron®

moving you forward

CareFit Combo System

- Flexible workflows: Easy screensharing and one-hand stowing enhances patient interactions
- Comfortable documentation: Offers ergonomic height-adjustment, optional worksurface and intuitive access to tools
- Neat workspace: Concealed cable management minimizes clutter and supports infection control
- Supports uptime: Convenient cord access simplifies maintenance with timely support available from our expert team
- Warm aesthetic: Modular wall mount enhances new and existing healing spaces
- Quality construction: Sturdy design supports multiple configurations and installation options



FOSTER NURSE-PATIENT CONNECTIONS AND
EASILY ADAPT TO CHANGING WORKFLOWS

CAREFIT™

Support genuine patient connections and help reduce the risk of errors with the modular CareFit Combo System that enables an efficient and comfortable documentation experience at the point of care. Easy screensharing, one-hand stowing and intuitive access to tools allow nurses to focus on patient care. The design enhances healing spaces with concealed cable management that promotes infection control, serviceability and uptime for IT teams.

CAREFIT™

Provides *nurses* with renewed control over individual workflows and health to help facilitate efficient documentation and foster patient relationships.

Hidden cable management and simple cord access makes it easy for *IT teams* to maintain or upgrade workstations so they can efficiently get the job done.

MODULAR – FULL-MOTION – CUSTOMIZABLE

- 1 Personalized, ergonomic monitor positioning for each user with 180° of pan and 5" (13 cm) of independent adjustment
- 2 Provides up to 65" (165 cm) of reach by using an extender for documentation at a patient's bedside or in a private space
- 3 Wall Track covers create a clean, streamlined look with hidden cabling
- 4 Space-saving design easily folds when not in use to open up more work area
- 5 Support neat, healing spaces with concealed cable management that enhances infection control
- 6 Enable efficient, secure access with space for an RFID employee badge reader
- 7 Offer greater visibility to data by upgrading the workstation to hold two LCD monitors

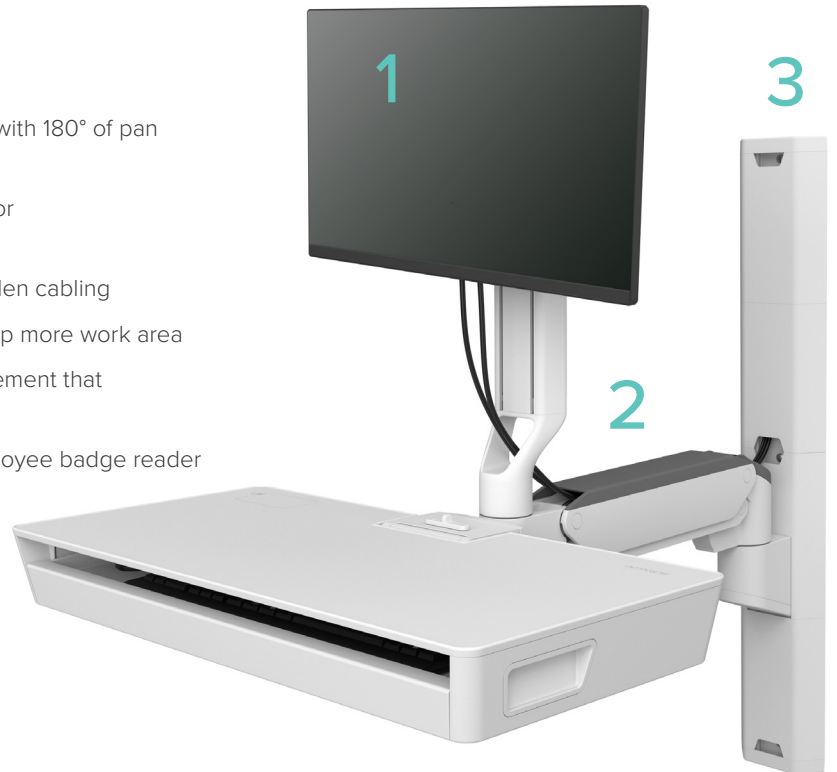

CAREFIT™



Thoughtful ergonomics for comfortable caregiving

INTUITIVE WORKFLOWS

- 1 Extension helps minimize the distance and steps to the patient
- 2 Full unit moves together with a light touch to give caregivers flexibility and choice
- 3 Supports caregiver-patient engagement with independent monitor adjustment
- 4 Convenient scanner access with multiple installation locations



SPACE-SAVING STORAGE

- 5 Help reduce the risk of errors by mounting a printer for efficient workflows
- 6 Locks in place for secure stowing upright in front of the monitor



THE DESIGN ENHANCES HEALING SPACES WITH CONCEALED CABLE MANAGEMENT THAT PROMOTES INFECTION CONTROL, SERVICEABILITY AND UPTIME FOR IT TEAMS.

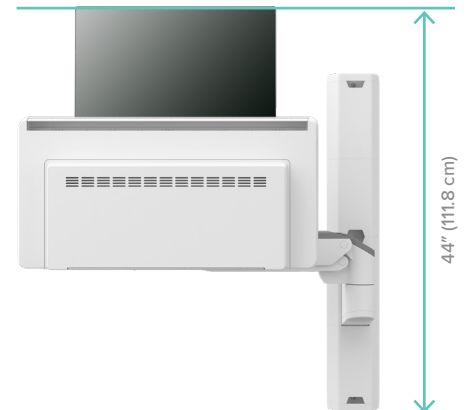

CPU under worksurface tray:
Total height with CPU box is 44" (111.8 cm)

Configure your wall system for your workflow

STEP 1: SELECT YOUR BASE UNIT



CareFit Combo Arm



CareFit Combo Arm
with Worksurface



CareFit Combo System



CareFit Combo System
with Worksurface

STEP 2: DETERMINE IF YOU NEED ADDITIONAL REACH



CareFit Combo Extender, Short

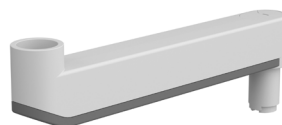

CareFit Combo Extender

STEP 3: CONSIDER UPGRADING TO A DUAL MONITOR SETUP



CareFit Combo Dual Monitor Kit

STEP 4: SELECT YOUR CPU STORAGE

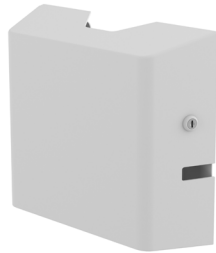

CPU Wall Cabinet

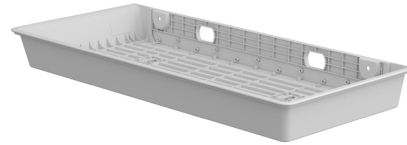

CareFit Combo CPU Tray

STEP 5: SELECT YOUR SCANNER HOLDER



Top-Mount Scanner Holder,
VESA Attach



CareFit Combo Wireless
Scanner Bracket



CareFit Combo
Scanner Bracket

STEP 6: SELECT YOUR WALL-MOUNTED PRINTER BRACKET

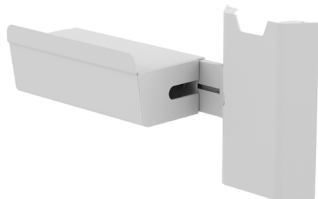

Printer Bracket for Wall Track



Printer Bracket for Wall Track, Large

STEP 7: ADD AN OPTIONAL SIGNATURE PAD HOLDER



CareFit Combo Signature Pad Holder

CAREFIT™

LARGE ACCESSORY PORTFOLIO
FITS YOUR UNIQUE NEEDS

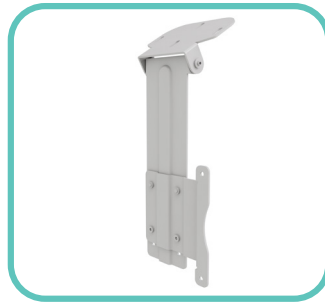

**Top-Mount Scanner Holder,
VESA Attach
98-649-251**

Supports efficient workflows with
hands-free scanning



**CareFit Combo Wireless
Scanner Bracket
98-549-251**

Supports efficient workflows with
installation on either side



**CareFit Combo Scanner Bracket
98-551-251**

Supports efficient workflows with
installation on either side



**CareFit Combo Signature Pad Holder
31-018-216**

Encourages digital workflows and saves
time with easy access to a signature pad

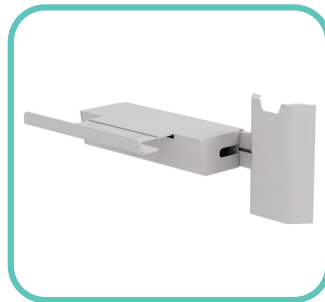

**Printer Bracket for Wall Track, Large
98-647-251**

Keeps larger printers in reach to
maximize time with patients; installs
anywhere on Wall Track

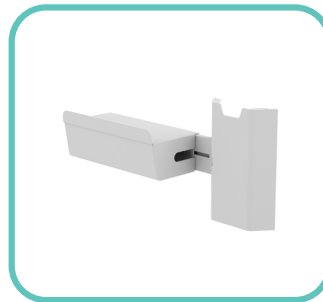

**Printer Bracket for Wall Track
98-578-251**

Keeps printer in reach to maximize time
with patients; installs on either side

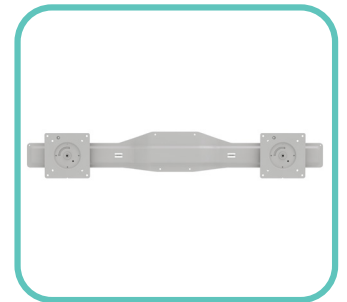

**CareFit Combo Dual Monitor Kit
98-650-251**

Displays more information at once with
two screens up to 24 inches (61 cm) each

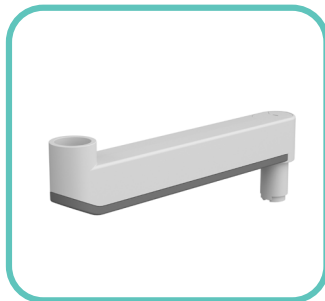

**CareFit Combo Extender
98-547-251**

Provides extra reach and flexibility for
larger care applications



**CareFit Combo Extender, Short
98-648-251**

Provides extra reach and flexibility for
smaller care applications



**CPU Wall Cabinet
98-543-251**

Clean design keeps CPU secure and
extra cables and power brick out of view

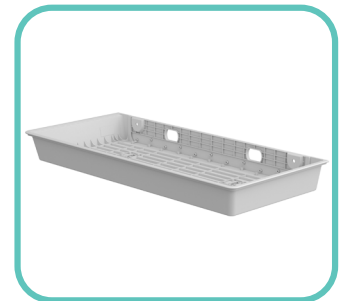

**CareFit Combo CPU Tray
98-548-251**

Saves valuable wall space by installing
under the worksurface

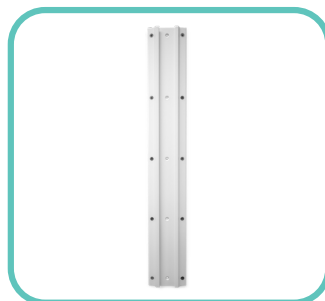

**34" Wall Track
31-018-216**

Enables a sturdy installation;
required for CareFit Combo Arm



**CareFit Wall Track 34" Covers
98-609-030**

Hides cabling for a neat look and
supports infection control

CAREFIT™

Multiple configurations to fit any workflow



CareFit Combo System with Large Printer Bracket, Signature Pad Holder, Short Extender, Top-Mount Scanner Holder and CPU Tray



CareFit Combo System with Worksurface, Large Printer Bracket, Signature Pad Holder, Short Extender, Top-Mount Scanner Holder and CPU Tray



CareFit Combo System with Dual Monitor Kit, Printer Bracket, Signature Pad Holder, Short Extender, Wireless Scanner Bracket and CPU Wall Cabinet



CareFit Combo System with Worksurface, Dual Monitor Kit, Large Printer Bracket, Signature Pad Holder, Wireless Scanner Holder, Extender, CPU Wall Cabinet



CareFit Combo System with Worksurface, Signature Pad Holder, Top-Mount Scanner Holder, Wireless Scanner Bracket, Extender and CPU Tray

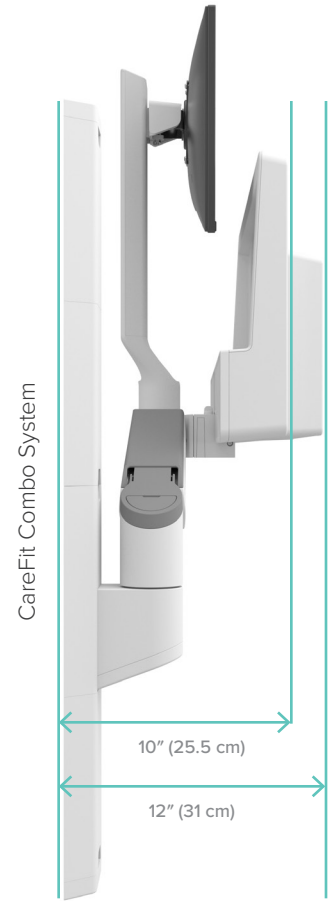

Folds close to the wall when not in use to maximize space

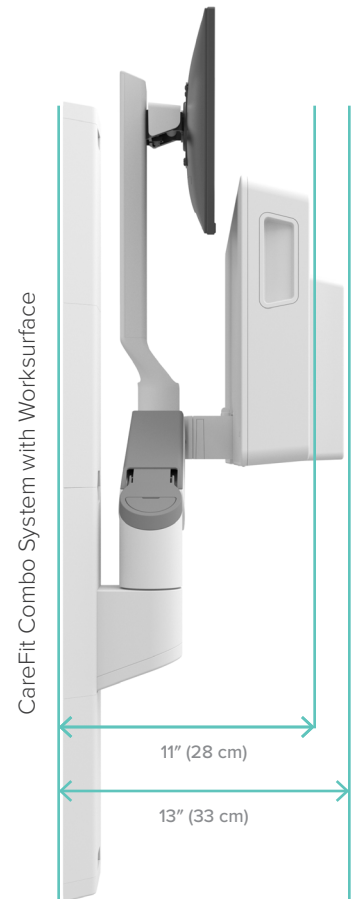



Combo Arm



**Combo Arm
with Worksurface**



Combo System



**Combo System
with Worksurface**

Part # (white)	45-621-251	45-622-251	45-618-251	45-619-251
	Extender 98-547-251			
Typical LCD Size	≤ 27"			
LCD SIZE IS APPROXIMATION. DIMENSION IS DIAGONAL MEASUREMENT OF SCREEN. LCD SIZE MAY BE EXCEEDED AS LONG AS SCREEN WEIGHT DOES NOT EXCEED MAXIMUM WEIGHT CAPACITY OF THE MOUNT.				
Weight Capacity	LCD: 8–22 lbs (3.6–10 kg) Worksurface: 1.5 lbs (0.68 kg)			
Lift	20" (51 cm)			
Tilt	LCD: 25° ↑ 20° / ↓ 5° Worksurface: 90°			
Pan	180°			
Rotation	180°			
VESA	MIS-D (100 x 100 mm & 75 x 75 mm)			
Extension	Adds additional 18.5" (47.1 cm) extension from the wall			
Extension (with extender accessory)	57.8" (146 cm)	65.3" (165.7 cm)	57.8" (146 cm)	65.3" (165.7 cm)
Extension (with short extender accessory)	48.9" (113.3 cm)	56.4" (133 cm)	48.9" (113.3 cm)	56.4" (133 cm)
Product Weight	38.9 lbs (17.6 kg)	40.2 lbs (18.2 kg)	45.9 lbs (20.8 kg)	47.3 lbs (21.5 kg)
Shipping Dimensions	44.6" x 18.9" x 11.8" (113.3 x 48 x 29.9 cm)	44.6" x 18.9" x 11.8" (113.3 x 48 x 29.9 cm)	44.6" x 20.9" x 11.8" (113.3 x 53.2 x 29.9 cm)	44.6" x 20.9" x 11.8" (113.3 x 53.2 x 29.9 cm)
Shipping Weight	48.5 lbs (22 kg)	49.4 lbs (22.4 kg)	56.2 lbs (25.5 kg)	57.7 lbs (26.2 kg)
Warranty	5 years			

CLEANING RECOMMENDATIONS

You can use most hospital-grade, diluted, non-abrasive, non-corrosive cleaning agents with this product. Reference our [cleaning guide](#) for helpful tips and tested solutions.

Download additional resources at ergotron.com.

For more information:

USA & Canada: 800.888.8458 / +1.651.681.7600 / insidesales@ergotron.com

EMEA: +31.33.45.45.600 / info.eu@ergotron.com

APAC: apaccustomerservice@ergotron.com

LATAM: +1.800.681.1820 / info.latam@ergotron.com

Custom: custom@ergotron.com

© Ergotron, Inc. 09.05.2023

Literature made in the U.S.A.

Content subject to change.

Ergotron devices are not intended to cure, treat, mitigate or prevent any disease.

Patent information available at www.ergotron.com/patents.

