

ergotron®

LiFeKinnex™ Smart Battery Dock

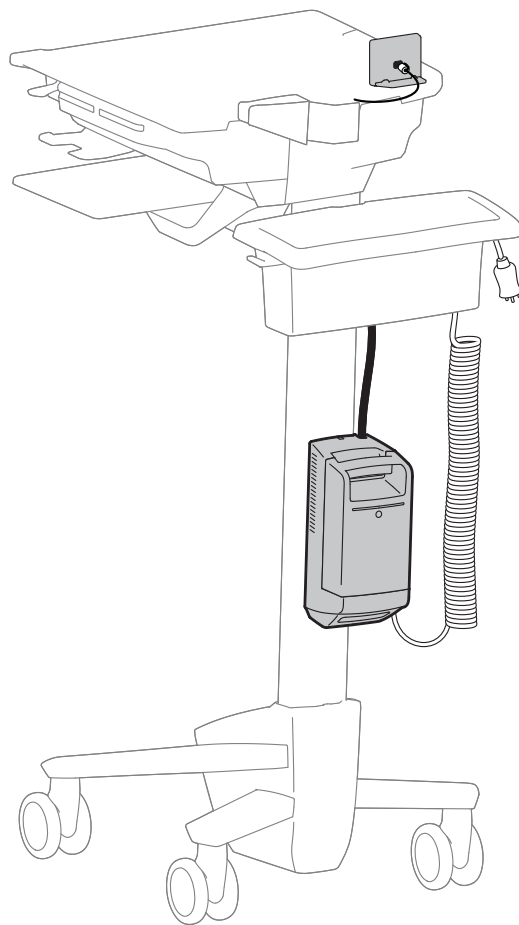

English

The LiFeKinnex Power Module is intended to provide uninterrupted AC power to support AC powered computer equipment.

The Power Module is not intended to power medical products or devices.

Please review this manual before installing your equipment to learn how to use this product safely.

This product is a certified medical power module according to IEC/EN 60601-1, as class I equipment. This power module is intended for use with IEC 60601-1 certified equipment in the patient Environment and IEC 60601-1 and IEC 60950-1 certified equipment outside of patient environment.

AC input: 100-240V~ 50/60-Hz. Max amps: 4.8 - 2.1A.

Manufactured for Ergotron by Green Cubes Technology www.greencubestech.com

Patents Ergotron.com/patents

Battery Sold Separately.



For the latest User Installation Guide please visit: www.ergotron.com



English, Español, Français, Deutsch, Nederlands, Italiano, Svenska, 日本語, 汉语

www.ergotron.com | USA: 1-800-888-8458 | Europe: +31 (0)33-45 45 600 | China: 400-120-3051 | Japan: japansupport@ergotron.com

Safety

Hazard Symbols Review

These symbols alert users of a safety condition that demands attention. All users should be able to recognize and understand the significance of the following Safety Hazards if encountered on the product or within the documentation. Children who are not able to recognize and respond appropriately to Safety Alerts should not use this product without adult supervision!

Symbol	Signal Word	Level of Hazard
	INSTRUCTIONS	Refer to instruction manual/booklet. Follow instructions for use.
	CAUTION	A CAUTION indicates either potential damage to hardware or loss of data and tells you how to avoid the problem.
	WARNING	A WARNING indicates either potential for property damage, personal injury, or death.
	DANGER	A DANGER indicates a hazardous situation that, if not avoided, will result in death or serious injury.

Equipment Electrical Safety



WARNING: Failure to observe the following Electrical Safety notices can result in fire or death by electric shock.

Electrical cables can be hazardous. Misuse can result in fire or death by electrical shock.

- Inspect power cables thoroughly before each use.
- Do not use cables that are damaged.
- Insert the plug completely into the outlet.
- Grasp the plug to remove from the outlet.
- Do not unplug by pulling on the cable.
- Do not use excessive force to make connections.
- Do not plug the cable into an extension cable.
- Do not remove, bend or modify any metal prongs or pins of cable.
- Do not drive, drag or place objects over the cable.
- Do not walk on the cable.
- Avoid overheating.
- Do not run cable through doorways, holes in ceilings, walls or floors.

Keep away from water.

- Do not use it when wet.
- Do not place in close proximity to flammable liquids or gases.

This AC power cord and tap are for Ergotron equipment only. Do not use it for other equipment.



WARNING: Use of this equipment adjacent to or stacked with other equipment should be avoided because it could result in improper operation. If such use is necessary, this equipment and the other equipment should be observed to verify that they are operating normally.



WARNING: Use of accessories, transducers and cables other than those specified or provided by the manufacturer of this equipment could result in increased electromagnetic emissions or decreased electromagnetic immunity of this equipment and result in improper operation.

CAUTION: The power disconnect for this equipment is the AC power cable.

Do not use this unit outdoors.

Never unplug this product from the outlet when your hands are wet.

Any modifications made to this device that are not approved, may void the authority granted to the user by the FCC to operate this equipment.

Ensure the product is connected to an outlet having the same configuration as the plug. No adapter should be used with this product.

Ergotron does not accept any liability for damage if the unit is misused, incorrectly operated or inadequately repaired. Under these circumstances the warranty will be void.

CAUTION: To avoid the potential to pinch cables it is important to follow the cable routing instructions in this manual. Failure to follow these instructions may result in equipment damage or personal injury.

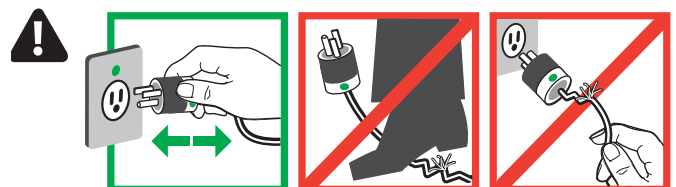

DANGER! Electrical cables can be hazardous. Misuse can result in fire or death by electrical shock.

Safety

Do not attempt to connect the power modules in serial or parallel with any other power modules. This system was not designed to serve this purpose. This power module shall be installed by qualified personnel only. The system shall be always installed in the vertical direction as shown in the picture on cover page.



WARNING: DO NOT charge battery with any other charger.



WARNING: Battery contains magnets. Magnets may be harmful to persons with implanted medical devices. Keep battery at least 6" (152 mm) away from any implanted medical devices.



WARNING: Keep battery and Power Module cool or at room temperature
Operating Temperature: 10°C to 40°C (50°F to 104°F)
Storage Temperature: -20°C to 45°C (-4°F to 113°F)



WARNING: Never attempt to open or service the battery.



WARNING: Never attempt to short circuit the battery or the Power Module intentionally.



WARNING: DO NOT drop, puncture or crush battery or expose to water.



WARNING: DO NOT dispose battery in fire in any circumstances. Keep battery pack away from any hot source.



WARNING: DO NOT use battery if physical damage is evident.



WARNING: To avoid risk of electric shock, do not expose electrical component to water, cleaning solution or other potentially corrosive liquids or substances.



WARNING: To avoid risk of electric shock, this equipment must be connected to AC mains with protective earth.



WARNING: In rare case, if the power module and battery protection features fail, the battery may become overcharged and in some instances, it may become extremely hot, possibly melting the plastics and releasing smoke.

If a battery begins to smoke or melts:

Unplug the cart, or if possible disconnect the battery from Power Module immediately.

Move the cart to a well-ventilated area.

Use a Carbon Dioxide, Dry Chemical, or appropriate foam fire extinguisher to spray the hot battery. If a fire extinguisher is not available, use copious amounts of water, or cover the battery with sand. Exposure to vapor released from the battery is irritating to the eyes, skin, mucous membranes, and respiratory tract.

This may cause nausea, dizziness, and headache.

In case of direct contact to the battery's electrolyte:

Immediately flush eyes with water for at least 15 minutes.

Thoroughly rinse hands and other affected areas with water.

Promptly remove and wash any contaminated clothing.

In all cases, seek immediate medical attention!

Placement:

Do not expose the Power Module to direct sunlight or other heat source.

Ensure the operating environment is well ventilated to allow adequate dissipation of heat.

Ensure the Power Module surrounding area is clean and free from moisture.

Do not put heavy objects on the Power Module.

The socket outlet should be easily accessible and should be installed near the equipment.

AC Inlet power cords:

AC mains plug shall have the protective earth pin. By connecting the plug to the Power Module, it shall have not more than 200mΩ to any part of the system metal case.

The connector shall be an IEC 60320 compliant C13 plug.

The power cords shall be IEC 60227 or HO5VV compliances.

AC Outlet power cords:

The connector shall be an IEC 60320 compliant C14 inlet.

The power cords shall be IEC 60227 or HO5VV compliant.

Features & Specifications

EMC levels are evaluated according to IEC60601-1-2/EN60601-1-2. This power module was not designed to be water proof, therefore, its classified as IPX0 and also not evaluated as AP/APG equipment.

Certification:

UL 60601-1 Safety of Medical Electrical Equipment
 CAN/CSA C22.2 No. 601.1
 IEC 60601-1
 ICES-003 Issue 5, Class A
 FCC Part 15 Class A
 RoHS and REACH compliant material used.

This device complies with Part 15 of the FCC Rules. Operation is subject to the following two conditions:

- 1) This device may not cause harmful interference.
- 2) This device must accept any interference received, including interference that may cause undesired operation.

CAN ICES3(A)/NMB-3(A).











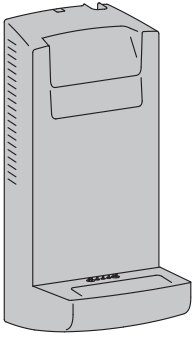

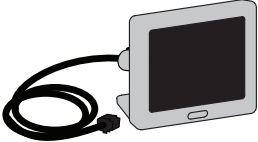

Changes or modifications not expressly approved by the Ergotron could void the user's authority to operate the equipment. Intended for institutional use.

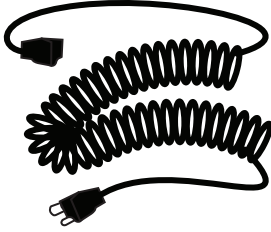
Note: The emissions characteristics of this equipment make it suitable for use in industrial areas and hospitals (CISPR 11 class A). If it is used in residential environment (For which CISPR 11 class B is normally required) this equipment might not offer adequate protection to radio-frequency communication services. Mitigation measures, such as relocating or re-orienting the equipment may be necessary.

Regulatory Model Number		APB-1112G	APB-1112H	APB-1112B	APB-1112	APB-1112C	APB-1112D	APB-1112F
Part Number		916-501-00	916-338-00	916-499-00	916-334-00	916-337-00	916-336-00	916-335-00
Input	Voltage Range	100~ 240Vac						
	Frequency	50 / 60 Hz						
	Power Factor	PF>0.94/230Vac PF>0.98/115Vac						
Output	Voltage Range (+/-3%)	100Vac	100Vac	120Vac	120Vac	127Vac	220Vac	230Vac
	Frequency (+/-1 Hz)	50	60	50	60	60	60	50
	Wave form	Pure Sine Wave						
	Output Power (Continuous)	150VA						
	Output Power (Maximum)	180VA average up to 5 minutes						
	Output Power (Peak)	200VA average up to 1 second						
Swappable Battery Lithium Iron Phosphate 245Wh 916-333-00	Nominal Voltage	12.8V						
	Nominal Capacity	19.2Ah/245Wh						
	Charging Voltage	14.4V						
	Maximum Charging Current	15A						
	Maximum Discharge Current	21A						
	Approximate Weight	6.2lbs						
	Communication	SMBUS						
Operating Ambient Temperature		10° to 40°C						
Transportation Temperature/Humidity		-20° to +70°C/ 5% to 95%						
Storage Temperature/Humidity		-20° to +45°C/ 5% to 95%						
Ambient Relative Humidity		20 to 90% Non-Condensing						
Operating Altitude		4000 meters						

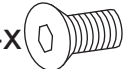

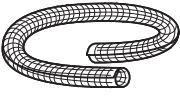
Components

	A	B	C	D
1	1x  Power Module	1x  Bottom Cover	1x  Back Cover	1x  Mounting Bracket
2	1x  Display	1x  Power Strip	1x  Coiled Cord	2x  T-Slot Bracket
3	1x  Display Base	5x  M3 x 8mm Screw	1x  M4 x 8mm Screw	4x  M5 x 10mm Screw
4	4x  Cable Tie	1x  Cable Wrap	1x  Hex Wrench	

Battery Sold Separately.
Lithium Iron Phosphate 245Wh, 916-333-00



Tools Needed



- 1** Remove any T-Slot mounted components from your cart that would interfere with the installation of the Power Module. SV41 cart shown here.

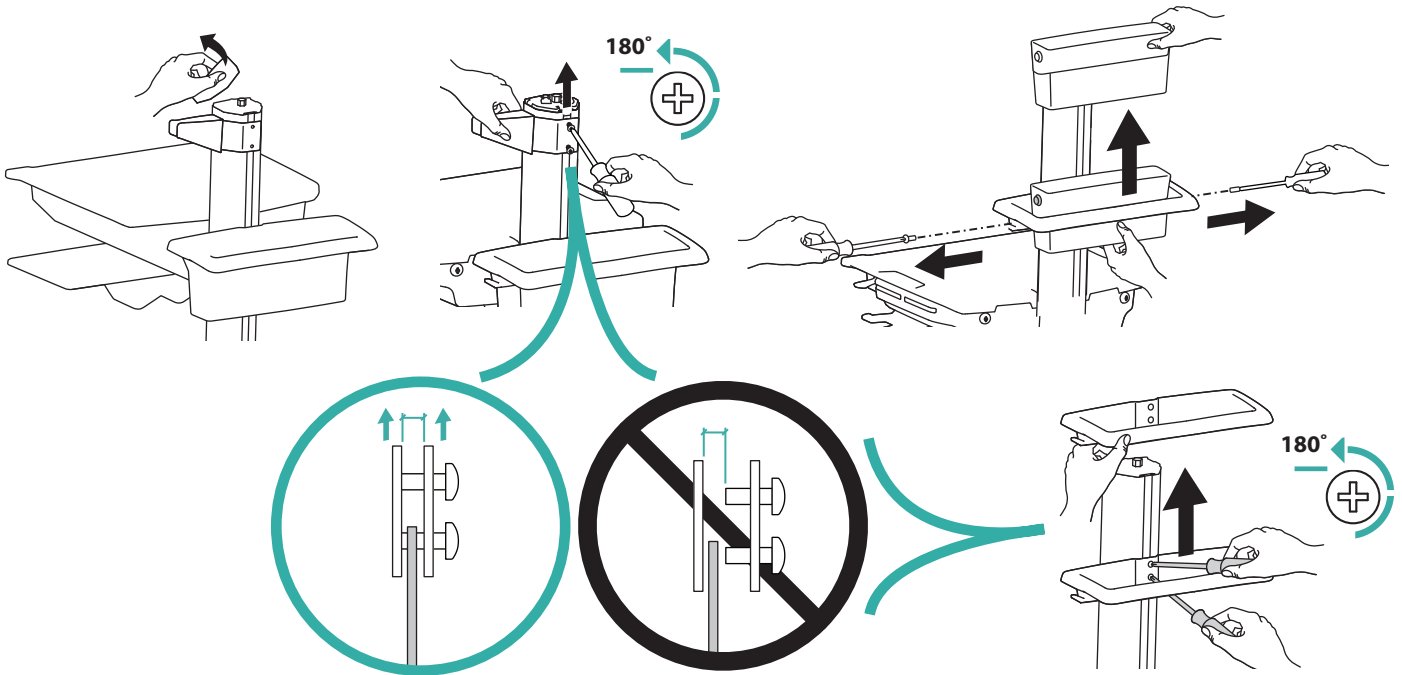

- 2** Assemble the Mounting Bracket and T-Slot Brackets.

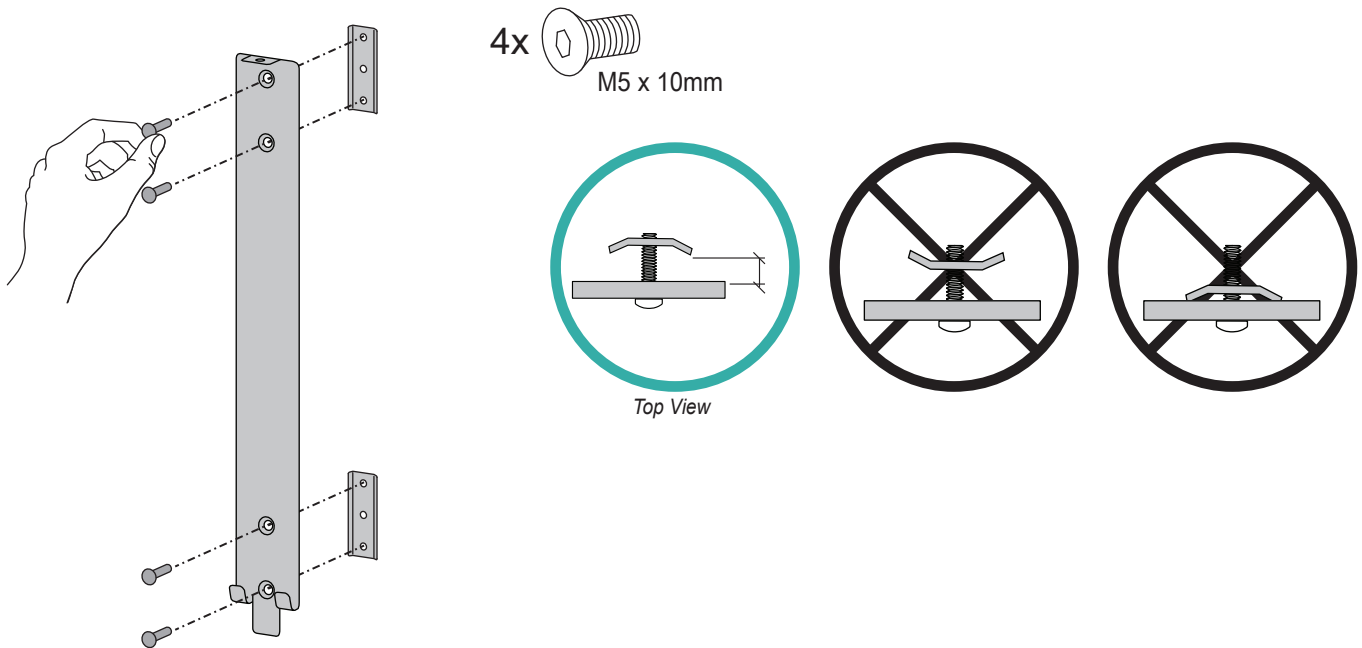

3

Attach the T-Slot Bracket to your cart's T-Slot.

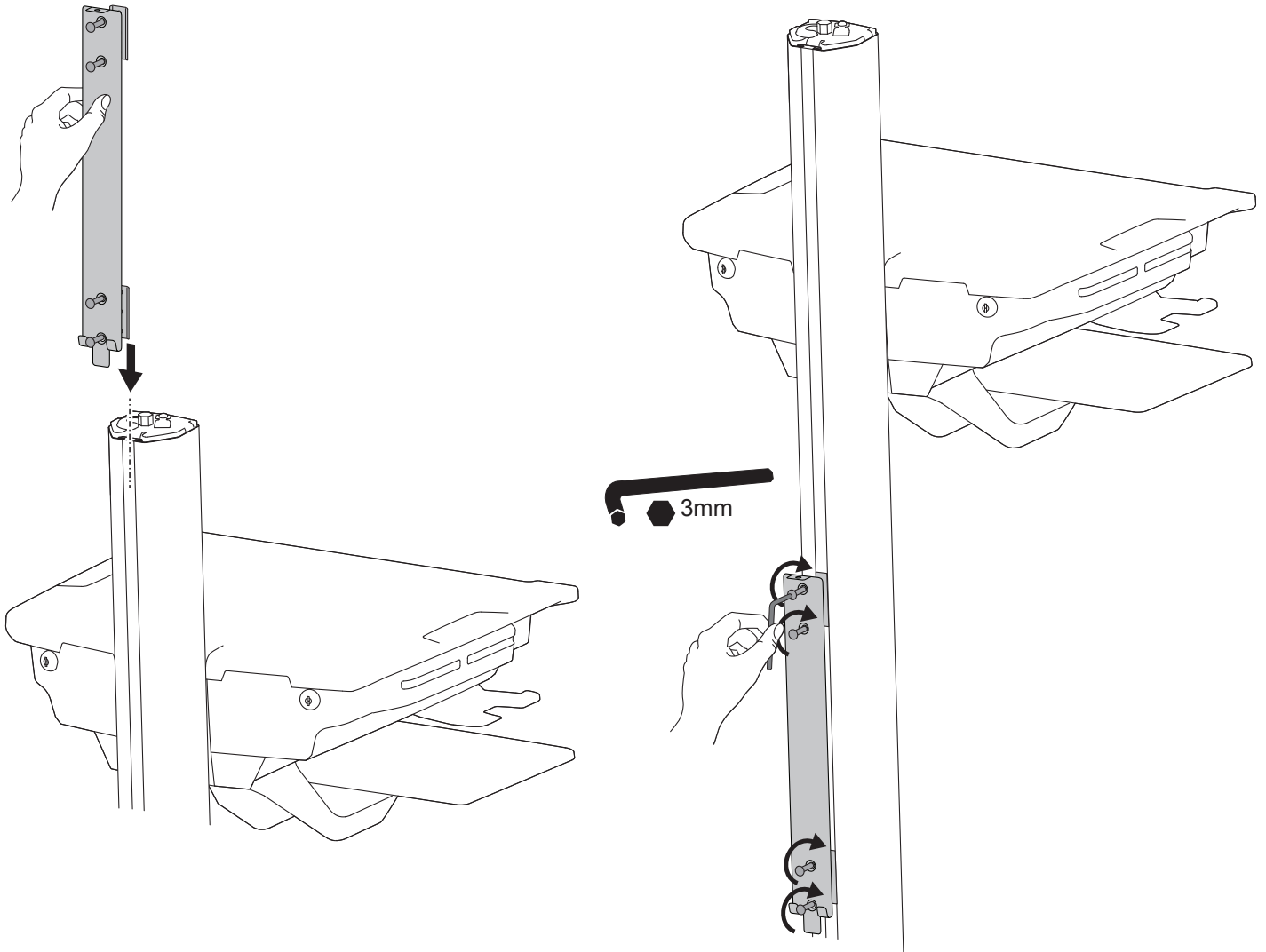

4

Attach the Display to your desired location on your cart.

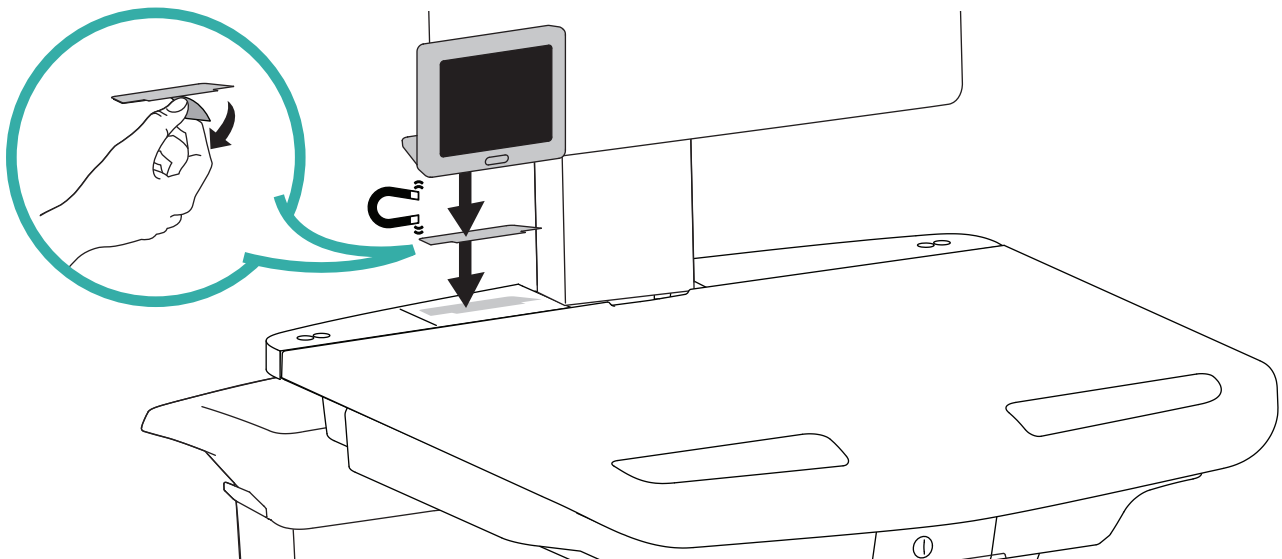

5

Open your cart's storage area and place the Power Strip in there. Route the Display and Power Strip cables down through storage area to the base of the cart.

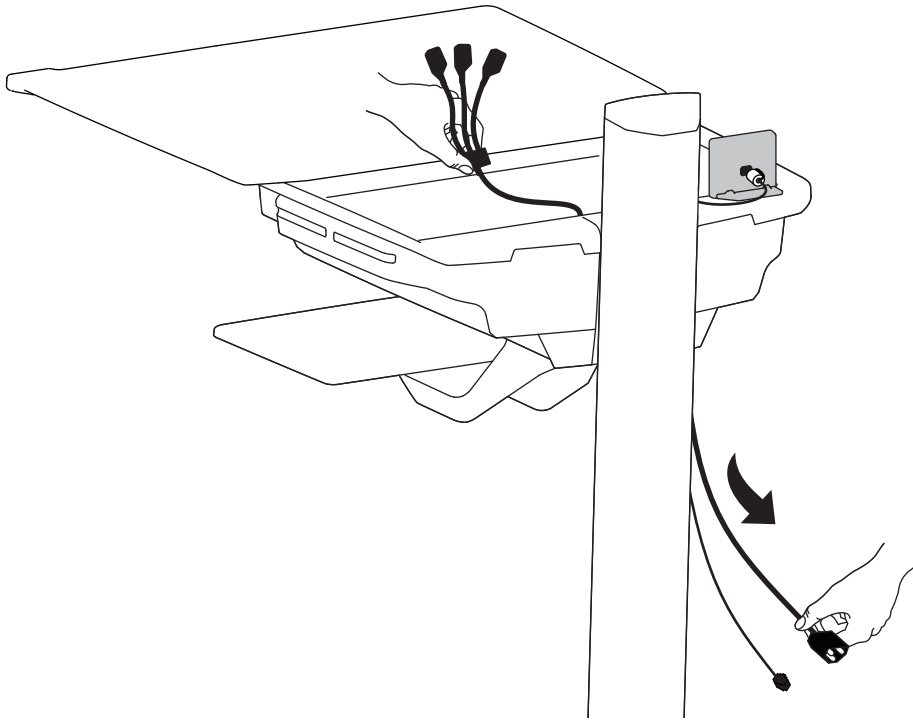

6

Plug in all 3 cables to the Power Module.

 **WARNING:** Connecting electrical equipment to the outlet effectively leads to creating a medical system and the result can be a reduced level of safety.

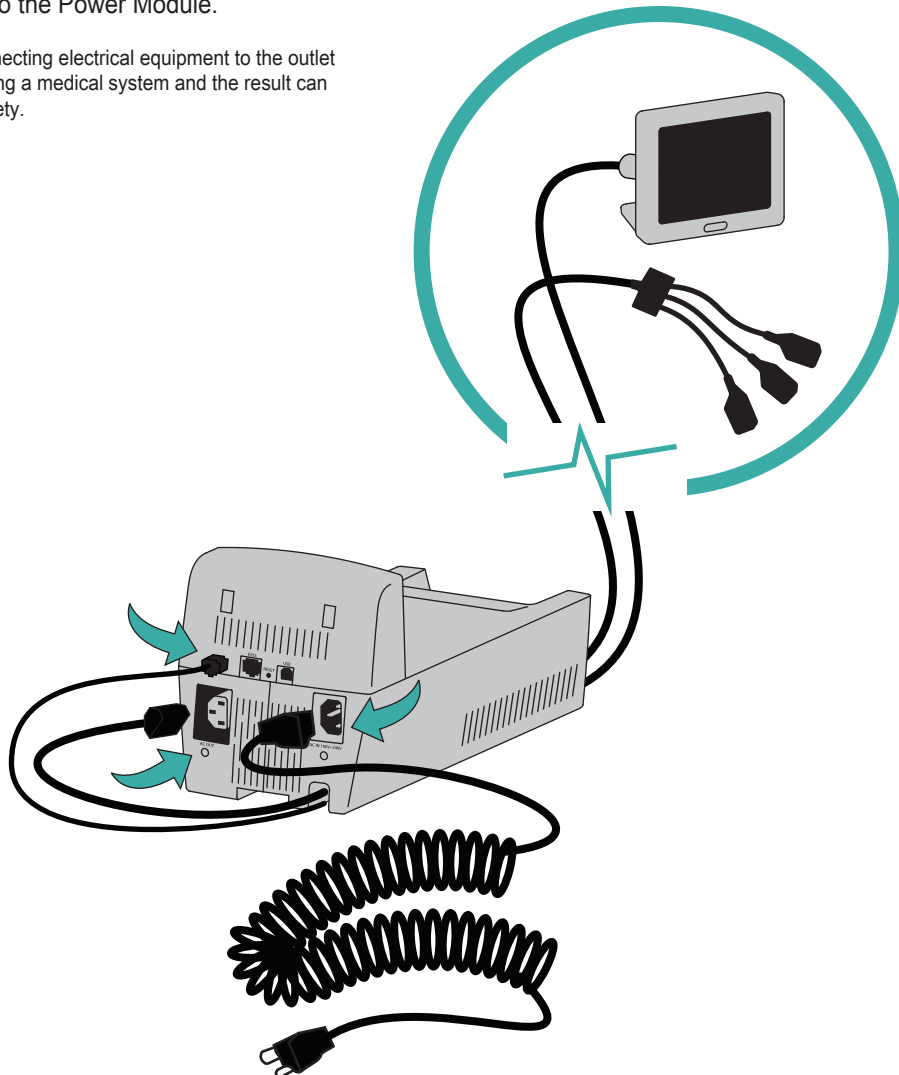

7

Attach Bottom Cover routing Coiled Cord out the side and routing Display and Power Strip cables up through the back channel.

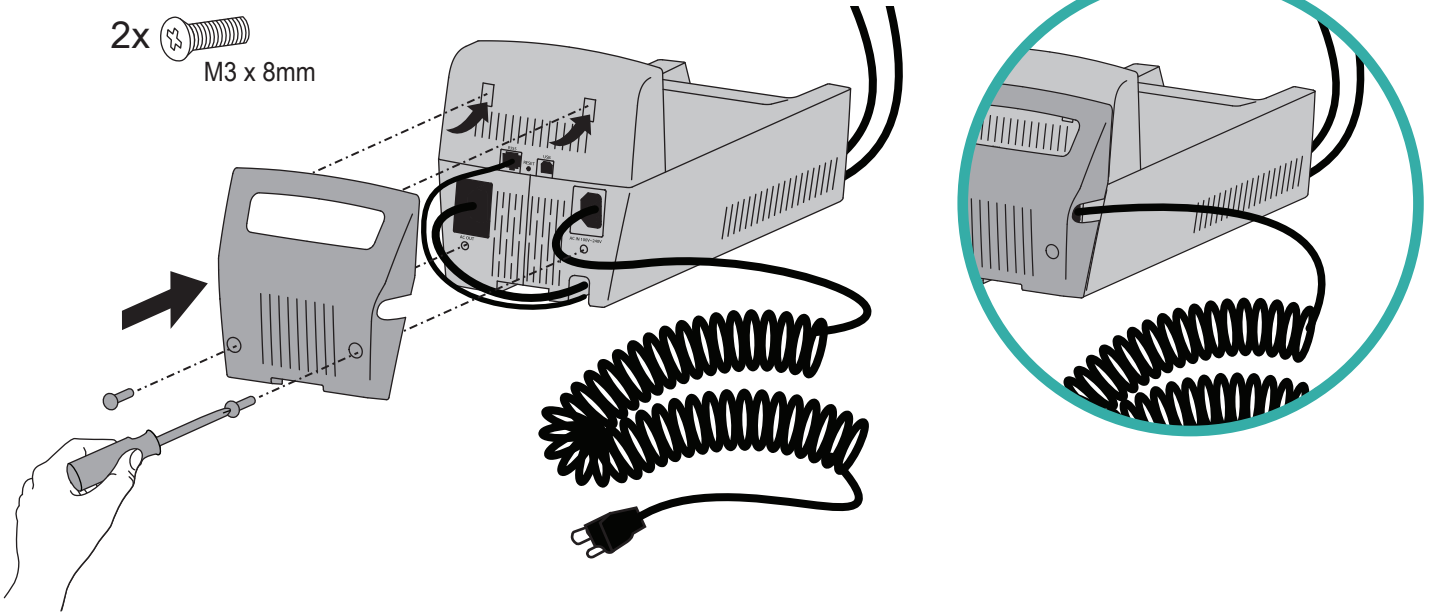

8

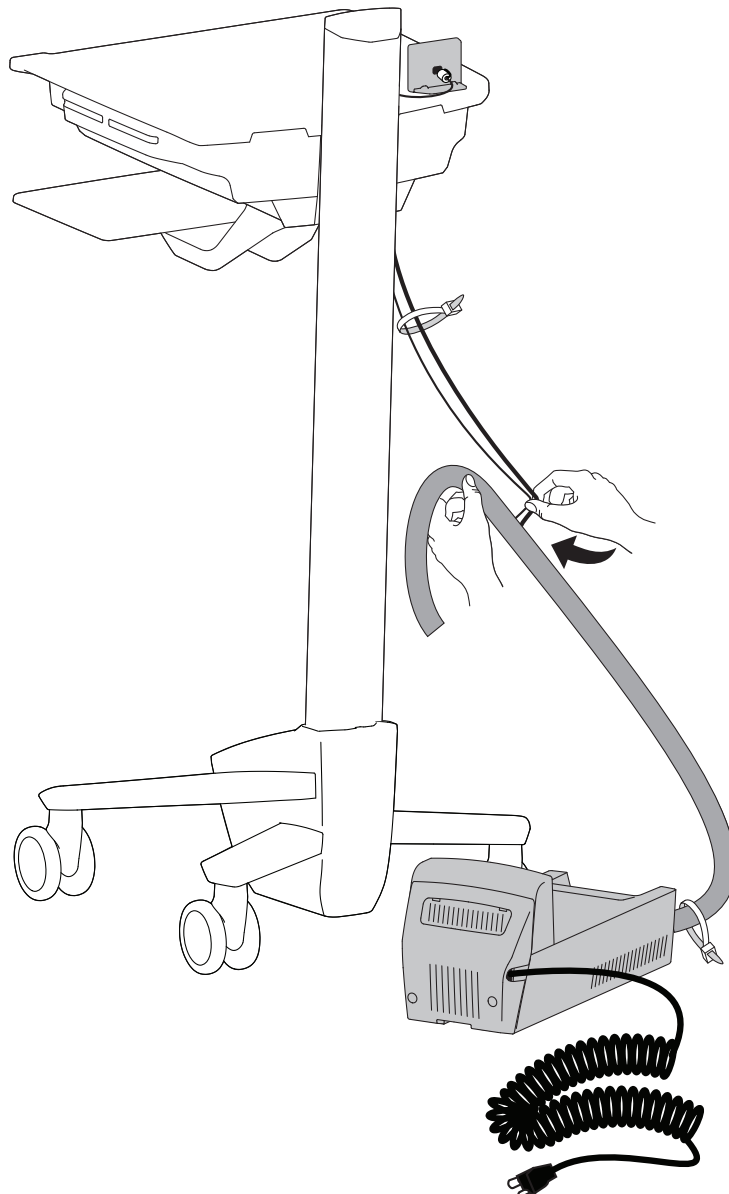
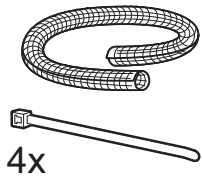

9

Attach Back Plate keeping Display and Power Strip cables in the Channel.

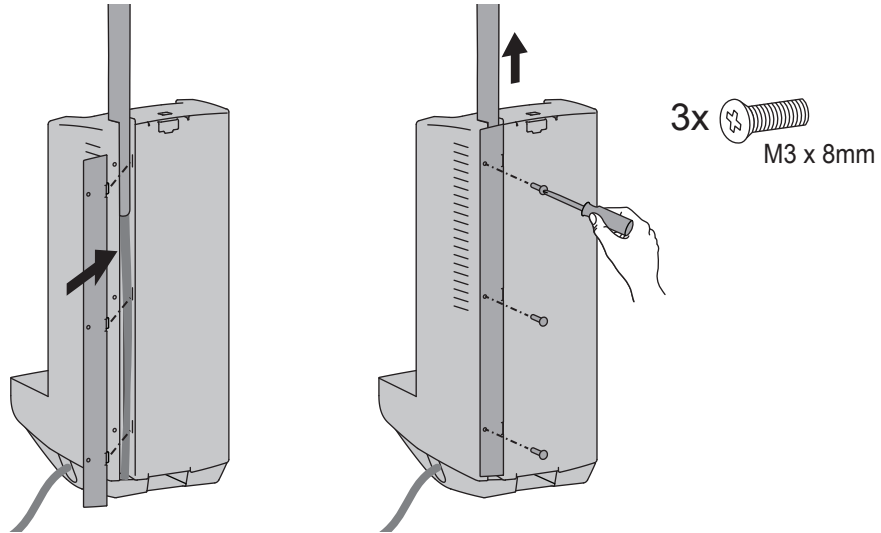

10

Attach Power Module to Mounting Bracket on Cart and secure with a screw.

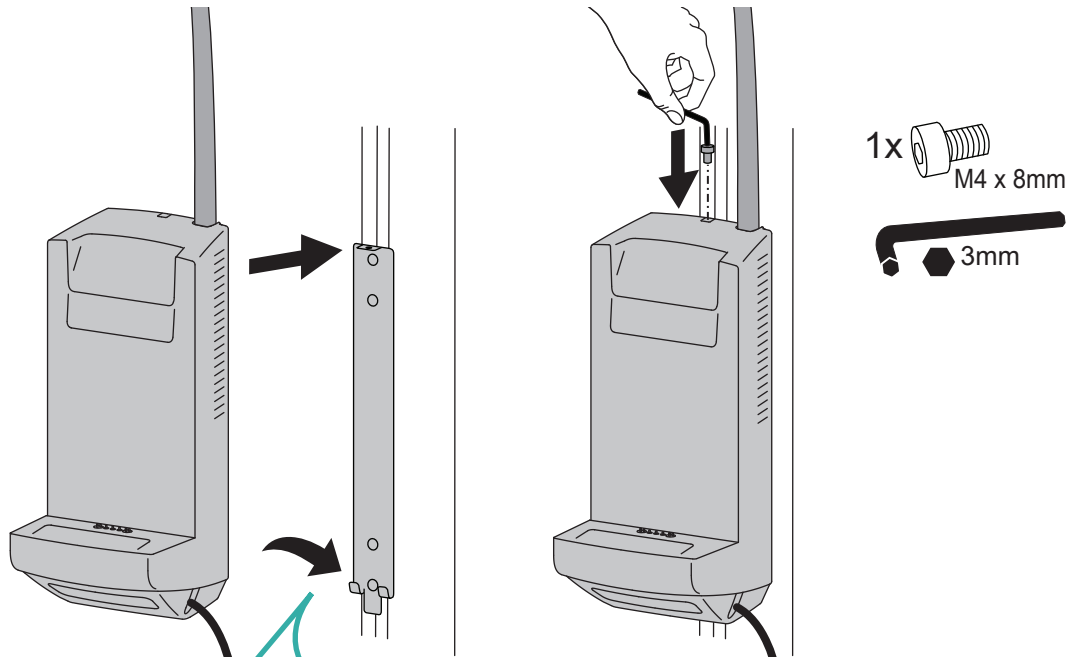

The Power Module sets onto the bottom hooks and then lift slightly to align the upper tab on the bracket with the hole where the screw is then secured

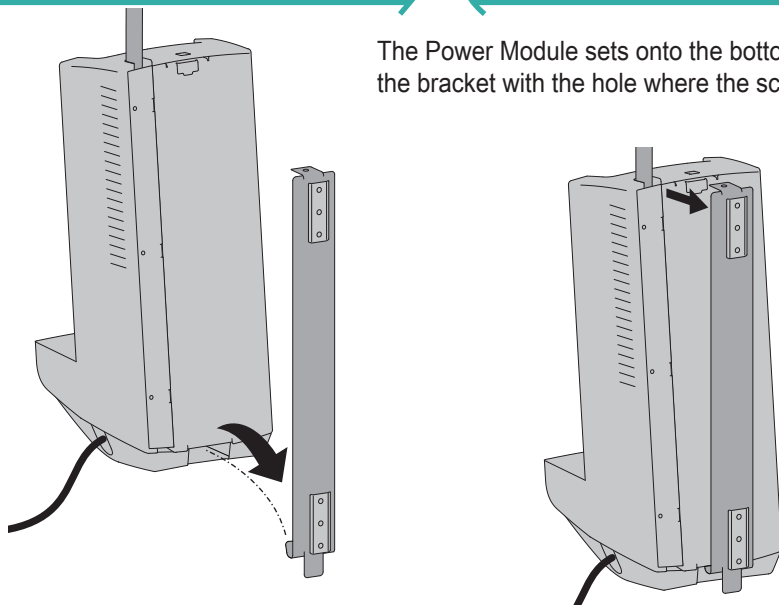

11

1

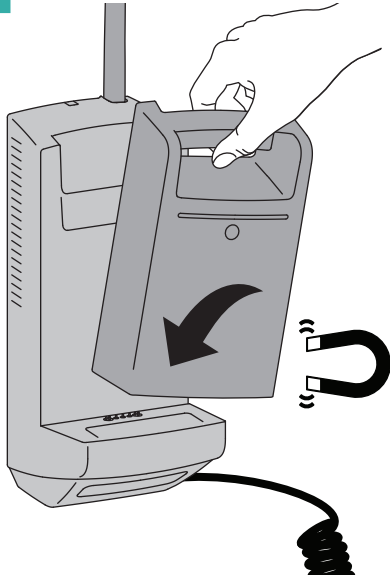

2

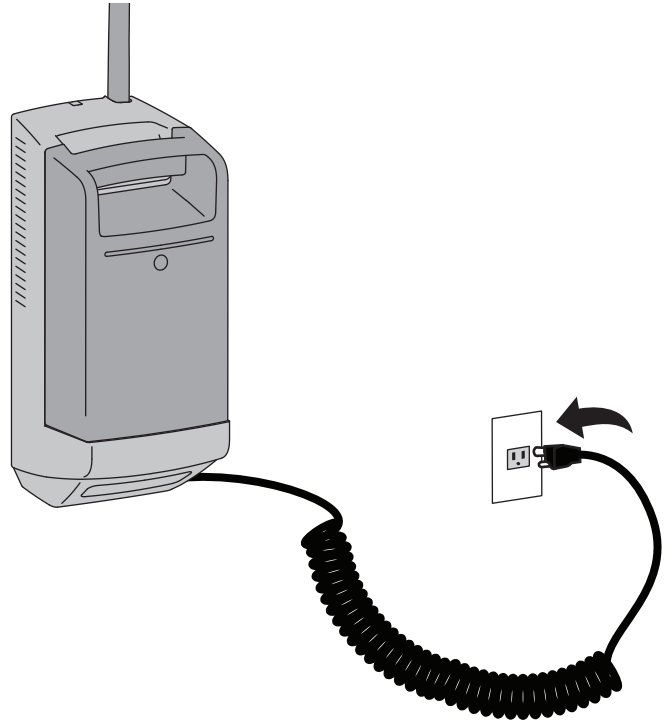

3 Display

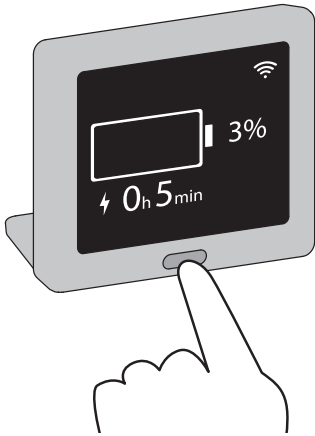

Push button to turn on.
DISPLAY MUST BE TURNED ON FOR BATTERY TO CHARGE.

Dock the Battery by placing on the Power Module. (Battery Sold Separately.)
Do not drop Battery on Power Module. When Battery is properly docked, the Battery's fuel gauge will light for 3 seconds. If Battery is not properly docked, do not push on Battery. Remove Battery and repeat docking.
To charge Battery: plug Power Module into wall outlet and turn on Display.
DISPLAY MUST BE TURNED ON FOR BATTERY TO CHARGE.

To Remove Battery, squeeze handle and pull off.

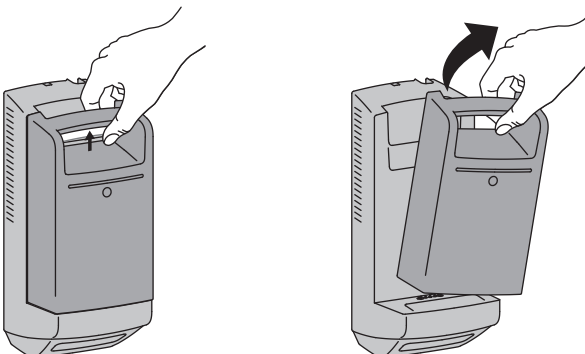

Once the Battery is removed, Power Module will continue to supply power to devices for 2 minutes. To avoid losing power to devices, ensure that a charged battery is replaced on Power Module or unit is plugged into AC power.

Display

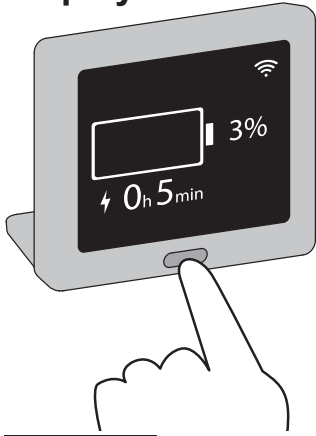

The Display shows battery capacity both in percentage and operational time remaining. The time remaining is calculated based on average actual load. This information is to be used to determine when to swap with a charged battery or to plug in Power Module.

Push button to turn on.

Display will automatically dim after 1 min, press button once to brighten display. To turn off, push and hold button until screen turns off.

DISPLAY MUST BE TURNED ON FOR BATTERY TO CHARGE.



RED plug: Not Charging and time to fully discharged is less than 5 minutes



RED Bar: State of charge is greater than 5% and less than or equal to 10%



RED Bars: State of charge is greater than 10% and less than or equal to 20%



YELLOW Bars: State of charge is greater than 20% and less than or equal to 30%



GREEN Bars: State of charge is greater than 30% and less than or equal to 50%



GREEN Bars: State of charge is greater than 50% and less than or equal to 70%



GREEN Bars: State of charge is greater than 70% and less than or equal to 90%



GREEN Bars: State of charge is greater than 90%



RED: Error status.

Reference troubleshooting guide: <https://www.ergotron.com/en-us/support/software/ekinnex-for-lifekinnex> or contact Ergotron Customer Care for assistance.



Wifi status. This symbol will blink to notify user that Wifi needs to be configured.

Instructions on connecting device to Wi-Fi network can be found at <https://www.ergotron.com/en-us/support/software/ekinnex-for-lifekinnex>

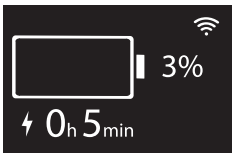

During charging, LCD shows charging symbol with time remaining on battery.



GREEN Bars: In battery mode, LCD shows time for battery run time

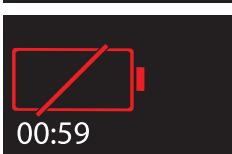

RED Battery: 2-minute countdown timer when battery is removed.



Power cord is plugged into an AC outlet and there is no battery on the unit.

OPERATING MODE	OPERATION DETAILS
AC supply mode	By connecting to AC power source, the Power Module will use the AC power to support both charging and output loading. The swappable battery pack and the backup battery will be charged to full when AC power is connected. The charging current depends upon the output loading. The remaining power will be used to charge the battery.
Battery supply mode	The Power Module will work as a battery to provide continuous AC output to varying loads. The swappable battery pack will also charge the backup battery on the Power Module to make sure backup battery capacity is enough to handle the swapping. During the swapping, the display will show a 2 minute countdown and after 2 minutes, power will no longer be provided to devices. In the event that battery fully depletes before AC power is supplied or battery pack is replaced with a charged battery pack, the Power Module will shut down and power will no longer be provided to devices.
Standby mode	Power Module will enter standby mode when button on the display is pressed for more than 3 seconds. No charging activity during this mode. AC output / Inverter shuts down. Power Module enters low power mode. To return back to operating mode, simply press the display button.
Shut down mode	For Power Module to enter shut down mode, both battery and AC power source must be removed. To force the shut down mode, unplug the AC power source, remove the battery, then power off the Power Module by holding the Display button for 3 seconds. Alternatively, the Power Module will automatically enter shut down mode if the Battery is removed and no new battery is placed on the Power Module. The Display will show a 2 minute count down, after which power will no longer be provided to devices. The Display screen will then shut off and the system will shut down. To return back to operating mode, place a battery on the Power Module or connect AC power source to the Power Module and press the display button.

SERVICE AND MAINTENANCE

The Power Module shall be installed and repaired by qualified personnel only.

The cleaning and preventive inspection should be performed by individuals with previous training.

Prior to cleaning or storing the Power Module for extended periods, the system should be placed in shut down mode. To do this, unplug the AC power source, remove battery, then power off the Power Module by holding the Display button for 3 seconds.

Cleaning methods include:

Use a vacuum to clean out the dust from the opening of the fan and contact pin of the power bay.

Dampen cloth with water or cidex solution to clean the surface.

Do not use any alcohol or ammonia based solution to clean the surface.

Avoid spilling liquid into or on the Power Module.

When not using the battery for long periods, battery should be fully charged before storage and charged regularly during storage.

Keep spring pin contacts free of dust and debris.



EQUIPMENT & ACCESSORIES DISPOSAL

1. Please dispose of or recycle all batteries in accordance with local law
2. All Electronics should be recycled through an electronics recycler.
3. Remaining plastics and metals can be recycled through a commercial recycler.

ERGOTRON ELECTROMAGNETIC GUIDANCE AND MANUFACTURER'S DECLARATION

Guidance and Manufacturer's Declaration – Electromagnetic Emissions		
The Power Module is intended for use in the electromagnetic environment specified below. The customer or the user of the Power Module should assure that it is used in such an environment.		
Emissions Test	Compliance	Electromagnetic environment – guidance
RF Emissions CISPR 11	Group 1	The Power Module uses RF energy only for its internal function. Therefore, its RF emissions are very low and unlikely to cause any interference in nearby electronic equipment.
RF Emissions CISPR 11	Class A	The Power Module is suitable for use in all establishments other than domestic and those directly connected to the public low-voltage power supply network that supplies buildings used for domestic purposes.
Harmonic Emissions IEC 61000-3-2	Class A	
Voltage fluctuations/ flicker emissions IEC 61000-3-3	Complies	

Guidance and Manufacturer's Declaration – Electromagnetic Immunity			
The Power Module is intended for use in the electromagnetic environment specified below. The customer or the user of the Power Module should assure that it is used in such an environment.			
Immunity Test	IEC 60601 Test Level	Compliance Level	Electromagnetic environment - guidance
Electrostatic Discharge (ESD) IEC 61000-4-2	±8 kV contact ±15 kV air	Complies	Floors should be wood, concrete, or ceramic tile. If floors are covered with synthetic material, the relative humidity should be at least 30%
Radiated RF EM fields IEC 61000-4-3	10V/m 80 MHz – 2.7 GHz	complies	
Radiated RF EM fields: Proximity fields from RF wireless communications equipment IEC 61000-4-3	IEC 60601-1-2:2014 table 9	complies	WARNING: Portable RF communications equipment (including peripherals such as antenna cables and external antennas) should be used no closer than 30 cm (12 inches) to any part of LifeKinnex Power Module, including cables specified by the manufacturer. Otherwise, degradation of the performance of this equipment could result.
Electrical Fast Transient/Burst IEC 61000-4-4	±2 kV for power supply lines	Complies	Mains power quality should be that of a typical commercial or hospital environment.
Surge IEC 61000-4-5	±1 kV differential mode ±2 kV common mode	Complies	Mains power quality should be that of a typical commercial or hospital environment
Conducted Immunity IEC 61000-4-6	3 V rms 0.15 MHz – 80 MHz 6 V rms (ISM) 80 % AM at 1 kHz	complies	
Voltage Dips, short interruptions, and voltage variations on power supply input lines IEC 61000-4-11	0% Ut for 0.5 cycle 70% Ut for 25 cycles 0% Ut for 5 seconds	Complies	Mains power quality should be that of a typical commercial or hospital environment.
Power Frequency (50/60 Hz) Magnetic Field IEC 61000-4-8	30 A/m	Complies	Power frequency magnetic fields should be at levels characteristic of a typical location in a typical commercial or hospital environment.
Note: U_T is the AC mains voltage prior to application of the test level			

POWER MODULE INTERFACE:

1. RJ55: Connect Display Module (916-339) to this connector
2. Reset: Reset button to reset the whole system
3. USB : USB Connector for configuration
4. AC IN 100V ~ 240V: Connect AC input coiled cord here
5. AC OUT: Connect AC output cable module here

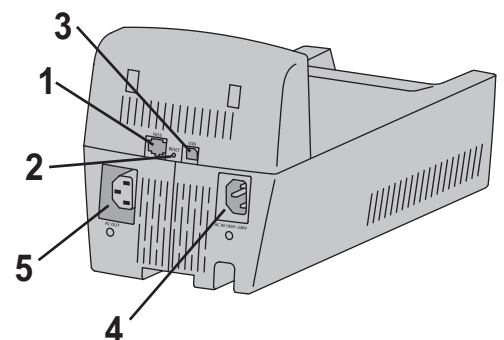

For Warranty visit: www.ergotron.com/warranty

For Service visit: www.ergotron.com

For local customer care phone numbers visit: <http://contact.ergotron.com>

NOTE: When contacting customer service, reference the serial number.

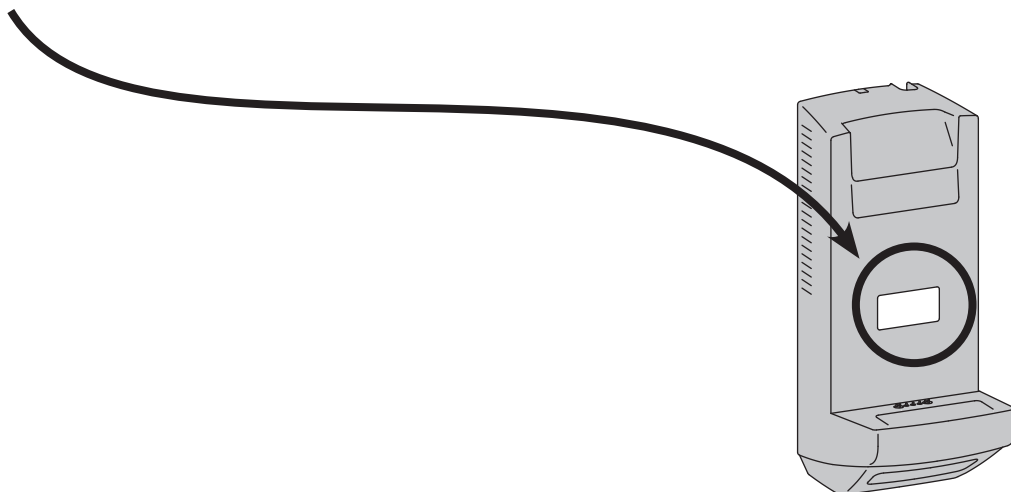

ergotron®

www.ergotron.com | USA: 1-800-888-8458 | Europe: +31 (0)33-45 45 600 | China: 400-120-3051 | Japan: japansupport@ergotron.com

© 2018 Ergotron, Inc. All rights reserved. Manufactured for Ergotron by Green Cubes Technology www.greencubestech.com.
LiFeKinnex™ is a registered trademark of Ergotron, Inc.

While Ergotron, Inc. makes every effort to provide accurate and complete information on the installation and use of its products, it will not be held liable for any editorial errors or omissions (including those made in the process of translation from English to another language), or for incidental, special or consequential damages of any nature resulting from furnishing this instruction and performance of equipment in connection with this instruction. Ergotron, Inc. reserves the right to make changes in the product design and/or product documentation without notification to its users. For the most current product information, or to know if this document is available in languages other than those herein, please contact Ergotron. No part of this publication may be reproduced, stored in a retrieval system, or transmitted in any form or by any means, electronic, mechanical, photocopying, recording or otherwise without the prior written consent of Ergotron, Inc., 1181 Trapp Road, Eagan, Minnesota, 55121, USA. Patents Pending and Patented U.S. & Foreign. Ergotron is a registered trademark of Ergotron, Inc.