

---

# INSTRUCTION MANUAL

---

## Truss Pitch-Adjustable (TPP) Mount

The Truss Pitch-Adjustable (TPP) mount is a perfect solution exhibit, retail and digital signage applications. The mount is quick, easy and versatile.

The TPP accommodates a large range of truss dimensions (up to 14" O.D.), includes security options and provides flexible feature to achieve a custom installation installation. The exclusive Q-Latch™ Mounting System secures the LArge Flat Panel Display with a lockable latch to confirm mount stability and integrated security allows the display to be locked to the mount by adding a padlock.

Your display can be mounted portrait or landscape and four pitch adjustments, up or down, are available as pre-set, locking positions (0, 5, 10 or 15 degrees).

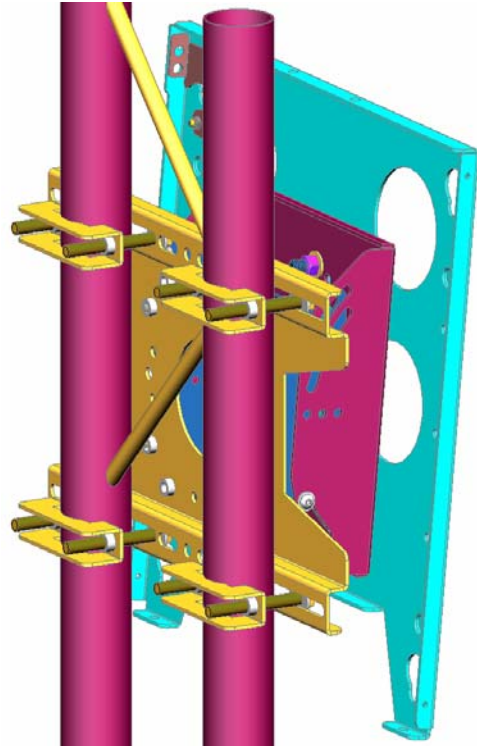

### BEFORE YOU BEGIN

---

- **WARNING: TO PREVENT PERSONAL INJURY, THOROUGHLY STUDY ALL INSTRUCTIONS AND ILLUSTRATIONS BEFORE YOU BEGIN TO INSTALL THE UNIT. PAY PARTICULAR ATTENTION TO THE "IMPORTANT WARNINGS AND CAUTIONS" ON PAGE 1.**
- **CAUTION: To prevent damage to the mount, which could affect or void the Factory warranty, thoroughly study all instructions and illustrations before you begin to install the unit. Pay particular attention to the "IMPORTANT WARNINGS AND CAUTIONS" on Page 1.**
- The maximum weight to be installed on the TPP is 150 pounds (68.04 Kg).
- If you have any questions about this assembly, contact Chief Manufacturing at 1-800-582-6480 or 952-582-6480.



**CHIEF MANUFACTURING INC.**  
1-800-582-6480 952-894-6280 FAX 952-894-6918  
8401 EAGLE CREEK PARKWAY  
SAVAGE, MINNESOTA 55378 USA

PART NO. 8804-000010 (Rev. B)  
©2003 Chief Manufacturing  
[www.chiefmfg.com](http://www.chiefmfg.com)  
Printed in USA 05-04



## IMPORTANT WARNINGS AND CAUTIONS!

- **WARNING:** A **WARNING** alerts you to the possibility of serious injury or death if you do not follow the instructions.
- **CAUTION:** A **CAUTION** alerts you to the possibility of damage or destruction of equipment if you do not follow the corresponding instructions.
- **WARNING:** **Improper installation can result in serious personal injury! Make sure that the structural members can support a redundant weight factor five times the total weight of the equipment. If the structural members can not support this weight, reinforce the structural members before installing the mount.**
- **WARNING:** **The installer is responsible for verifying that the structure to which the TPP is anchored will safely support the combined load of all attached components or other equipment.**
- **WARNING:** **The weight of the display must not exceed 150 lbs. (68.04 kg), the maximum load capacity of the TPP.**
- **WARNING:** **Be aware during the installation that there are no pinch points for people and for electrical wiring.**
- **WARNING:** **Be aware of the potential for personal injury or damage to the mount if it is not adequately mounted.**
- **CAUTION:** Check the unit for shipping damage before you begin the installation.
- **CAUTION:** Changes or modifications not approved by Chief Manufacturing could void user’s warranty.

## TOOLS REQUIRED FOR INSTALLATION

- Socket set with extension
- Open wrenches

NOTE: Other tools may be required depending on the method of installing the lift in the ceiling.

## CONTENTS

PARTS .....	2
INSPECT THE MOUNT BEFORE INSTALLING .....	3
TPP INSTALLATION .....	3
Assembly .....	3
Mount the Display .....	5
Tilt Adjustment .....	5
Remove the Display .....	6

- |                                       |  |
|---------------------------------------|--|
| (1) PLATE, back                       | (1) SCREW, pan head, 10-24               |
| (1) PLATE, assembly, pitch-adjustable | (4) SCREW, cap, hex head, 5/16-18 X 1/2" |
| (1) PLATE, face                       | (2) NUT, Stover locknut, 3/8-16          |
| (1) FLAG, latching                    | (1) SPACER, Nylon, .38 X .194 X .032"    |
| (1) NUT, Nylock, 10-24                | (2) WASHER, flat, 3/8"                   |
|                                       | (3) WASHER, VHMW                         |

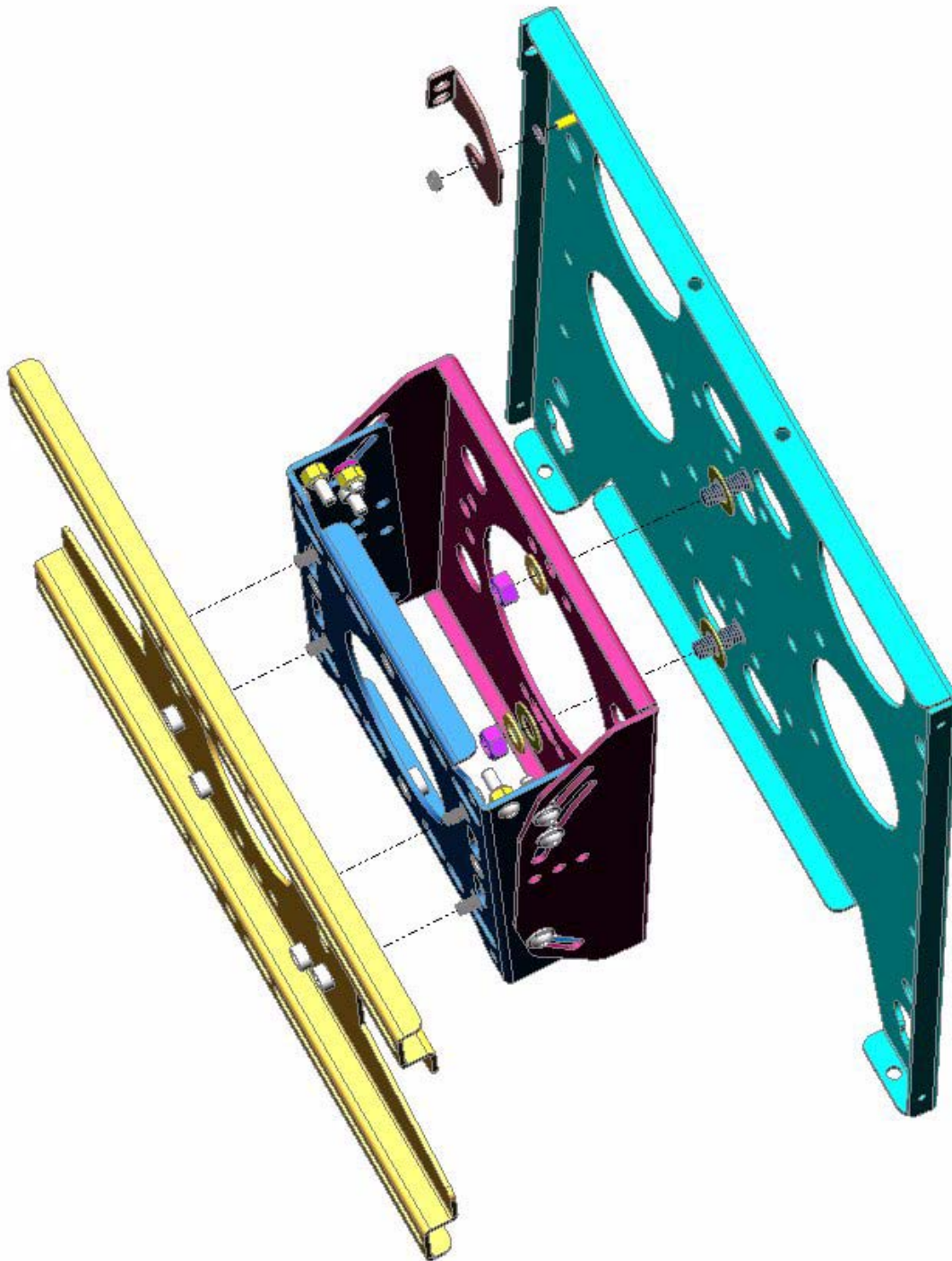

## PARTS

## INSPECT THE MOUNT BEFORE INSTALLING

**IMPORTANT:** Before installing the mount, make sure it has not been damaged during shipping.

1. Carefully inspect the mount for shipping damage. If any damage is apparent, call your carrier claims agent and do not continue with the installation of the mount until the carrier has reviewed the damage.

## TPP INSTALLATION

### Assembly

1. Install the Nylon spacer on the stud in the corner of the face plate (see Figure 1).
2. Install the latching flag over the Nylon spacer.
3. Secure the latching flag to the face plate using the 1/4-20 Nylock nut loose enough to move but tight enough to remain in place when raised.

**WARNING:** It is the responsibility of the installer to verify that the structure to which the TPP is anchored will safely support the combined load of all attached components and equipment.

4. Securely anchor the back plate to the framework using Chief TPK accessory clamps or equivalent rated fasteners for the required load (see Figure 2).
5. Install the pitch-adjustable plate on the back plate and secure using four 5/16-18 X 1/2" hex head cap screws (see Figure 3).

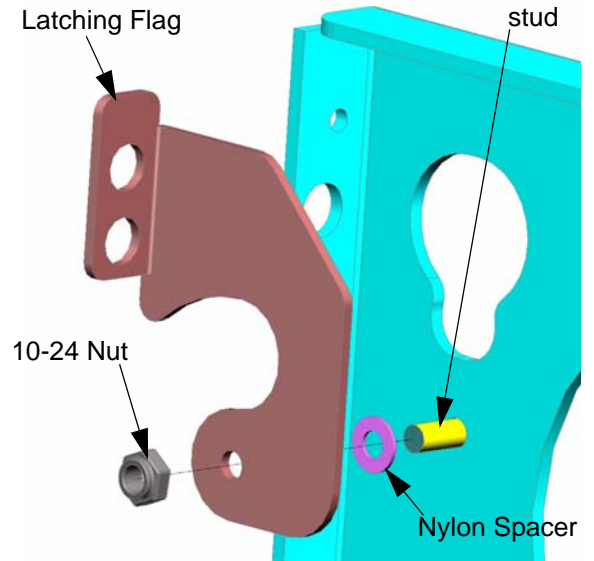

Figure 1. Install Flag

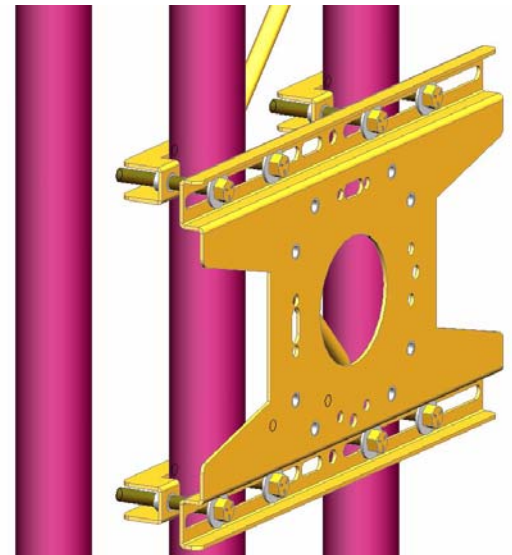

Figure 2. Anchor Back Plate

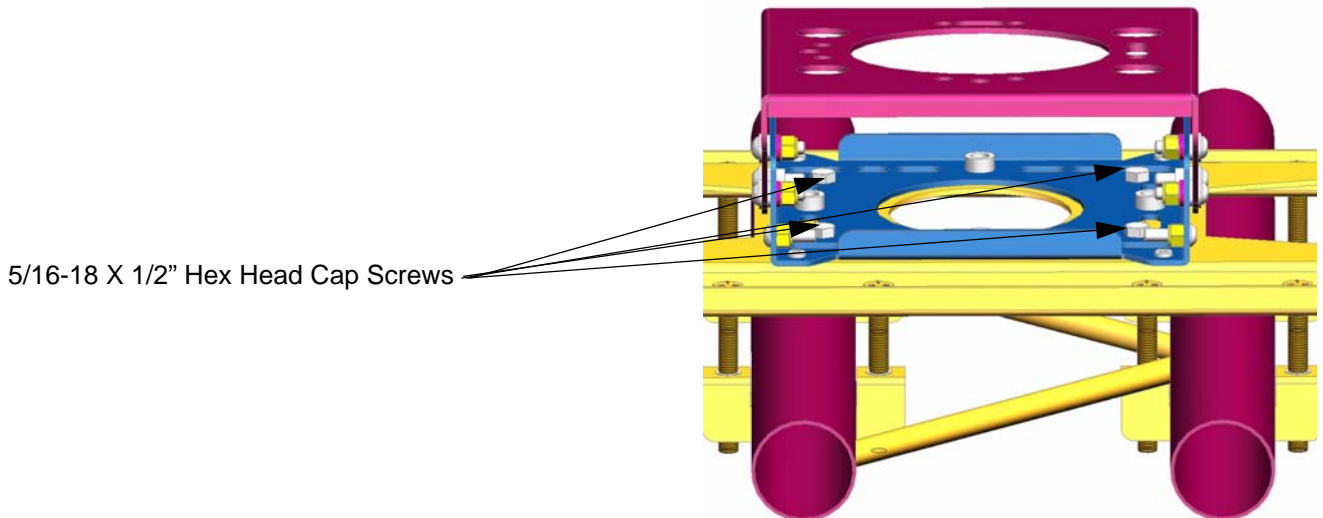

Figure 3. Pitch-Adjustable Plate to Back Plate

6. Install the face plate in the desired position (see Figure 4, Figure 5, Figure 6 and Figure 7) on the pitch-adjustable plate and secure using two 3/8-16 Nylock nuts and washers in any matching set of radial holes slotted to allow slight roll adjustment.

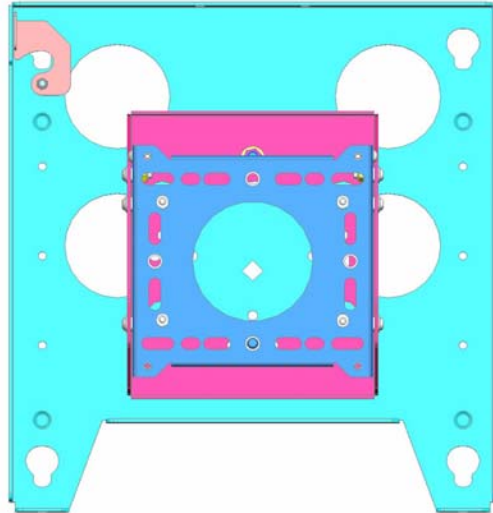

Figure 4. Vertical Tilt Shown without Back Plate for Clarity

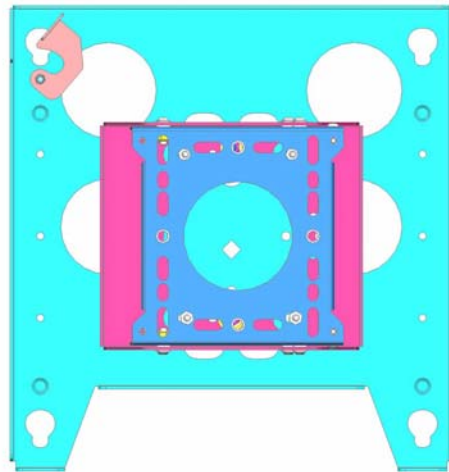

Figure 5. Horizontal Tilt Shown without Back Plate for Clarity

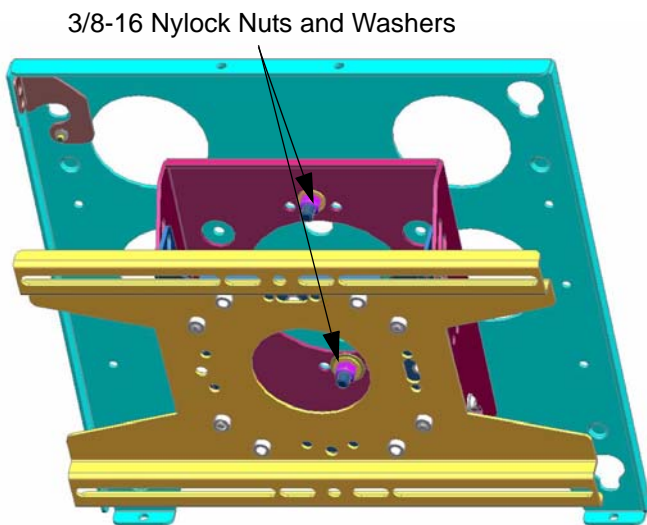

Figure 6. Vertical Truss Shown with Back Plate

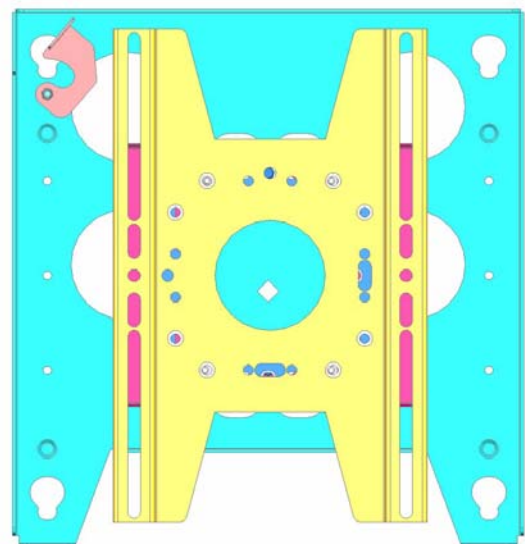

Figure 7. Horizontal Truss Shown with Back Plate



Mount the Display

1. Attach included PSB brackets to your display using the instructions included with the PSB package.
2. Make sure no power is supplied to the display and the flag is in the down position before attempting to mount the display.
3. Using two people, slide the display down over the four slots in the face plate of the TPP. Make sure all four Quick Latches (Q-Latches) of the display engage all four slots in the TPP.

**WARNING: Make sure the flag securing the display is completely raised at all times except when removing or installing the display. The flag must be all the way up when installing/removing cables.**

4. With the Q-Latches of the display fully engaged in the slots of the TPP, secure the display on the TPP by raising the flag all the way up to the locked position (see Figure 8). *If the flag does not fully engage, remove the display and make sure the brackets are correctly installed.*

NOTE: A security lock may be installed through the hole in the flag for additional security.

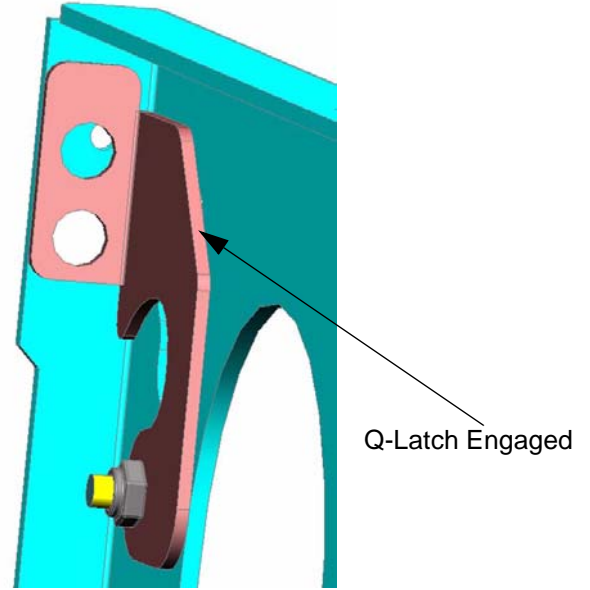

Figure 8. Engage Q-Latch

Tilt Adjustment

**WARNING: Watch for pinch points. Do not put your fingers between movable parts.**

1. Loosen tilt adjustment screws, adjust to desired tilt, and tighten tilt adjustment screws if necessary (see Figure 9).
2. Loosen tilt adjustment screws, adjust to desired tilt, and tighten tilt adjustment screws if necessary (see Figure 10, Figure 11, and Figure 12).

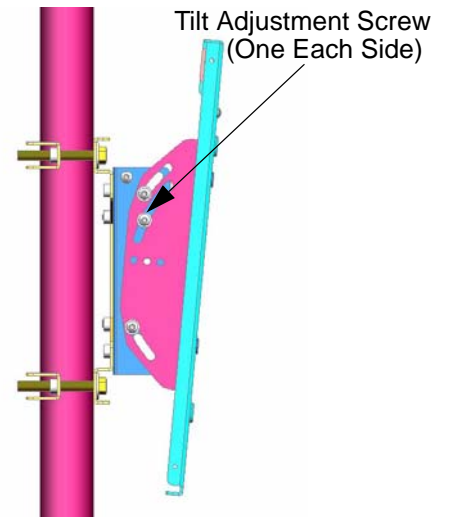

Figure 9. Tilt Adjustment Screw Location

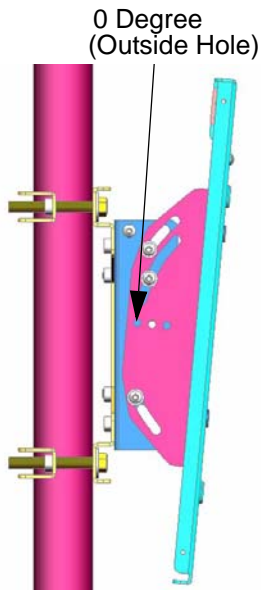

Figure 10. 0 Degree Tilt

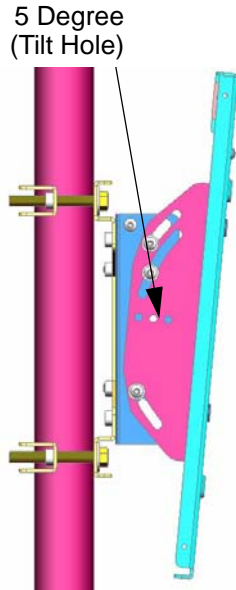

Figure 11. 5 Degree Tilt

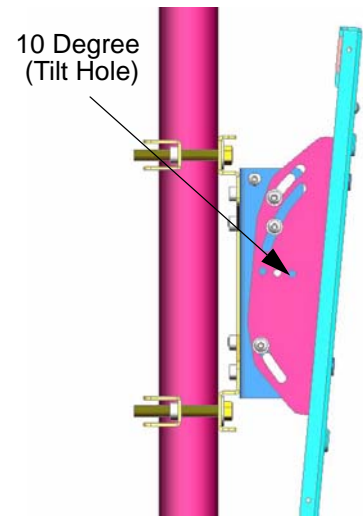

Figure 12. 10 Degree Tilt

## Remove the Display

**WARNING:** Make sure the flag securing the display is completely raised at all times except when removing or installing the display. The flag must be all the way up when installing/removing cables.

**WARNING:** Watch for pinch points. Do not put your fingers between movable parts.

1. Unlock the display from the TPP by lowering the flag all the way down to the unlocked position.
4. Using two people, slide the display up and out of the TPP.