

THE PERFECT BLEND OF STYLE AND FUNCTIONALITY

Workrite's workcenter accessory program provides complete solutions for outfitting the modern workcenter.

Select from a wide variety of options for use above the worksurface including tool rails, privacy panels, document holders and above desk power centers, all designed to help create more ergonomic workspaces that allow users to work comfortably and efficiently throughout the day.

Workrite's accessory products are not only compatible with our adjustable height workcenters, they can also be used with many of the most popular furniture systems and other adjustable height workstations in the market today.



The Sierra Privacy Panel includes frosted acrylic panels.



The Above-Desk Power/Data Supply is ideal for 24" deep workcenters.

WORKCENTER ACCESSORIES—ABOVE DESK

WORKCENTER ACCESSORIES

Above Desk Accessories

Tool Bar

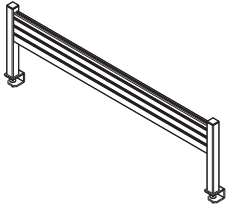

- Quickly and securely clamp mounts to worksurfaces .5" to 1.25" thick using an Allen key (provided)
- Features 5.75" two sided extruded aluminum tool bar panel with three slots for attaching organization and storage accessories
- Available in silver or charcoal finish
- See Quick Reference Chart on the next page to determine best size and model number for specific applications

Model #		Width
Charcoal	Silver	
970-22-C	970-22-S	24.5"
970-28-C	970-28-S	27.5"
970-34-C	970-34-S	30.5"
970-40-C	970-40-S	36.5"
970-46-C	970-46-S	42.5"
970-52-C	970-52-S	48.5"
970-58-C	970-58-S	54.5"
970-64-C	970-64-S	60.5"
970-70-C	970-70-S	66.5"

Privacy Panel

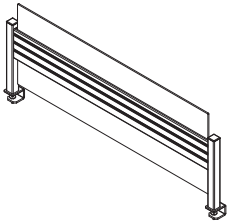

- This tool bar features 5" high frosted acrylic panels mounted above and below the tool bar panel to provide additional privacy
- Quickly and securely clamp mounts to worksurfaces .5" to 1.25" thick using an Allen key (provided)
- Features 5.75" two sided extruded aluminum tool bar panel with three slots for attaching organization and storage accessories
- Available in silver or charcoal finish
- See the Fit Chart on the next page to determine best size and model number for specific applications

Model #		Width
Charcoal	Silver	
971-22-C	971-22-S	24.5"
971-28-C	971-28-S	27.5"
971-31-C	971-31-S	36.5"
971-34-C	971-34-S	30.5"
971-40-C	971-40-S	36.5"
971-46-C	971-46-S	42.5"
971-52-C	971-52-S	48.5"
971-58-C	971-58-S	54.5"
971-64-C	971-64-S	60.5"
971-70-C	971-70-S	66.5"

Dimensions

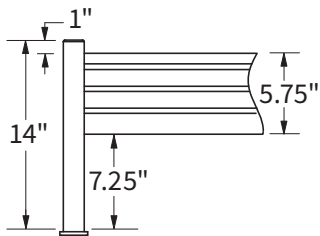

Tool Bar
Front view

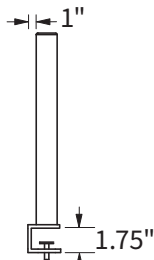

Side view

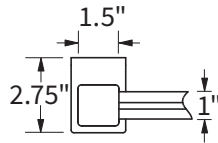

Top view

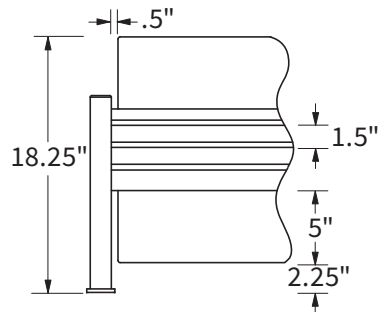

Privacy Panel
Front view

WORKCENTER ACCESSORIES—ABOVE DESK

Tool Bar & Privacy Panel Fit Chart

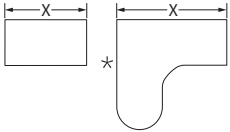
Workcenters*	Actual Worksurface Width						
	34"	40"	46"	52"	58"	64"	70"
Tool Bar Model #	970-34	970-40	970-46	970-52	970-58	970-64	970-70
Privacy Panel Model #	971-34	971-40	971-46	971-52	971-58	971-64	971-70
							

Small Equal Corner and 120 Degree Workcenters Only

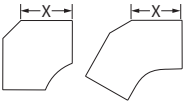
Tool Bar Model #	970-22	970-28	970-34	n/a	n/a	n/a	n/a
Privacy Panel Model #	971-22	971-28	971-34	n/a	n/a	n/a	n/a
							

Fit chart assumes outer edge of tool bar post is mounted 2.5" from outer edge of worksurface.
 ★ Rounded sides of Peninsula and P Peninsula worksurfaces not recommended.

Tool Bar & Privacy Panel Tools

Pen Holder



- Holds pens and pencils
- Mounts to Privacy Panel and Tool Bar
- 4"W × 4"H × 3.5"L
- Available in black or silver

Color **Model #**

Black 95204-B

Silver 95204-S

Shelf



- Holds small items like photos, stapler, memo pads
- Mounts to Privacy Panel and Tool Bar
- Available in black
- Short shelf: 18"W × 3.25"H × 7"L; 6 lb. weight limit
- Long shelf: 30"W × 3.25"H × 7"L; 10 lb. weight limit

Length **Color** **Model #**

Short shelf Black 95213-B

Long shelf Black 95214-B

Folder Tray



- File storage with dividers for easy access to working files
- Mounts to Privacy Panel and Tool Bar
- Available in black or silver
- 7"W × 2.5"H × 12.5"L; 6 lb. weight limit

Black 95210-B

Silver 95210-S

Legal Size Paper Tray

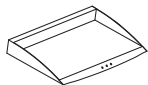

- Holds paper, notebooks, file folders, etc.
- Mounts to Privacy Panel and Tool Bar
- Available in black or silver
- 15"W × 2"H × 10.5"L; 6 lb. weight limit

Black 95207-B

Silver 95207-S

Accessory Tray

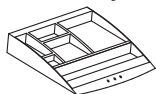

- Ideal for storage of small items such as clips, pins, pens, pencils and small pads
- Mounts to Privacy Panel and Tool Bar
- Available in black or silver
- 9.5"W × 2"H × 10"L

Black 95208-B

Silver 95208-S

WORKCENTER ACCESSORIES—ABOVE DESK

Products listed on this page are available through GSA Contract GS-28F-0030S SIN #711-2 (Schedule 71)

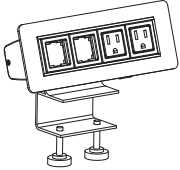

		Color	Model #
	<ul style="list-style-type: none"> • Configured with two voice/data openings and two power outlets • Clamps on back edge, above worksurface • Ideal for use with any Workrite laminated worksurface • Aluminum construction, in silver with black power/data receptacles • 10', 15 Amp cord; UL listed • Voice/Data Adapters provided, see below: 	Silver	95302-S

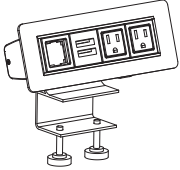
		Color	Model #
	<ul style="list-style-type: none"> • Configured with two powered USB ports, one voice/data opening and two power outlets • Clamps on back edge, above worksurface • Ideal for use with any Workrite laminated worksurface • Aluminum construction, in silver with black power/data receptacles • 10', 15 Amp cord; UL listed • Voice/Data Adapters provided for the following: <ul style="list-style-type: none"> • Allen Tel Versa Tap Series • Hubbell Xcelerator Keystone Series • Krone 6000 Series • L-Com Keystone Modular • Leviton Quick Port® Series • Uniprise • Microphone jack/3-pin XLR, solder type only • Nordx Keystone Style • Ortronics TracJack Series • Panduit Mini-Com Series • Seimon Keystone Style • Systemax • Tyco SL and 110 Connect Series Modular Jacks • Tyco SL Coupler Series • Video Monitor jack/DB-15, panel mount solder type <p><i>Note: Data port installation is responsibility of end user</i></p>	Silver	95304-S

		Width	Model #
	<ul style="list-style-type: none"> • Solid construction and design supports multiple documents, binders, catalogs and manuals • Slotted angle style adjusts from 42° to 82° • 5.375" height adjustability keeps documents from blocking the view of the monitor • Fasteners included, ships fully assembled 	11"	2550B
		17"	2560B

		Model #
	<ul style="list-style-type: none"> • Lightweight and portable ergonomic support for laptop computers • Elevates screen up to 6" for improved head and shoulder posture • Adjusting bar moves forward and back to change platform tilt from 10° to 30° for neutral positioning of hands and wrists • Includes black memory foam palm support 	UB2400-25J