

MODEL 8312

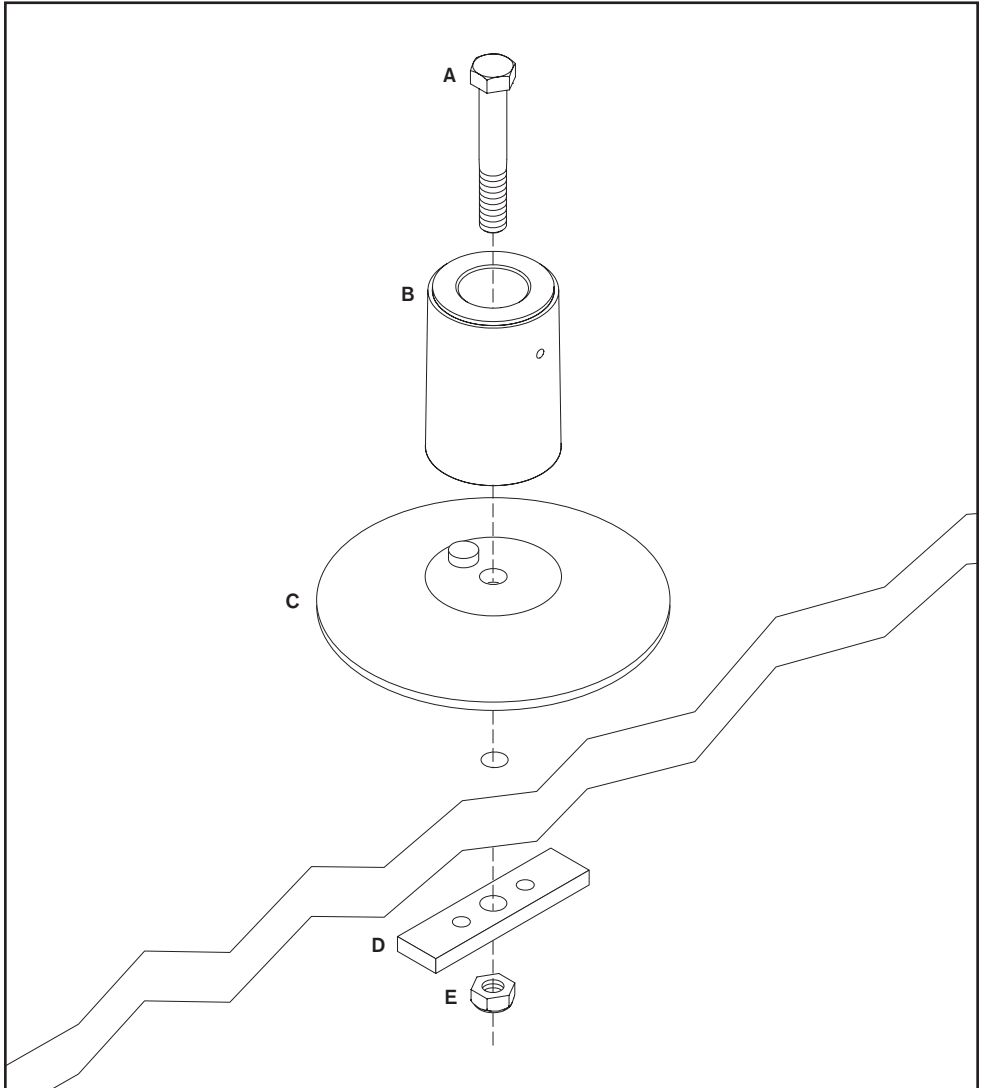

Installation Instructions

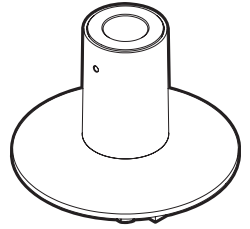

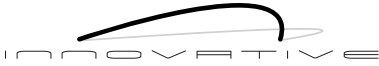

MODEL 8312

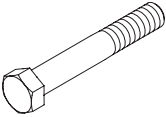
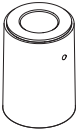
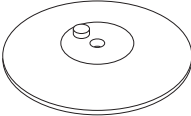
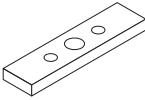
Installation Instructions

ITEM	DESCRIPTION / PART NO.	QUANTITY
A 	3/8-16 x 2-1/2" Hex Head Bolt 700268	1
B 	Mount Column 704064	1
C 	Base Plate 704063	1
D 	Rectangular Spacer 701544	1
E 	3/8-16 Nylon Stop Nut 701418	1