

Installation and Assembly - Adapter Bracket for VESA® 600 x 600 Screens

Model: PLP-V6X6

IMPORTANT! Read instruction sheet before you start installation and assembly.

Before you start make sure all parts listed are included with your product.

Parts List

Description	Qty	Part #
A adapter bracket	1	202-1674
B 5/32" (4mm) allen wrench	1	560-9646
C 1/4" (6mm) allen wrench	1	560-9716
D M10 x 15 mm security socket pin screw	4	520-9262
E M6 x 20 mm serrated washer head socket pin screw	4	510-9554
F M6 x 12 mm serrated washer head socket pin screw	4	510-1050
G M8 x 25 mm security socket pin screw	4	520-1101
H spacer	4	540-1015
I #10 flat washer	4	540-9400

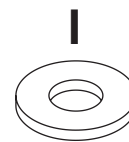
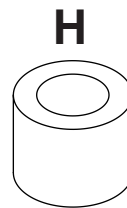
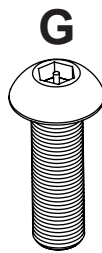
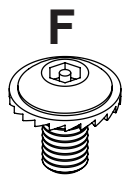
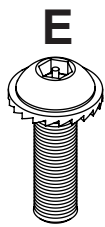
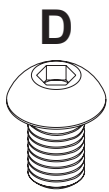
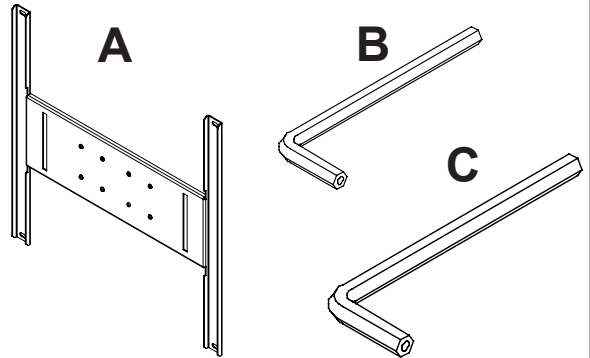

Some parts may appear slightly different than illustrated.

⚠ WARNING

- Do not overtighten. Overtightening may cause permanent damage to the screen. Torque to 26-35 in • lb (30-40 kg • cm).

- Begin with shortest length screw (**D**, **E**, **F** or **G**), hand thread through adapter plate into screen as shown below. Screw must make at least three full turns into screen insert and fit snug into place. Do not overtighten. If screw cannot make three full turns into screen insert, select a longer length screw. Repeat for remaining holes. If you have any questions, please call Peerless customer care at **1-800-865-2112**.

NOTE: Spacer (**H**) is only to be used with M8 x 25 mm socket pin screw (**G**). #10 washer (**I**) is used with M6 x 12 mm serrated washer head socket pin screw (**F**) only.

