

OMNILINK[®]

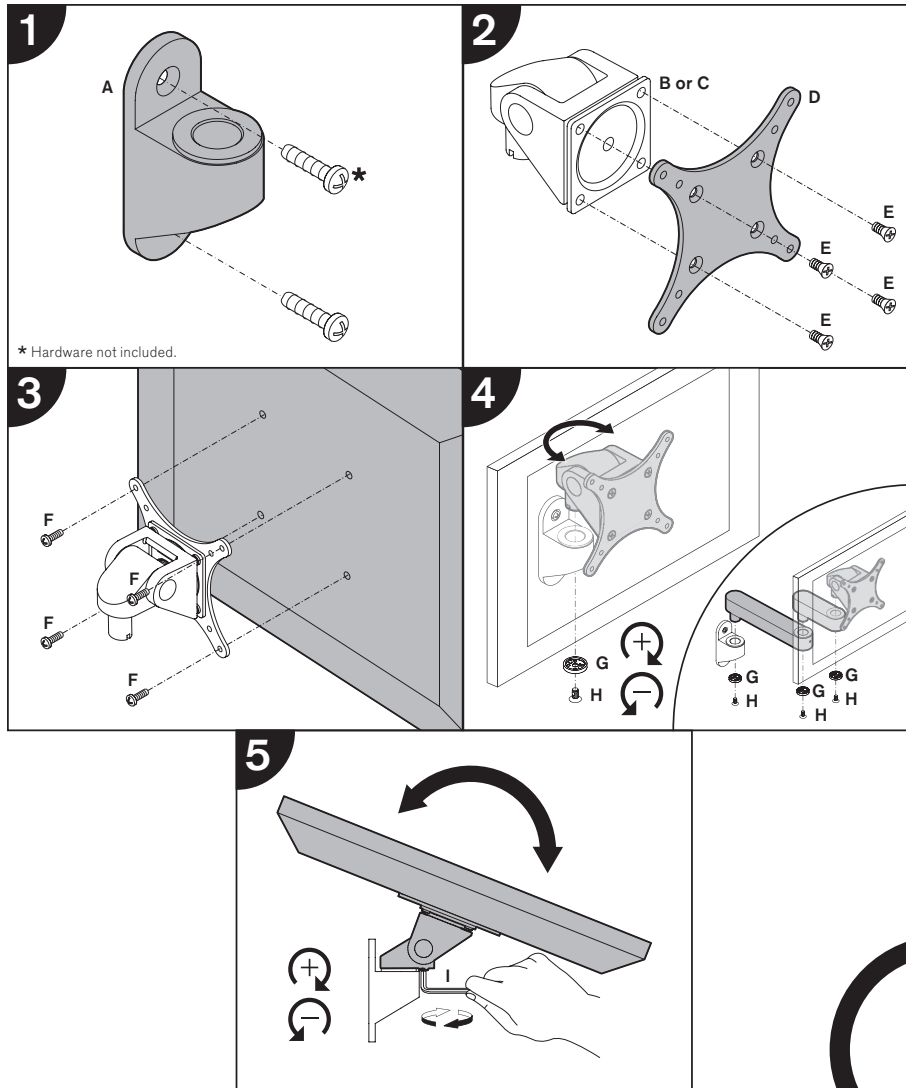

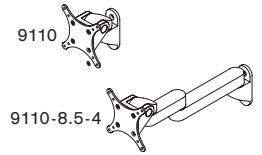



Installation Instructions

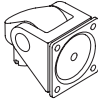
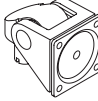

877.523.2767
www.ergotechgroup.com

OMNILINK®

Installation Part List

ITEM	DESCRIPTION / PART NO.	QUANTITY		
		9110	9110-4 & 9110-8.5	9110-8.5-4
A	 Wall Mount RP406795	1	1	1
B	 Monitor Tilter 405397	1	1	1
C	 Spring-Assisted Monitor Tilter (9110-HD only) 407747	1	1	1
D	 75mm/100mm VESA® Adapter Plate 105587	1	1	1
E	 10-32 x 3/8" Phillips Flat Head Screw 702281	1 (4-pack)	1 (4-pack)	1 (4-pack)
F	 M4-12 Phillips Pan Head Screw 702096	1 (4-pack)	1 (4-pack)	1 (4-pack)
G	 Dog Washer 105189	1	2	3
H	 10-32 x 3/8" FPhMS w/Lock Patch 705198	1	2	3
I	 7/32" Allen Wrench 701127	1	1	1