

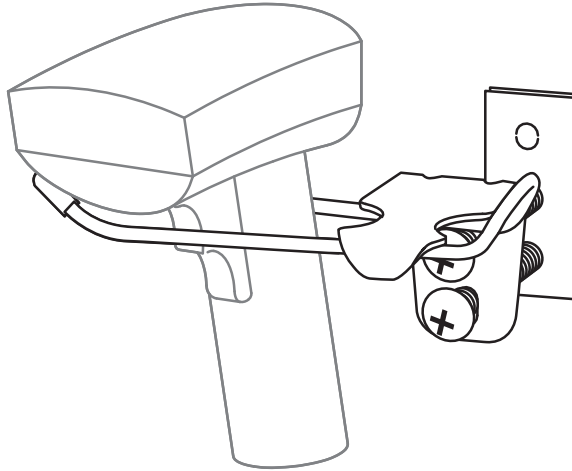

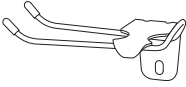

www.ergotron.com
 USA 1-800-888-8458
 Europe +31 (0)33-45 45 600
 China 86-769-86018920



	A	B	C
1	1x 	1x 	2x  M5 x 10mm

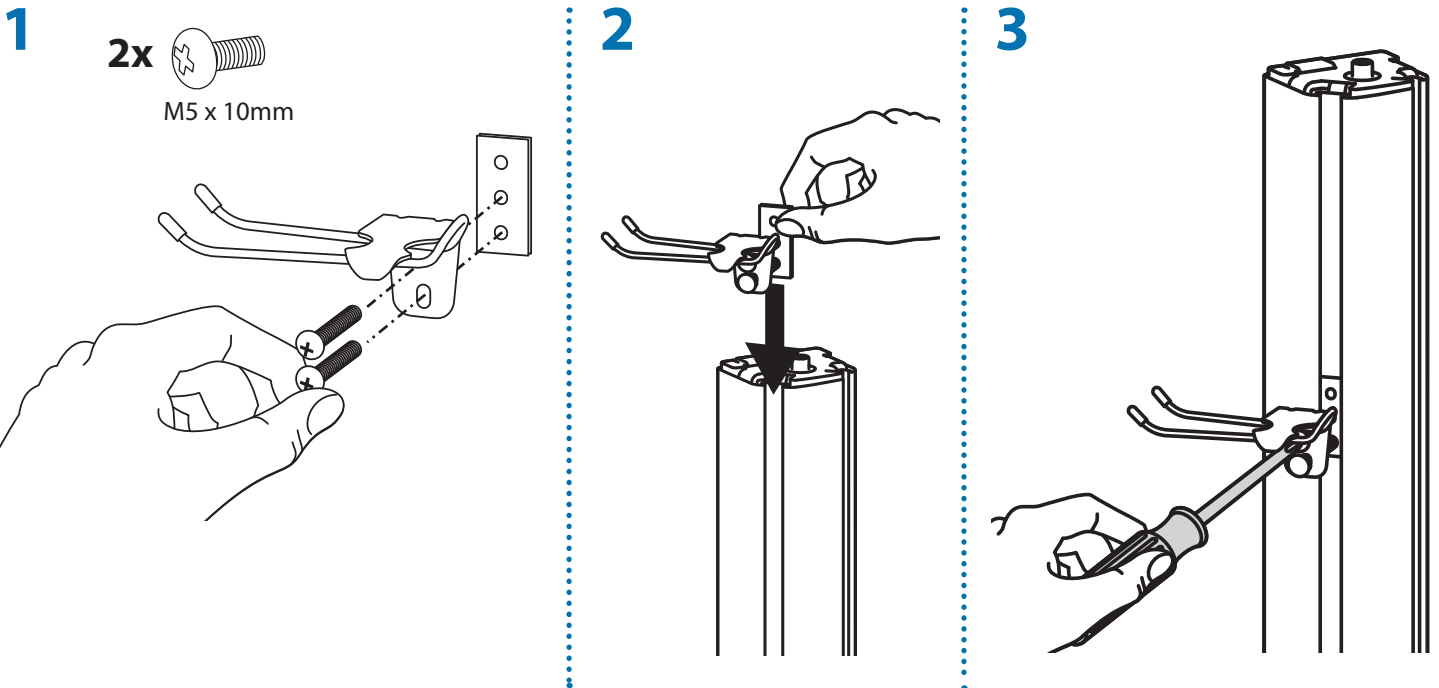
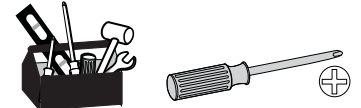

 © 2010 Ergotron, Inc. All rights reserved.

While Ergotron, Inc. makes every effort to provide accurate and complete information on the installation and use of its products, it will not be held liable for any editorial errors or omissions (including those made in the process of translation from English to another language), or for incidental, special or consequential damages of any nature resulting from furnishing this instruction and performance of equipment in connection with this instruction. Ergotron, Inc. reserves the right to make changes in the product design and/or product documentation without notification to its users. For the most current product information, or to know if this document is available in languages other than those herein, please contact Ergotron. No part of this publication may be reproduced, stored in a retrieval system, or transmitted in any form or by any means, electronic, mechanical, photocopying, recording or otherwise without the prior written consent of Ergotron, Inc., 1181 Trapp Road, Eagan, Minnesota, 55121, USA Patents Pending and Patented U.S. & Foreign. Ergotron is a registered trademark of Ergotron, Inc.

Americas Sales and Corporate Headquarters **EMEA Sales**
 St. Paul, MN USA Amersfoort, The Netherlands
 (800) 888-8458 +31 33 45 45 600
 +1-651-681-7600 www.ergotron.com
www.ergotron.com info.eu@ergotron.com
sales@ergotron.com

APAC Sales **Worldwide OEM Sales**
 Tokyo, Japan www.ergotron.com
www.ergotron.com info.oem@ergotron.com
apaccustomerservice@ergotron.com