

LX Dual Stacking Arm, Tall Pole

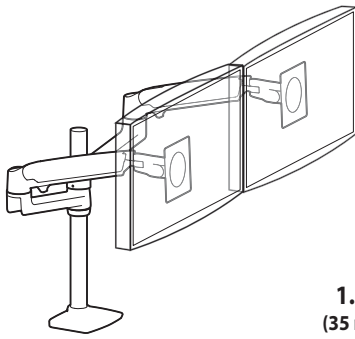

Dimensions

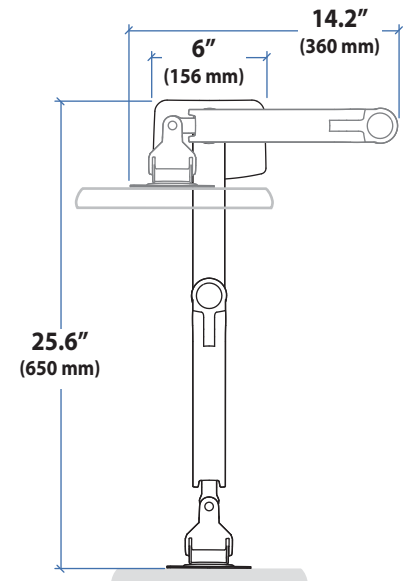
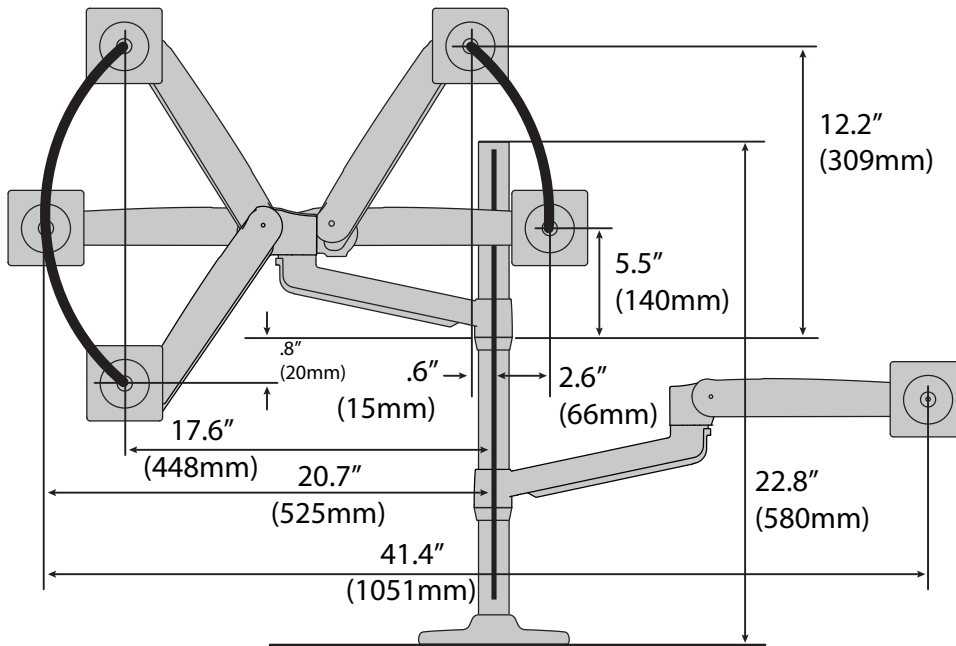
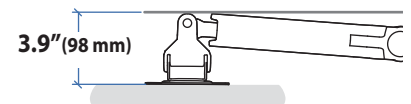
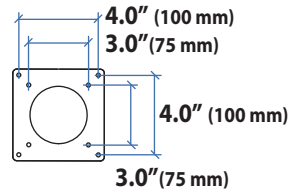
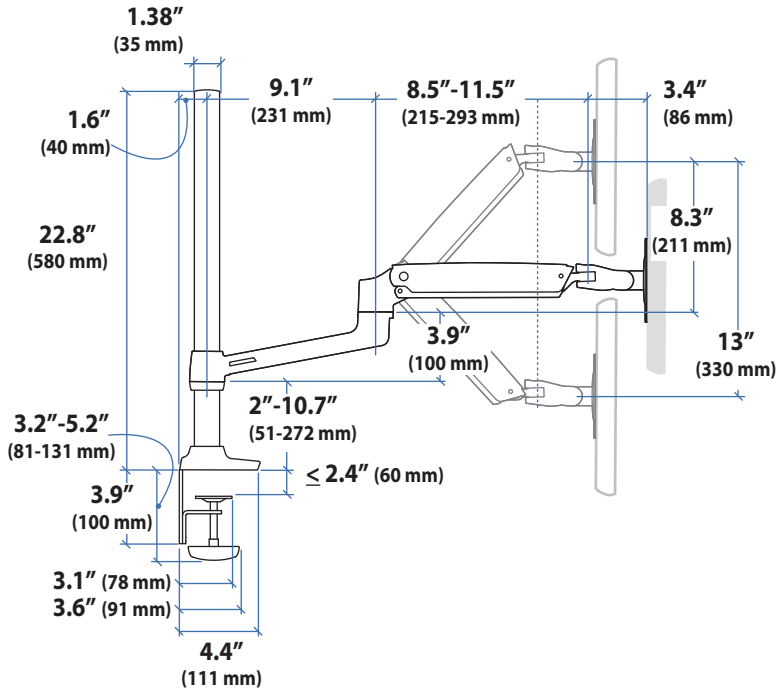

© 2017 Ergotron, Inc. rev. 08/04/2017 DIM-LXDUALSTACKTALL Content is subject to change without notification

Americas Sales and Corporate Headquarters

St. Paul, MN USA
 (800) 888-8458
 +1-651-681-7600
 www.ergotron.com
 sales@ergotron.com

EMEA Sales

Amersfoort, The Netherlands
 +31 33 45 45 600
 www.ergotron.com
 info.eu@ergotron.com

APAC Sales

Tokyo, Japan
 www.ergotron.com
 apaccustomerservice@ergotron.com

Worldwide OEM Sales

www.ergotron.com
 info.oem@ergotron.com



LX Dual Stacking Arm, Tall Pole

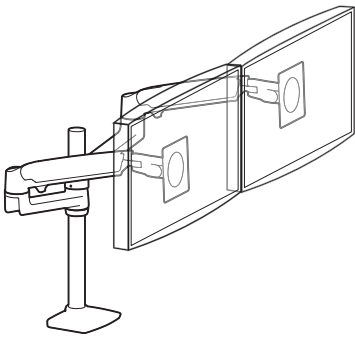

Desk Clamp

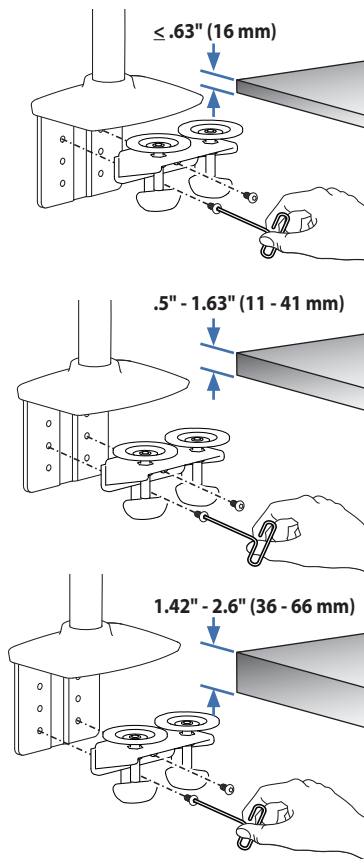

Grommet Mount

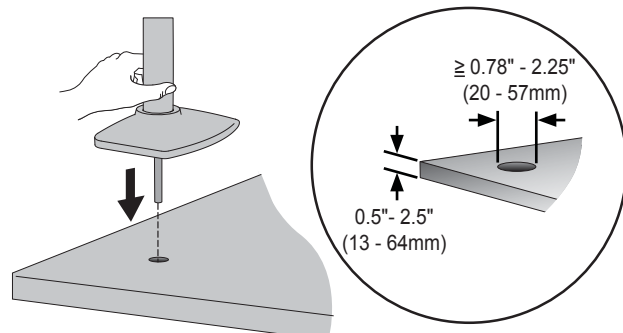

© 2017 Ergotron, Inc. rev. 08/04/2017 DIM-LXDUALSTACKTALL Content is subject to change without notification

Americas Sales and Corporate Headquarters

St. Paul, MN USA
 (800) 888-8458
 +1-651-681-7600
 www.ergotron.com
 sales@ergotron.com

EMEA Sales

Amersfoort, The Netherlands
 +31 33 45 45 600
 www.ergotron.com
 info.eu@ergotron.com

APAC Sales

Tokyo, Japan
 www.ergotron.com
 apaccustomerservice@ergotron.com

Worldwide OEM Sales

www.ergotron.com
 info.oem@ergotron.com



Weight Capacity

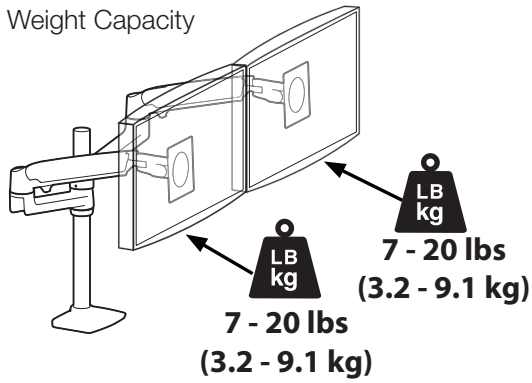

Monitor depth greater than 2.5" (64 mm) may diminish capacity. Call Ergotron for more information.

Dimensional Illustrations

LX Dual Stacking Arm, Tall Pole

Range of Motion

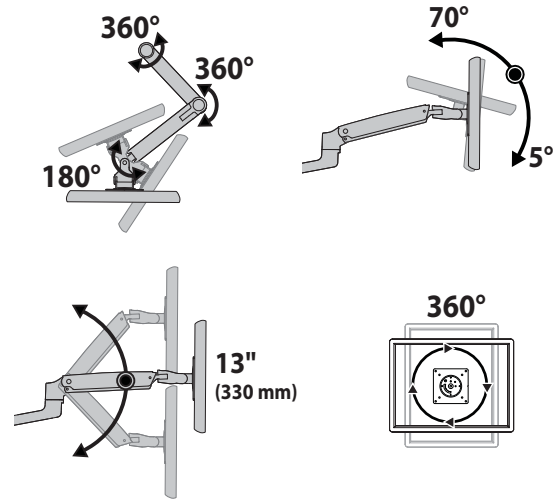

Can have up to 4 arms on a pole.
See updated maximum weight capacities:

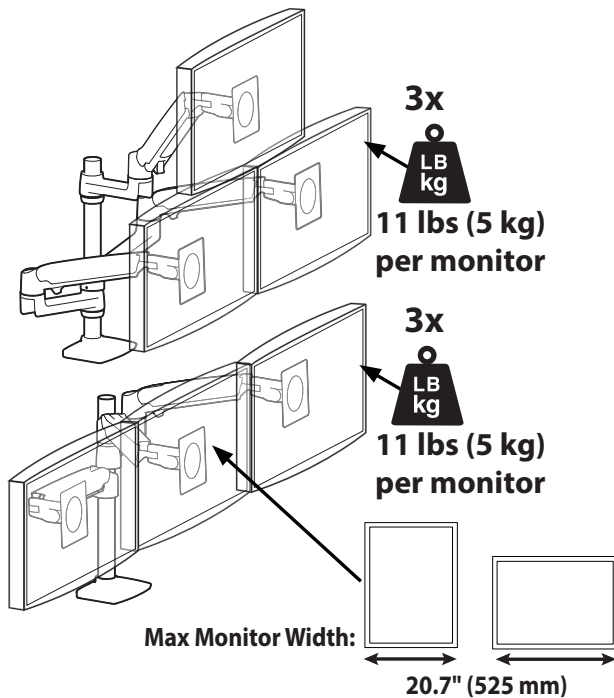

Maximum monitor width will decrease depending on arm configuration.

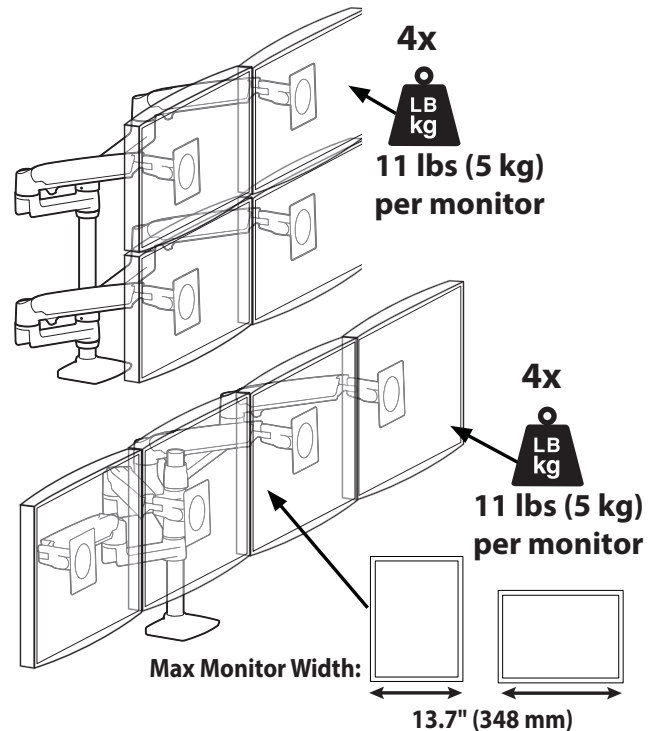

Maximum monitor width will decrease depending on arm configuration.

© 2017 Ergotron, Inc. rev. 08/04/2017 DIM-LXDUALSTACKTALL Content is subject to change without notification

Americas Sales and Corporate Headquarters

St. Paul, MN USA
(800) 888-8458
+1-651-681-7600
www.ergotron.com
sales@ergotron.com

EMEA Sales

Amersfoort, The Netherlands
+31 33 45 45 600
www.ergotron.com
info.eu@ergotron.com

APAC Sales

Tokyo, Japan
www.ergotron.com
apaccustomerservice@ergotron.com

Worldwide OEM Sales

www.ergotron.com
info.oem@ergotron.com

