



WARNING: Ensure that the wall structure is capable of supporting four times the total weight of mounted equipment. Mounting to wall surfaces that do not meet this criteria may result in an unstable, unsafe condition which could lead to personal injury and/or property damage. Consult a construction professional if you have any doubt about what this means in regard to your particular application.

AVISO: Verifi que que la pared donde vaya a instalar el Soporte de pared es capaz de soportar 4 veces el peso total del equipamiento a instalar. El montaje del monitor en una pared que no cumpla estos requisitos puede conducir a una instalación inestable e insegura y derivar en daños personales y/o de la pared y el monitor. Consulte a un instalador profesional si tiene dudas respecto de su caso particular.

ATTENTION: Assurez vous que le mur sur lequel vous allez monter est capable de supporter 4 fois le poids total du matériel. Un montage sur une surface critique peut générer une faiblesse dans l'installation et causer des dommages corporels et/ou matériels. En cas de doute, contactez un professionnel.

AVISO: Assegure-se que a estrutura da parede pode suportar quatro vezes o peso do equipamento instalado. A instalação de equipamento em paredes que não possuem esta característica pode provocar uma situação instável e não muito segura, que poderá originar danos pessoais e/ou do equipamento. Consulte um profissional da área de construção civil se tiver alguma dúvida no que diz respeito ao exposto atrás em relação à instalação do seu equipamento.

Achtung: Stellen Sie sicher, daß die Wand an der Sie das Display montieren wollen mindestens das vierfache Gewicht der zu befestigenden Geräte tragen kann. Eine Befestigung an Oberflächen, die nicht in der Lage ist, dieses Kriterium zu erfüllen, könnte zu einem instabilen und/oder unsicheren Zustand führen, welcher Personen- oder Sachschaden zur Folge haben könnte.

WAARSCHUWING: Zorg ervoor dat de wand waartegen de Directe wandbevestiging bevestigd zal worden geschikt is om vier keer het totale gewicht van de apparatuur te dragen. Het bevestigen van een beeldscherm aan een wand die hier niet aan voldoet kan leiden tot een onstabiele en onveilige situatie wat lichamelijk letsel, schade aan de muur en het beeldscherm kan veroorzaken.

ATTENZIONE Verifi cate con attenzione che la struttura della parete il dispositivo di Montaggio a parete a basso spessore possa reggere un peso maggiore a quattro volte il valore totale di tutte le apparecchiature montate. Il montaggio su pareti che non soddisfino - no questo requisito può comportare instabilità e scarsa sicurezza, con conseguente rischio di danni od infortuni sia alle persone che alle cose.

警告: 壁の構造が取付ける機器の四倍の重量をサポートする強度が必要です。この基準に適合しない壁表面に取付けるとけが及び/または物的損害の原因となる不安定で危険な状況となりかねません。特定用途に壁の強度の良し悪しが懸念される場合は建設業者にご相談ください。

警告: 确保墙体结构能够支撑四倍于安装设备的总重量。安装到不符合本标准的墙面可能造成不稳定、不安全的情况,进而导致人员伤亡及/或财产损失。如果您对具体应用 还存有疑惑,请咨询建筑专业人士。

10"
254 mm

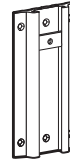

26"
660 mm



34"
864 mm



42"
1067 mm

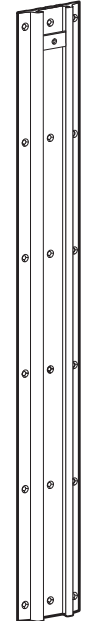

www.ergotron.com

USA 1-800-888-8458

Europe +31 (0)33-45 45 600

China 86-769-86018920



1x

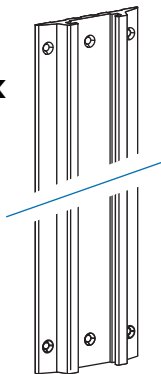

	10"	26"	34"	42"
1x	12"	12"	12"	18"
1x		12"	18"	18"

1x



1x



Stud Finder
 Localizador de largueros de madera
 Stud Finder
 Auswahl von Montagmaterial
 Positiebepaler balken
 Rilevatore di montanti
 Balkfinnare
 スタッド ファインダー
 螺栓探测器

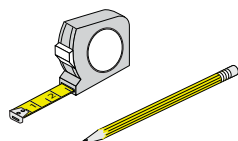
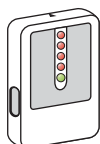

3 mm

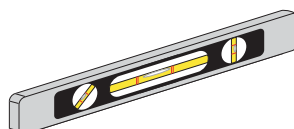
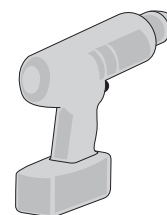

Ø 5/32" (4 mm)
 Wood
 Madera
 Bois
 Solide Holz-
 balkenträger
 Massief Houten
 Pilaren
 Due montanti in
 legno massiccio
 木质



Ø 1/2" (12.8 mm)
 Hollow Wall
 Pared
 .21875Mur
 Wand
 Muur
 Parete
 Ihålig vägg
 壁
 墙壁

Wall Track
 Guía para pared
 Montant mural
 Profilschiene
 Muurrail
 Guida a parete
 Väggspar
 ウォールトラック

Dimensions
 Dimensiones
 Dimensions
 Abmessungen
 Afmetingen
 Dimensioni
 Mått
 寸法

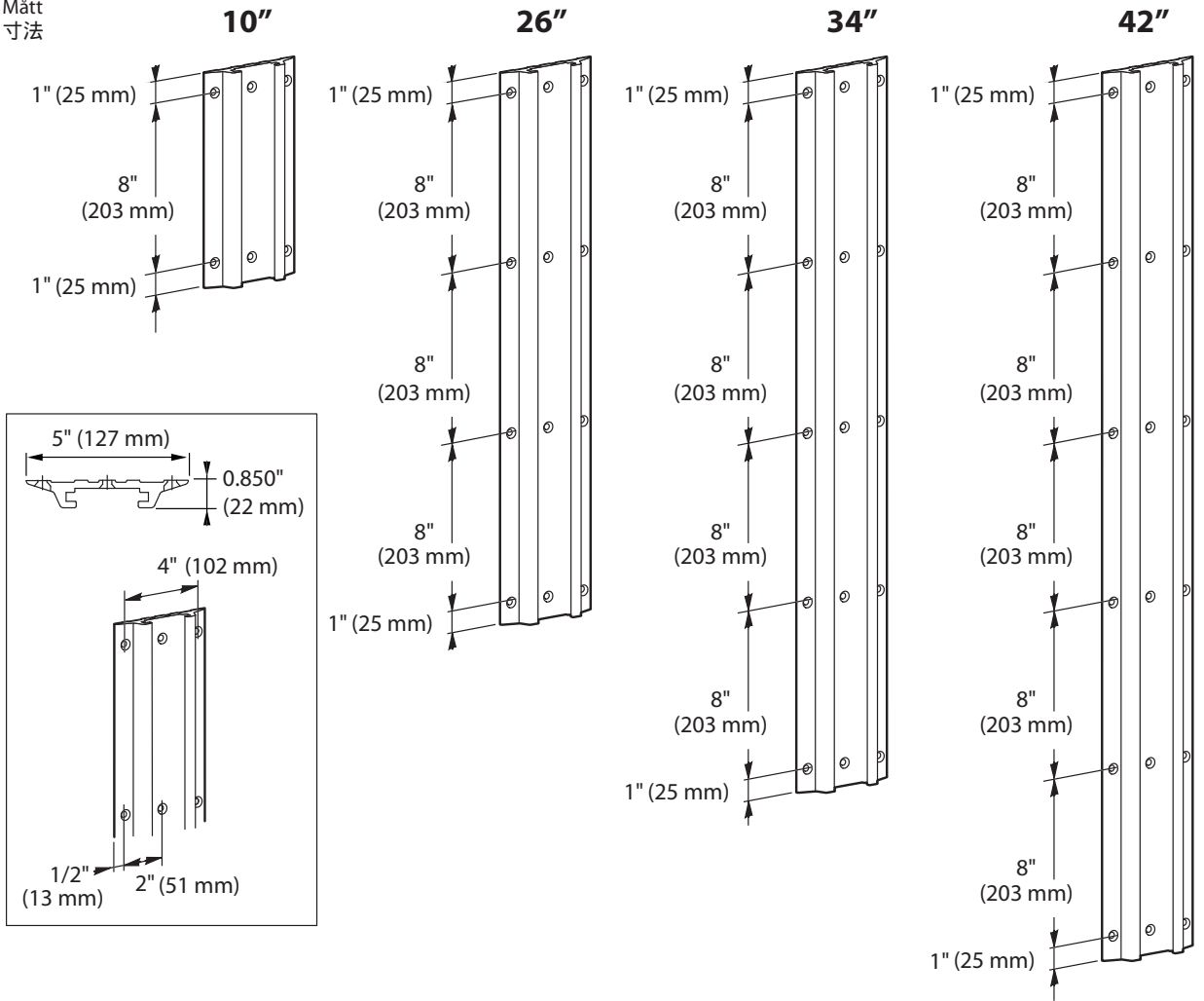

Wood
 Madera
 Bois
 Solide Holzbalkenträger
 Massief Houten Pilaren
 Due montanti in legno
 Massiccio
 木
 木质

Metal Stud
 Tacha
 Poteaux Métalliques
 Metallbolzen
 Metalen Steun
 Perno di Metallo
 Suporte de Metal
 金属のスタッド
 金属螺柱

Sheetrock
 Sheetrock
 Plaque de plâtre
 Rigipsplatte
 Sheetrock
 CartongessoGipsskiva
 シートロック
 石膏板

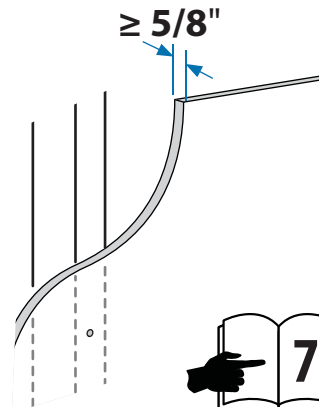
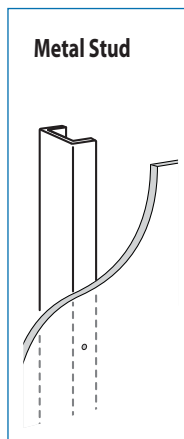
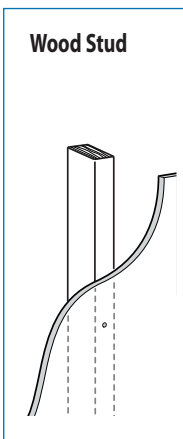

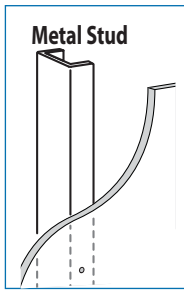
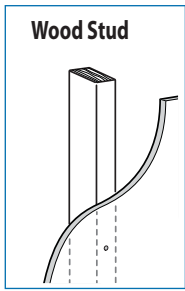

1a

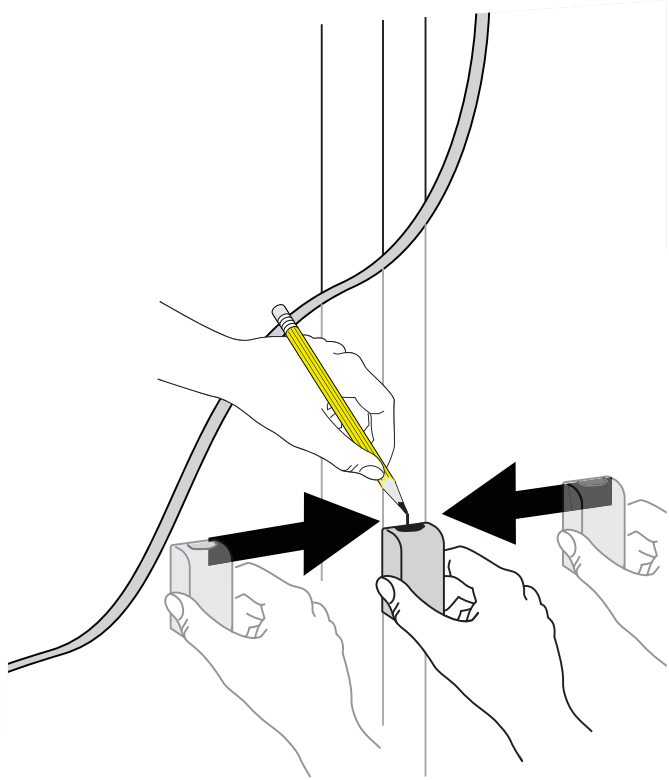
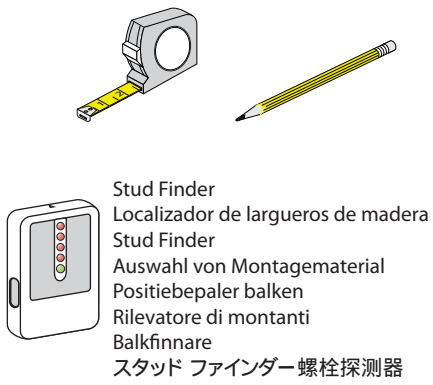

b

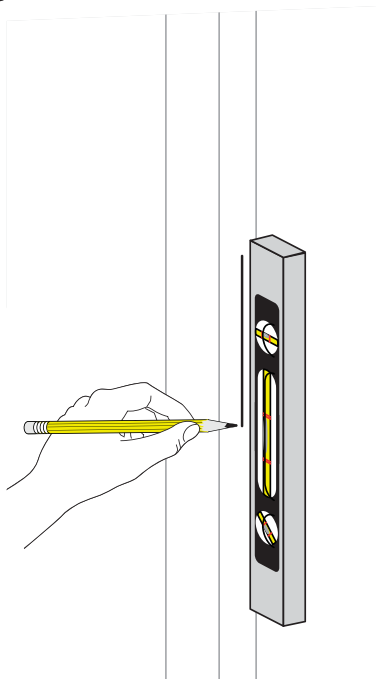
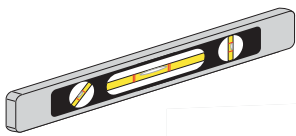

c

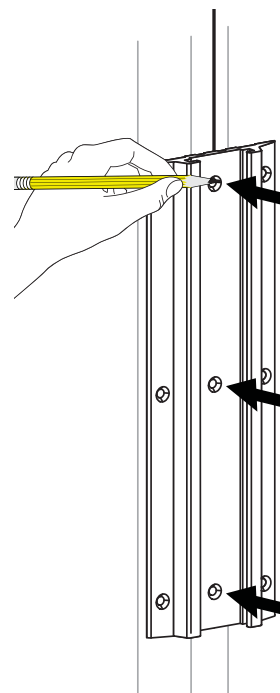

2

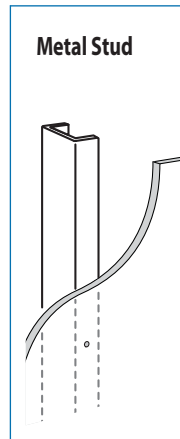
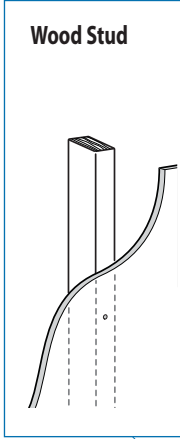
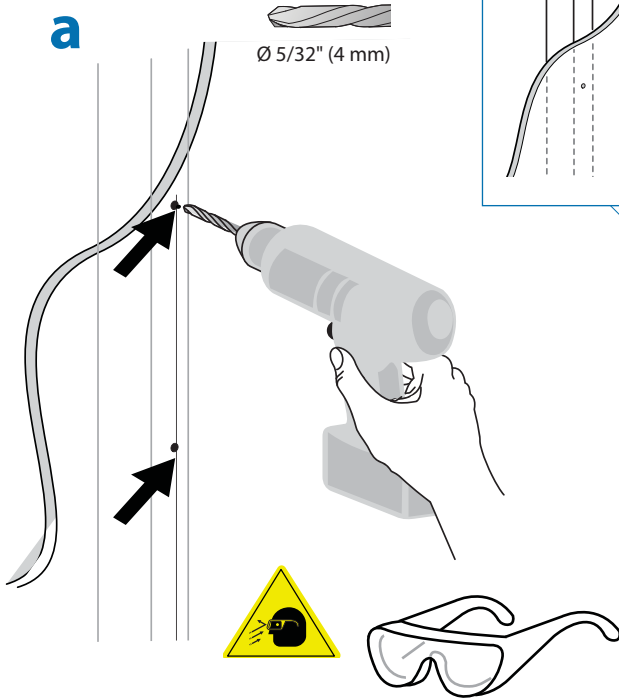

a

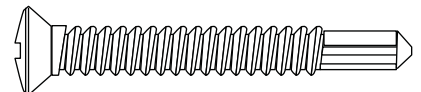

2x - 6x

M6.3 x 1.8 x 50 mm (2")

Customer supplied fasteners
 Tornillería suministrada por el cliente
 Attaches fournies par le client
 Fixadores fornecidos ao cliente
 Vom Kunden beigestellte Halterungen.
 Door klant geleverde gespen
 Dispositivi di fissaggio forniti dal cliente
 客户提供的紧固件

b

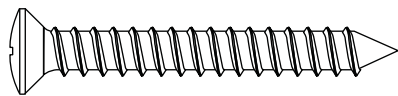

2x - 6x

M6.3 x 2.5 x 50 mm (2")

Customer supplied fasteners
 Tornillería suministrada por el cliente
 Attaches fournies par le client
 Fixadores fornecidos ao cliente
 Vom Kunden beigestellte Halterungen.
 Door klant geleverde gespen
 Dispositivi di fissaggio forniti dal cliente
 客户提供的紧固件

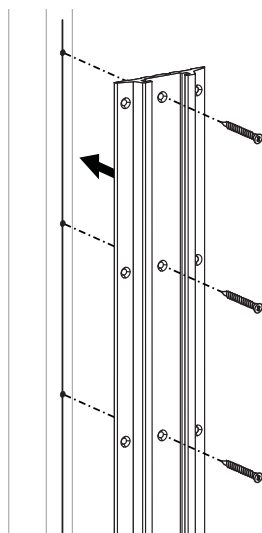
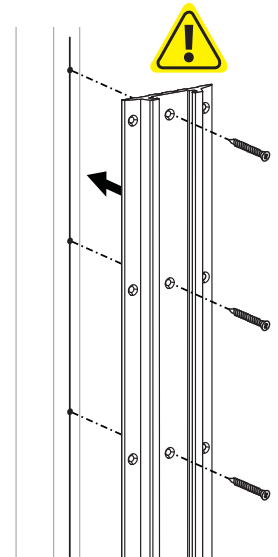

CAUTION: Make sure the wall mount bracket is level, flush and snug to the wall surface.

PRECAUCIÓN: Asegúrese de que la fijación de la montura en pared está nivelada, iguálela y ajústela respecto a la pared.

AVERTISSEMENT : assurez vous que le support mural soit bien à plat et contre la surface du mur.

VORSICHT: Bitte versichern sie sich, dass die Wandhalterung gerade befestigt ist und dabei dicht an der Wand anliegt.

LET OP: zorg ervoor dat de muurbevestigingsbeugel recht is, gelijk aan en nauwsluitend met het muropervlak.

ATTENZIONE: verificare che la staffa di fissaggio a parete sia parallela ad essa, pari e aderente alla superficie.

WARNING: Se till att fästet för väggmonteringen är lodrätt, rakt och ligger tätt emot väggytan.

注意：壁取り付けブラケットが壁の表面に水平に接触してぴったりおさまっているか確認してください。

注意：请确保壁挂式安装支架水平、平直并紧贴墙壁。

3



Hollow Wall

- Pared
- Mur
- Wand
- Muur
- Parete
- Ihålig vägg
- 壁
- 墙壁

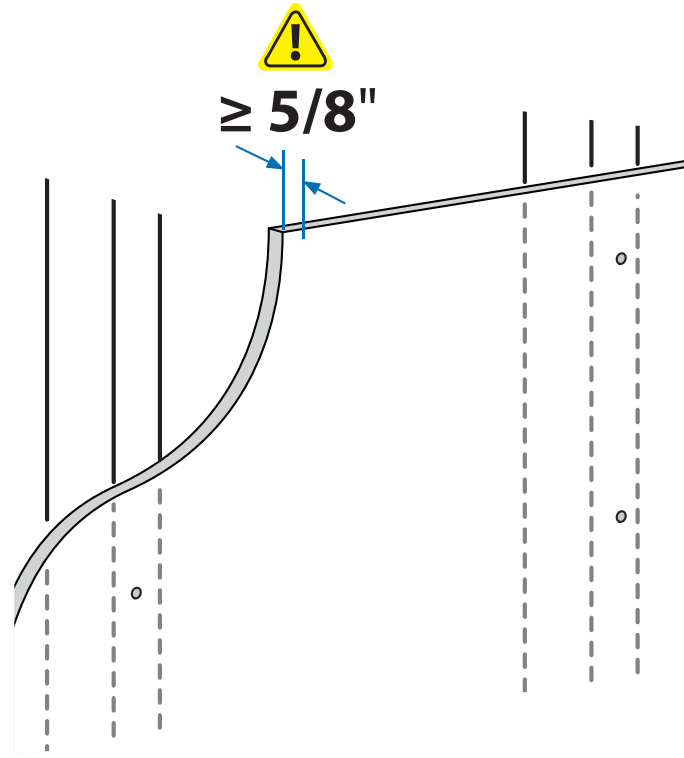

Requires minimum material thickness of 5/8" (16 mm).

Requiere un grosor mínimo de 16 mm.

Epaisseur minimum de 16 mm.

Requer uma espessura mínima de 5/8" (16 mm).

Mit einer Materialdicke von mindestens 16 mm.

Vereist een minimale materiaaldikte van 1.6 cm.

Richiede uno spessore del materiale non inferiore a 16 mm.

Kräver minst 16 mm materialjocklek.

需要最低材料厚度为 5/8" (16 mm)。

厚さが最低 5/8" (16 mm) の資材が必要。

1a

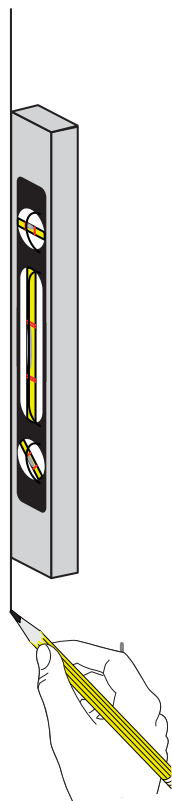

b

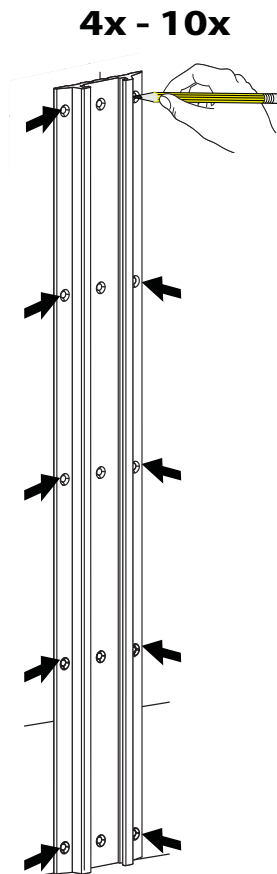

c

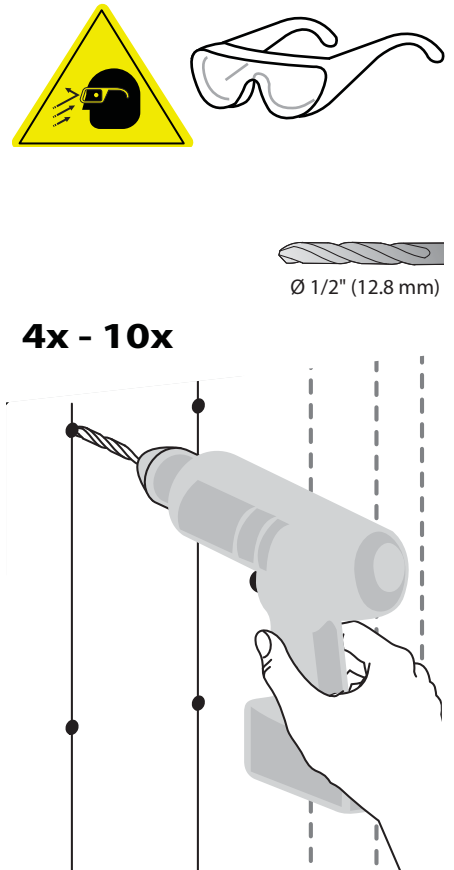

2

4x - 10x

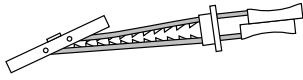

4x - 10x

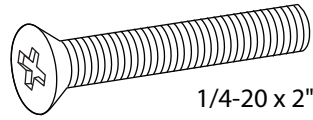

1/4-20 x 2"

Customer supplied fasteners
 Tornillería suministrada por el cliente
 Attaches fournies par le client
 Fixadores fornecidos ao cliente
 Vom Kunden beigestellte Halterungen.
 Door klant geleverde gespen
 Dispositivi di fissaggio forniti dal cliente
 客户提供的紧固件

a

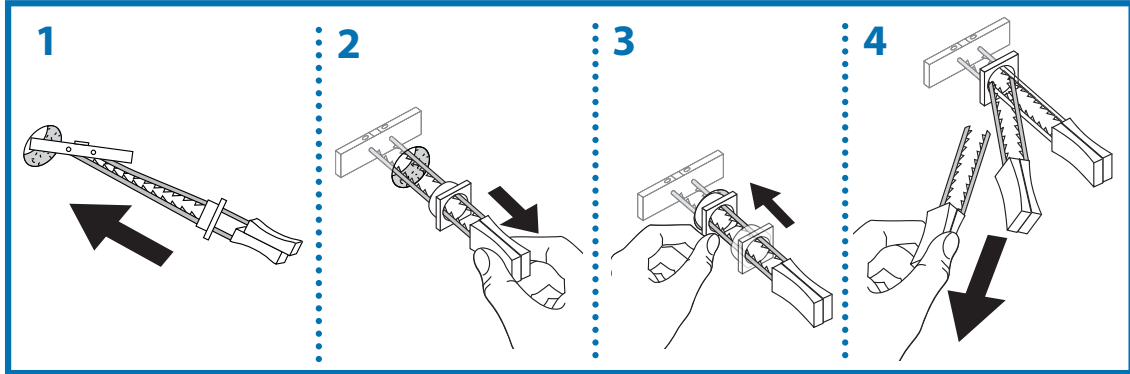

b

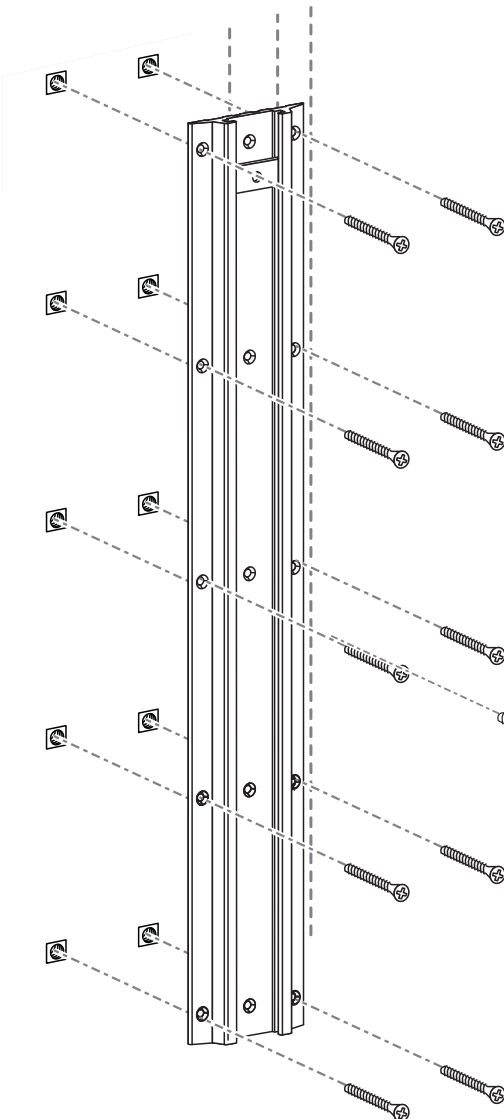

CAUTION: Make sure the wall mount bracket is level, flush and snug to the wall surface.

PRECAUCIÓN: Asegúrese de que la fijación de la montura en pared está nivelada, iguálela y ajústela respecto a la pared.

AVERTISSEMENT : assurez vous que le support mural soit bien à plat et contre la surface du mur.

VORSICHT: Bitte versichern sie sich, dass die Wandhalterung gerade befestigt ist und dabei dicht and der Wand anliegt.

LET OP: zorg ervoor dat de muurbevestigingsbeugel recht is, gelijk aan en nauwsluitend met het muuroppervlak.

ATTENZIONE: verificare che la staffa di fissaggio a parete sia parallela ad essa, pari e aderente alla superficie.

WARNING: Se till att fästet för väggmonteringen är lodrätt, rakt och ligger tätt emot väggytan.

注意：壁取り付けブラケットが壁の表面に水平に接触してぴったりおさまっているか確認してください。

注意：请确保壁挂式安装支架水平、平直并紧贴墙壁。



3a

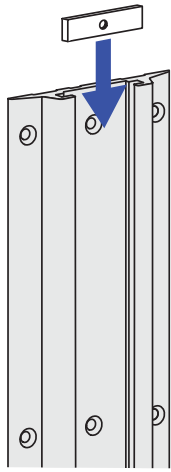

b

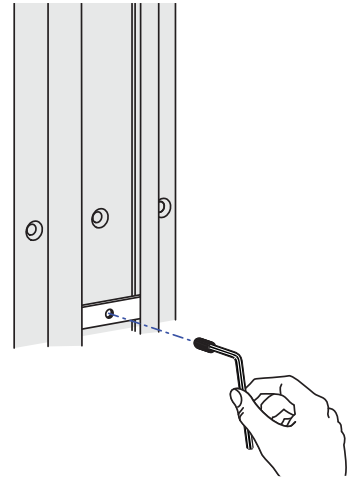
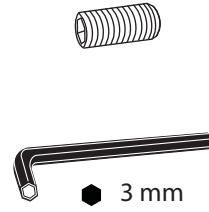

4a

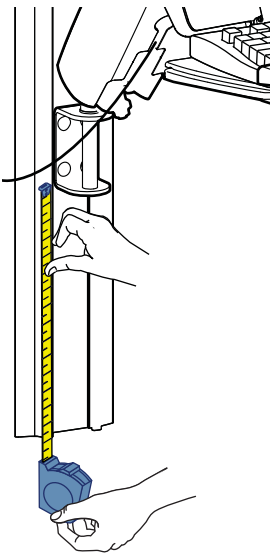

b

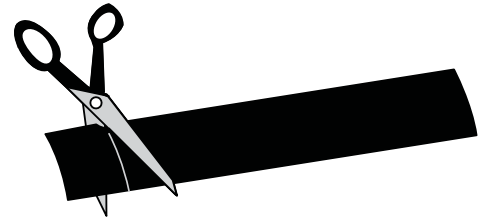
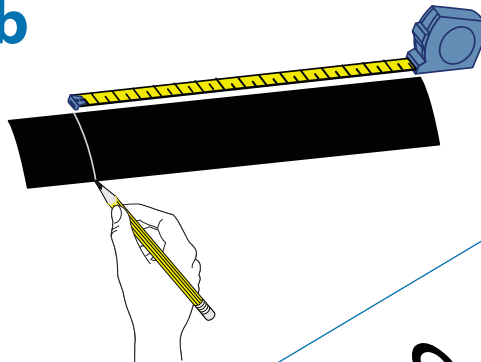

c

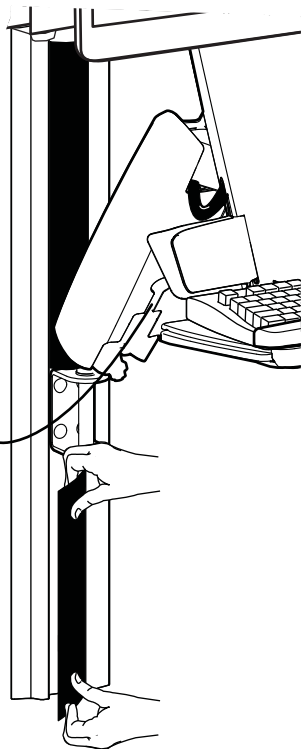

For service and warranty visit www.ergotron.com
 Si desea información de servicio y garantía, visite www.ergotron.com
 Pour toute question concernant la garantie ou le service client, consultez www.ergotron.com
 Weitere Informationen zu Service und Gewährleistung erhalten Sie unter www.ergotron.com.
 Ga voor service en garantie naar www.ergotron.com
 Per assistenza e la garanzia visitate www.ergotron.com
 Gå in på www.ergotron.com för service och garanti
 サービスおよび保証について詳しくは、www.ergotron.com をご覧ください。
 有关服务和保修，请访问 www.ergotron.com



© 2011 Ergotron, Inc.
 All rights reserved.

While Ergotron, Inc. makes every effort to provide accurate and complete information on the installation and use of its products, it will not be held liable for any editorial errors or omissions (including those made in the process of translation from English to another language), or for incidental, special or consequential damages of any nature resulting from furnishing this instruction and performance of equipment in connection with this instruction. Ergotron, Inc. reserves the right to make changes in the product design and/or product documentation without notification to its users. For the most current product information, or to know if this document is available in languages other than those herein, please contact Ergotron. No part of this publication may be reproduced, stored in a retrieval system, or transmitted in any form or by any means, electronic, mechanical, photocopying, recording or otherwise without the prior written consent of Ergotron, Inc., 1181 Trapp Road, Eagan, Minnesota, 55121, USA Patents Pending and Patented U.S. & Foreign. Ergotron is a registered trademark of Ergotron, Inc.

Americas Sales and Corporate Headquarters

St. Paul, MN USA
 (800) 888-8458
 +1-651-681-7600
www.ergotron.com
sales@ergotron.com

EMEA Sales

Amersfoort, The Netherlands
 +31 33 45 45 600
www.ergotron.com
info.eu@ergotron.com

APAC Sales

Tokyo, Japan
www.ergotron.com
apaccustomerservice@ergotron.com

Worldwide OEM Sales

www.ergotron.com
info.oem@ergotron.com