

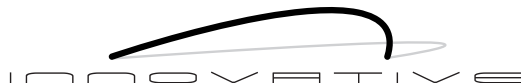

# EVO® 5501 Installation Instructions

www.LCDarms.com | 800.524.2744

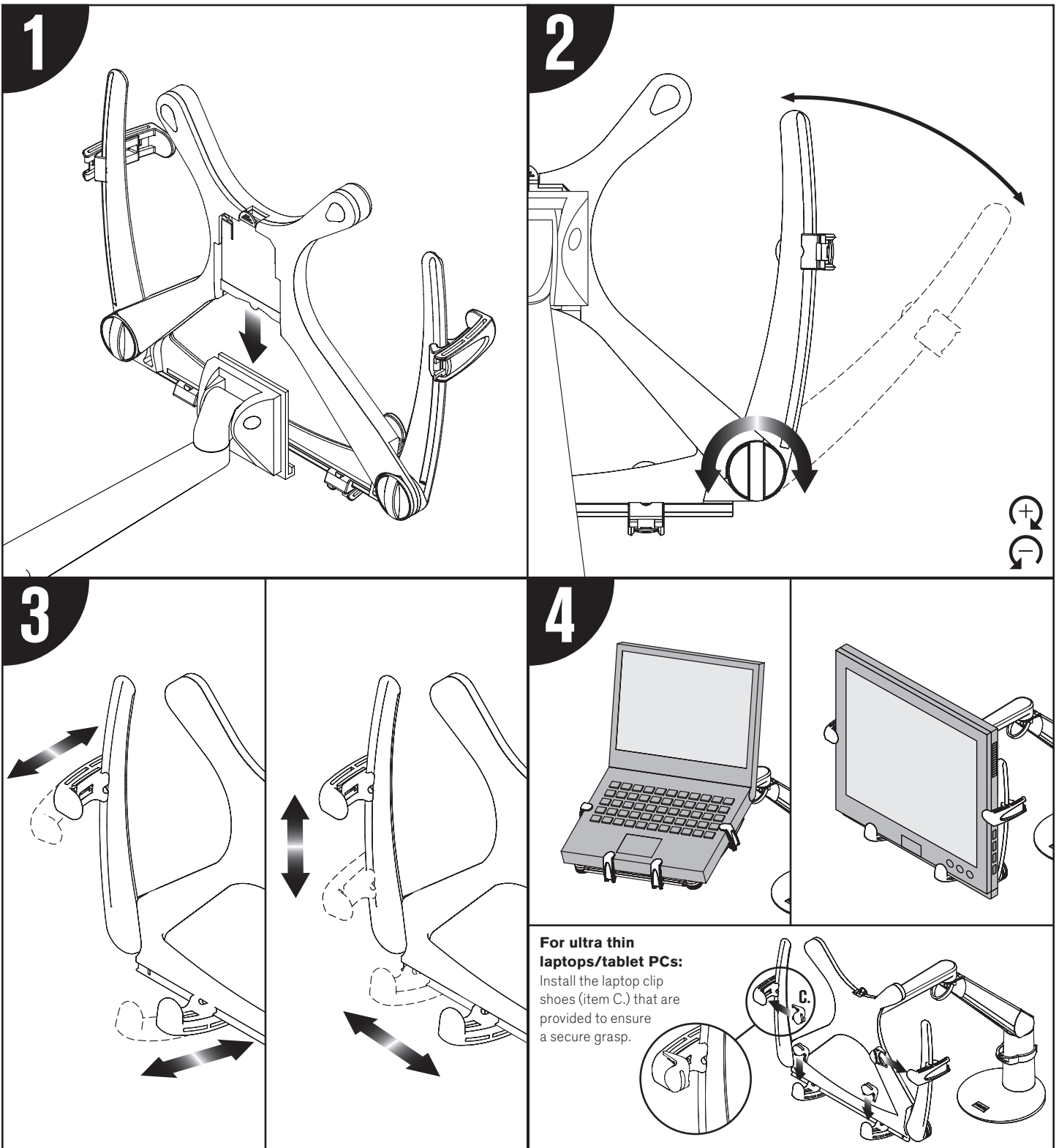

# EVO® 5501 Parts List

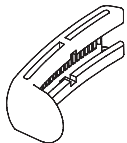
www.LCDarms.com | 800.524.2744

ITEM	DESCRIPTION / PART NO.	QUANTITY
A. 	<b>Adjustable clasp</b> 105479	4
B. 	<b>Adjustable clasp base</b> 105478	4
C. 	<b>Laptop clip shoe</b> 106096	4

This product is protected by one or more of the following U.S. Patent Nos. and other United States and foreign patents applied for: 119,345, 119,346, 1,324,842, 2,470,525, 6,076,785, 6,273,383, 6,409,134, 6,478,274, 6,499,704, 6,505,988, 6,609,691, 6,191,606, 6,719,253, 6,726,167, 6,736,364, 6,783,105, 6,854,698, 6,915,994, 6,935,883, 6,955,328, 6,983,917, 6,986,489, 7,014,157, 7,017,874, 7,048,242, 7,059,574, 7,063,296, 7,066,433, 7,066,435, 7,389,965, D435,852, D491,952, D492,893, D570,853, D575,293. EVO® is a trademark of Innovative Office Products, Inc., registered in the U.S. Patent and Trademark Office.





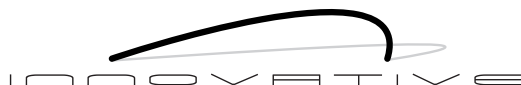
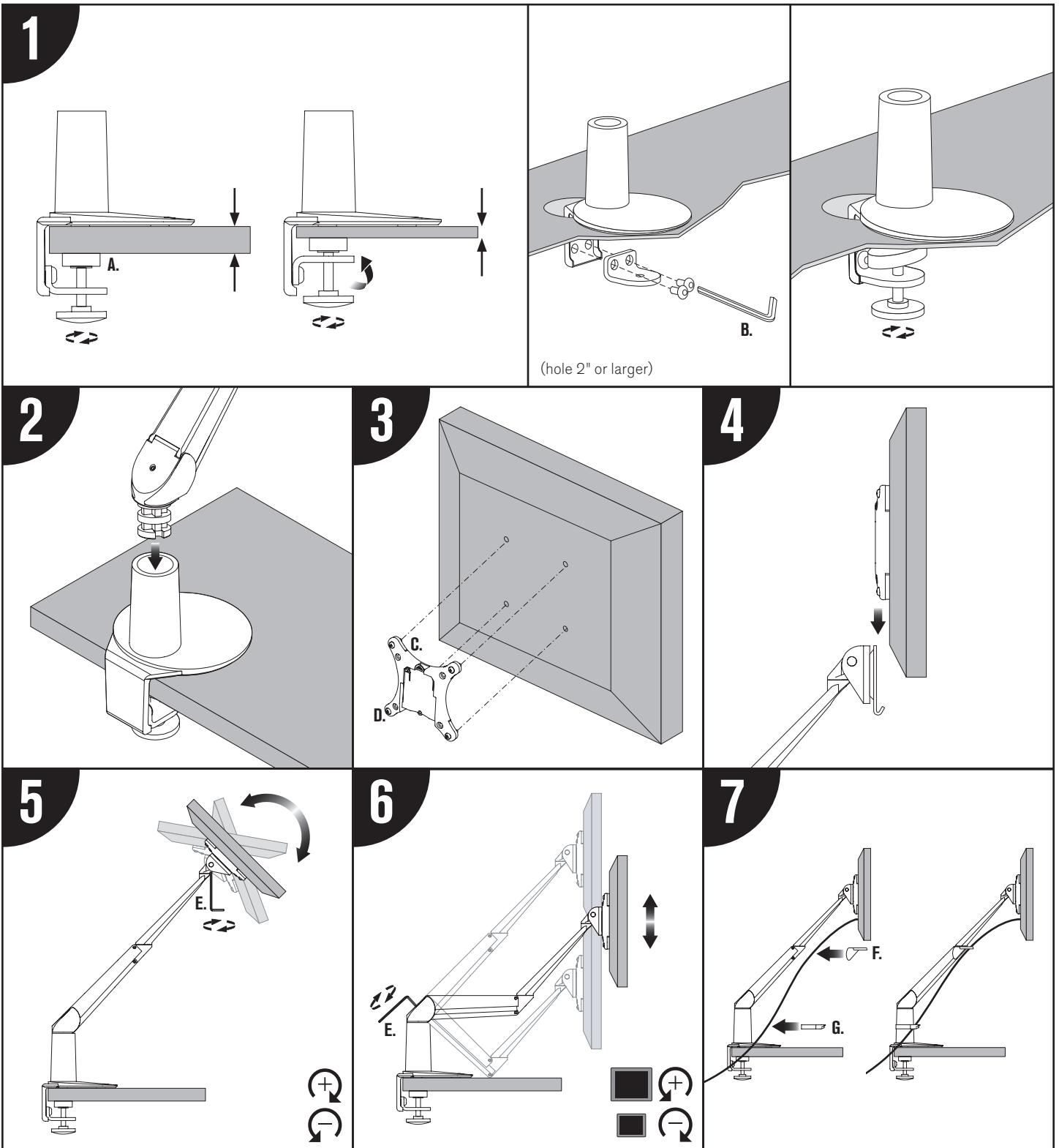

# EVO<sup>®</sup> 5545 Installation Instructions

www.LCDarms.com | 800.524.2744

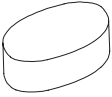

# EVO<sup>®</sup> 5545 Parts List

www.LCDarms.com | 800.524.2744

ITEM	DESCRIPTION / PART NO.	QUANTITY	
A.		<b>FLEXmount screw plate</b> 104753	1
B.		<b>7/32" Allen wrench</b> 701127	1
C.		<b>Spacer-screw retainer</b> 104887	4
D.		<b>M4 x .7 x 18mm screw</b> 704917	4
E.		<b>3mm hex key</b> 701313	1
F.		<b>Cable clip</b> 105104	1
G.		<b>Lower cable clip</b> 104484	1