

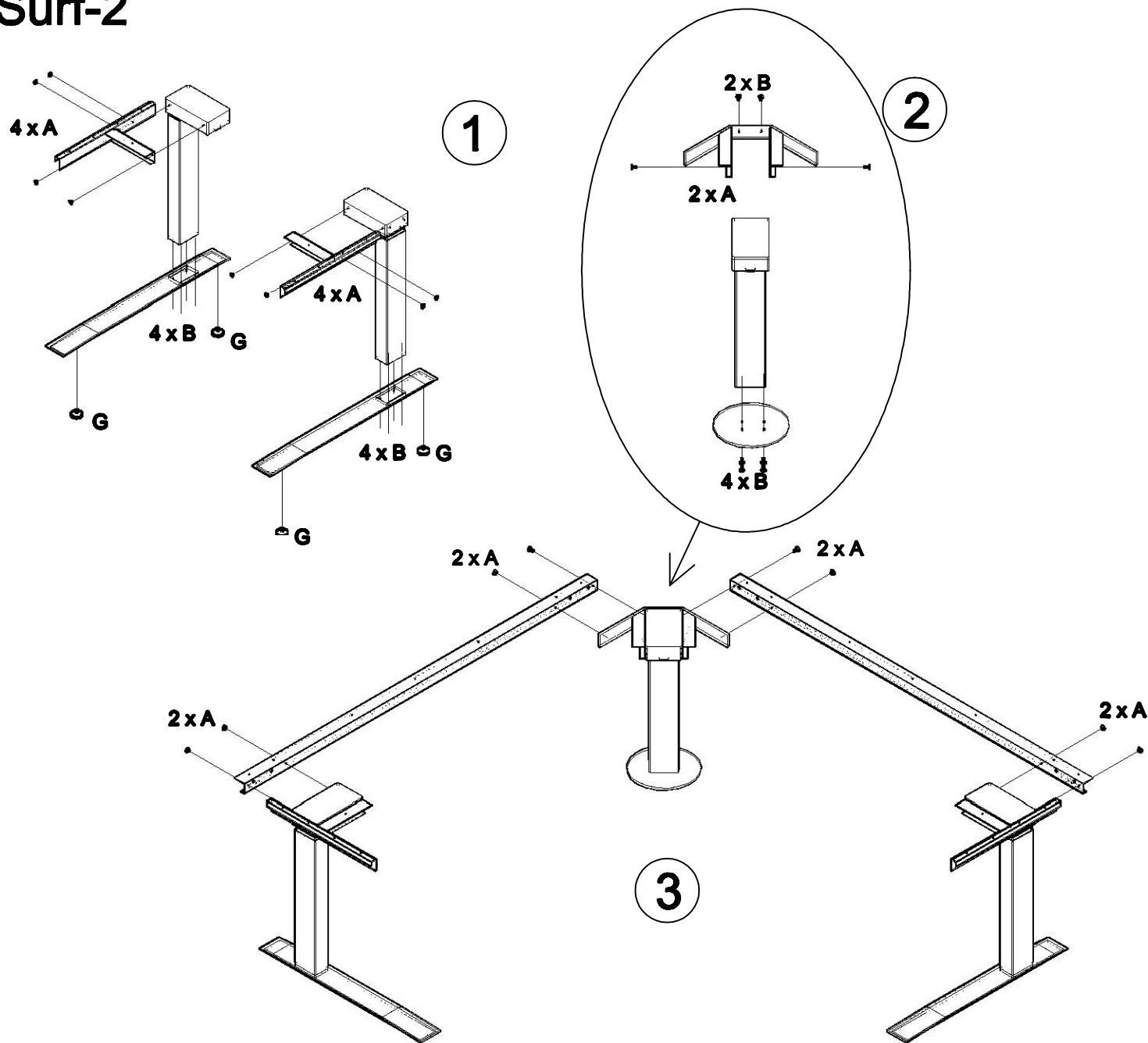





# Surf-2

# 3 leg

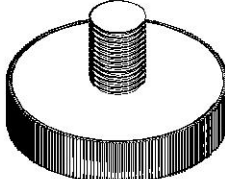

<b>A</b> R011073		<b>X 18</b>
<b>B</b> R011057		<b>X 14</b>
<b>C</b> R011502		<b>X 34</b>
<b>D</b> R011500		<b>X 28</b>
<b>E</b> R011525		<b>X 2</b>
<b>F</b> R010230		<b>X 20</b>
<b>G</b> RM-175		<b>X 4</b>