

# BALT<sup>®</sup>

## #85052 Web-AV

Adjustable Bi-Level  
Presentation/Stand-Up Workstation

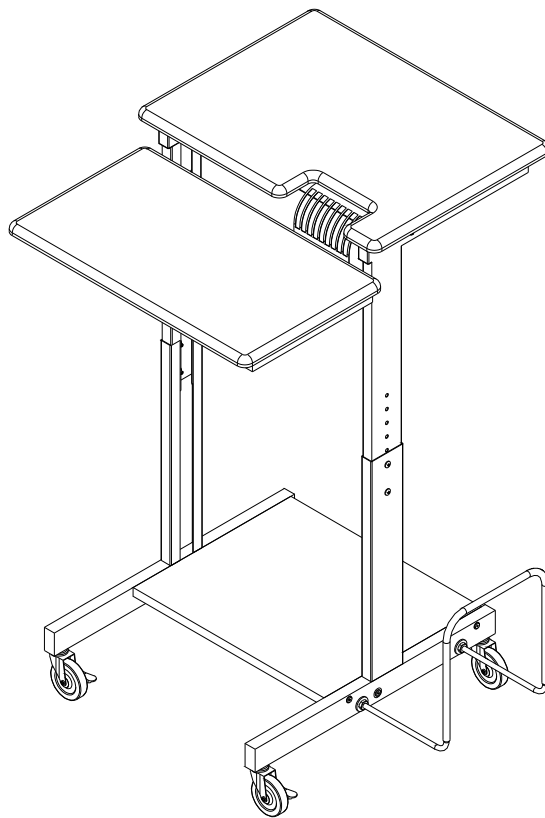









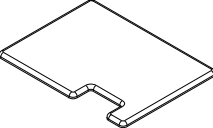











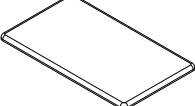
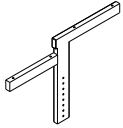
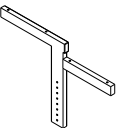
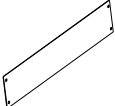

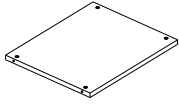
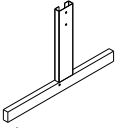
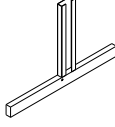
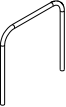











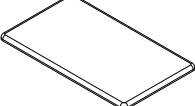
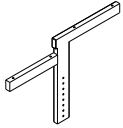
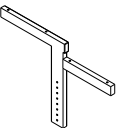
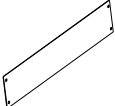

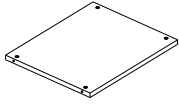
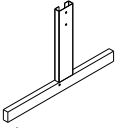
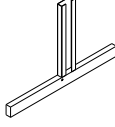
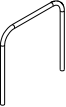







# Assembly Instructions

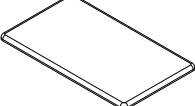
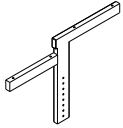
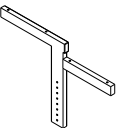
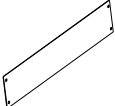

**#85052 WEB-AV**

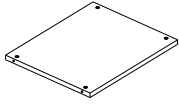
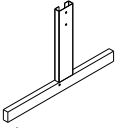
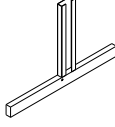
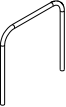
Adjustable Bi-Level Presentation/Stand-Up Workstation  
Assembly Instructions

Part	Drawing	Description	Qty	Part	Drawing	Description	Qty																																																																																				
P-1		Monitor Shelf	1 EA	<div style="border: 2px solid black; border-radius: 15px; padding: 10px;"> <p style="text-align: center;"><b>Hardware List</b></p> <table border="0"> <tr> <td>A</td> <td></td> <td>9/16" Socket Screw</td> <td>12 EA</td> </tr> <tr> <td>A1</td> <td></td> <td>1-7/8" Socket Screw</td> <td>4 EA</td> </tr> <tr> <td>A2</td> <td></td> <td>2-1/2" Socket Screw</td> <td>8 EA</td> </tr> <tr> <td>C</td> <td></td> <td>Square Nut</td> <td>4 EA</td> </tr> <tr> <td>D</td> <td></td> <td>3" Locking Caster</td> <td>2 EA</td> </tr> <tr> <td>E</td> <td></td> <td>3" Caster</td> <td>2 EA</td> </tr> <tr> <td>F</td> <td></td> <td>Black Plastic Spacer</td> <td>2 EA</td> </tr> <tr> <td>G</td> <td></td> <td>Hex Nut</td> <td>4 EA</td> </tr> <tr> <td>H</td> <td></td> <td>Flat Washer</td> <td>4 EA</td> </tr> <tr> <td>J</td> <td></td> <td>Allen Wrench</td> <td>1 EA</td> </tr> <tr> <td>K</td> <td></td> <td>Open End Wrench</td> <td>1 EA</td> </tr> </table> </div> <tr> <td>P-2</td> <td></td> <td>Keyboard Shelf</td> <td>1 EA</td> </tr> <tr> <td>P-3</td> <td></td> <td>Right Upper Insert</td> <td>1 EA</td> </tr> <tr> <td>P-4</td> <td></td> <td>Left Upper Insert</td> <td>1 EA</td> </tr> <tr> <td>P-5</td> <td></td> <td>Stability Panel</td> <td>1 EA</td> </tr> <tr> <td>P-6</td> <td></td> <td>CD Rack</td> <td>1 EA</td> </tr> <tr> <td>P-7</td> <td></td> <td>Accessory Shelf</td> <td>1 EA</td> </tr> <tr> <td>P-8</td> <td></td> <td>Right Leg Receiver</td> <td>1 EA</td> </tr> <tr> <td>P-9</td> <td></td> <td>Left Leg Receiver</td> <td>1 EA</td> </tr> <tr> <td>P-10</td> <td></td> <td>CPU Sleeve</td> <td>1 EA</td> </tr> <tr> <td>P-11</td> <td></td> <td>CPU Rod</td> <td>2 EA</td> </tr>				A		9/16" Socket Screw	12 EA	A1		1-7/8" Socket Screw	4 EA	A2		2-1/2" Socket Screw	8 EA	C		Square Nut	4 EA	D		3" Locking Caster	2 EA	E		3" Caster	2 EA	F		Black Plastic Spacer	2 EA	G		Hex Nut	4 EA	H		Flat Washer	4 EA	J		Allen Wrench	1 EA	K		Open End Wrench	1 EA	P-2		Keyboard Shelf	1 EA	P-3		Right Upper Insert	1 EA	P-4		Left Upper Insert	1 EA	P-5		Stability Panel	1 EA	P-6		CD Rack	1 EA	P-7		Accessory Shelf	1 EA	P-8		Right Leg Receiver	1 EA	P-9		Left Leg Receiver	1 EA	P-10		CPU Sleeve	1 EA	P-11		CPU Rod	2 EA
A		9/16" Socket Screw	12 EA																																																																																								
A1		1-7/8" Socket Screw	4 EA																																																																																								
A2		2-1/2" Socket Screw	8 EA																																																																																								
C		Square Nut	4 EA																																																																																								
D		3" Locking Caster	2 EA																																																																																								
E		3" Caster	2 EA																																																																																								
F		Black Plastic Spacer	2 EA																																																																																								
G		Hex Nut	4 EA																																																																																								
H		Flat Washer	4 EA																																																																																								
J		Allen Wrench	1 EA																																																																																								
K		Open End Wrench	1 EA																																																																																								
P-2		Keyboard Shelf	1 EA																																																																																								
P-3		Right Upper Insert	1 EA																																																																																								
P-4		Left Upper Insert	1 EA																																																																																								
P-5		Stability Panel	1 EA																																																																																								
P-6		CD Rack	1 EA																																																																																								
P-7		Accessory Shelf	1 EA																																																																																								
P-8		Right Leg Receiver	1 EA																																																																																								
P-9		Left Leg Receiver	1 EA																																																																																								
P-10		CPU Sleeve	1 EA																																																																																								
P-11		CPU Rod	2 EA																																																																																								

**Should you require assistance during assembly,  
please call our Customer Service Department  
Monday - Friday 8 a.m. - 5 p.m. Central Standard Time  
Toll-Free Customer Service  
**1-800-749-2258****

Do not use unless all screws are tight. At least every six months, check all screws to be sure they are tight. If parts are missing, broken, damaged, or worn, stop use of the product until repairs are made by your dealer using factory authorized parts.

# #85052 Web-AV Assembly Diagram



Illustration # 1

**READ THROUGH INSTRUCTIONS FROM BEGINNING TO END BEFORE STARTING TO ASSEMBLE UNIT.**

To Assemble:

- 1.) Separate and Identify all the Parts and Hardware.
- 2.) Attach Monitor Shelf (P-1) to Right Upper Insert (P-3) and Left Upper Insert (P-4), using 4 each (A2) Socket Screws. Attach Keyboard Shelf (P-2) using 4 each (A2) Socket Screws as shown in illustration # 1.
- 3.) Attach CD Rack (P-6) using 4 each (A) screws. Attach as shown in illustration # 1.

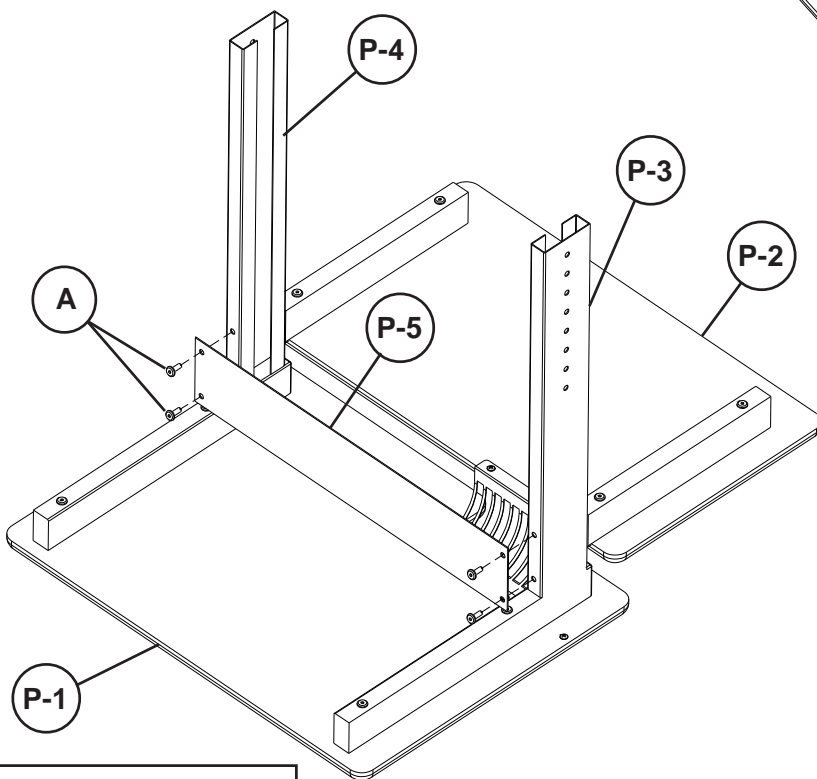
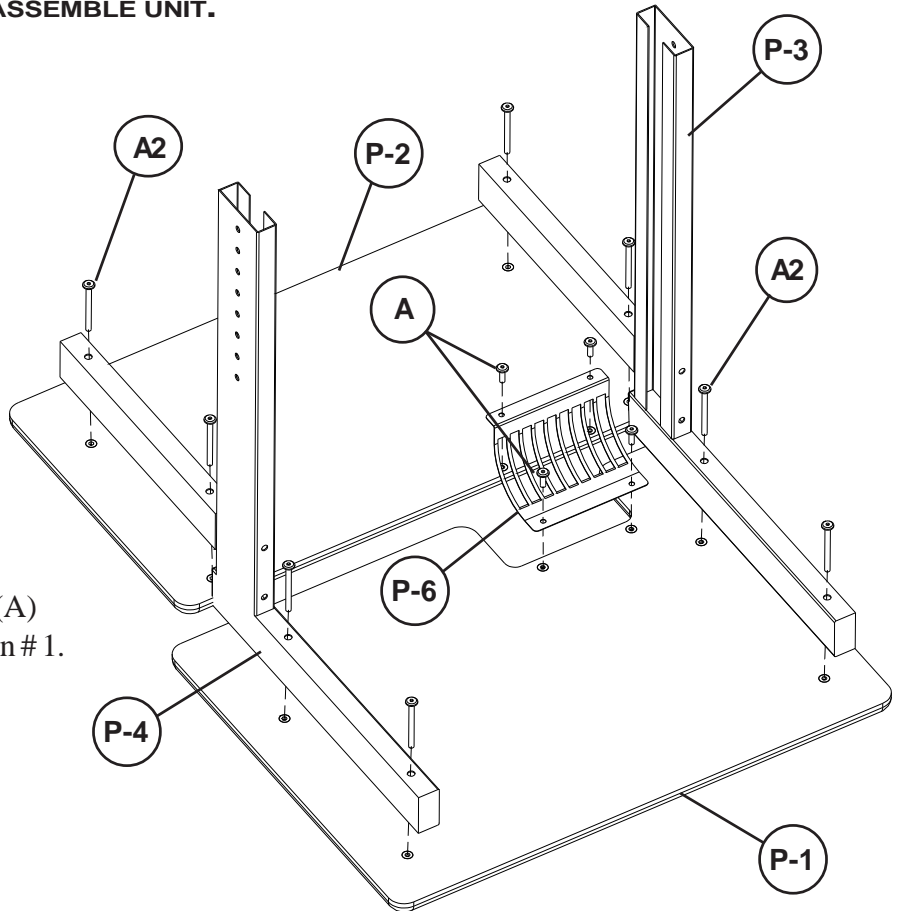

Illustration # 2

- 4.) Attach Stability Panel (P-5) to the Left upper insert and Right Upper Insert (P-4 & P-3) using 4 each (A) Screws as shown in illustration #2.

Illustration # 3

5.) Attach Right Leg Receiver (P-8) to Right Upper Insert (P-3) using 2 each (A) Screws and 2 each (C) Square nuts. Attach Left Leg Receiver (P-9) to Left Upper Insert (P-4) using 2 each (A) Screws and 2 each (C) Square nuts. (flat side of the nut should be next to the metal)

6.) Attach Accessory Shelf (P-7) to Left & Right Leg Receivers (P-9 & P-8) using 4 (A1) screws as shown in illustration # 3.

7.) Attach 2 each CPU Rods (P-11) to the Left Leg Receiver (P-9) (or Right Leg Receiver (P-8)). Secure each rod with 2 each (G) Hex nuts, 2 each (H) Flat Washers and 1 each (F) Black spacer. Slide CPU Sleeve (P-10) over ends of CPU Rods (P-12) as shown.

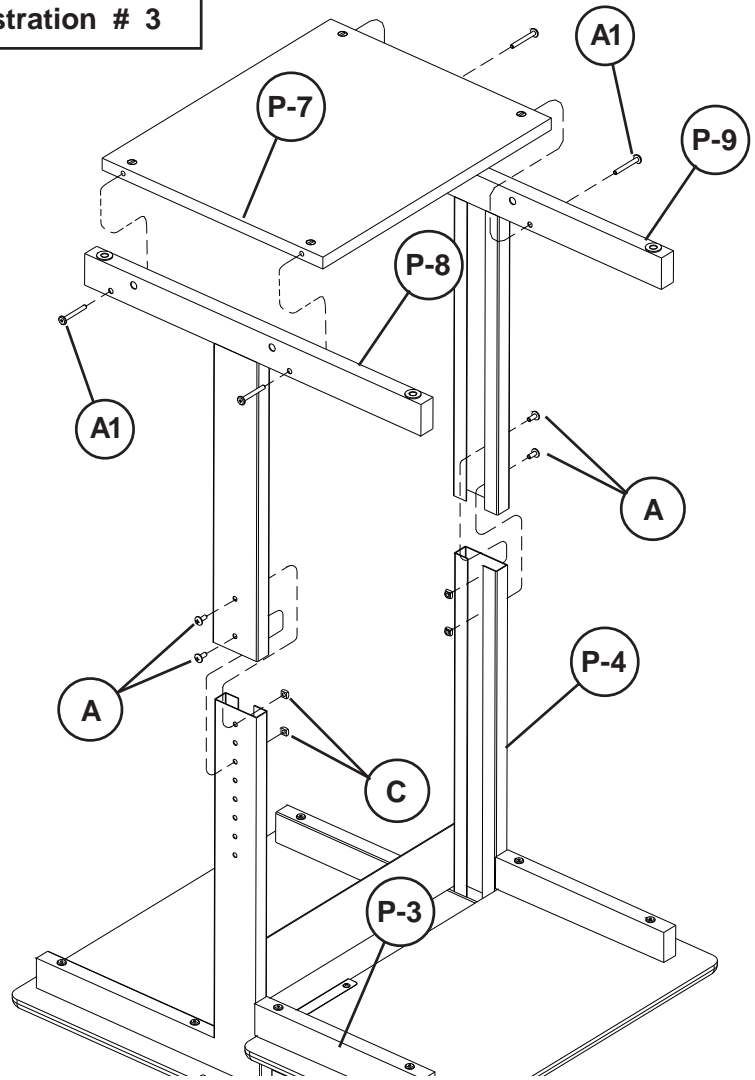
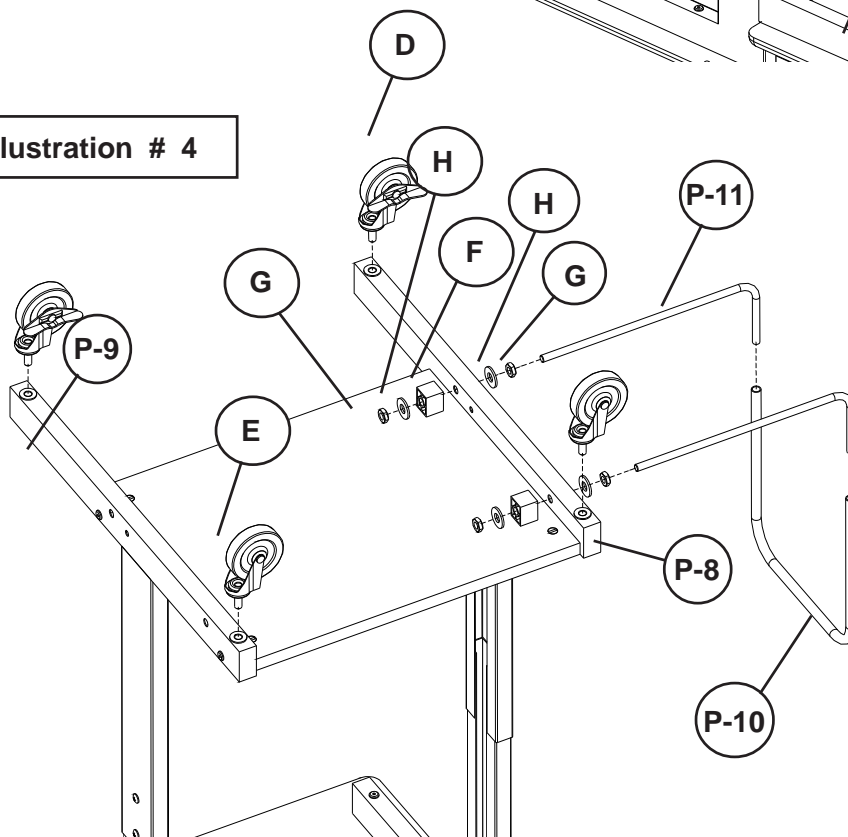

Illustration # 4



8.) Attach 2 each (D) Locking Casters to the front of the unit, and 2 each (E) Casters to the back of the unit as shown in illustration # 4. Tighten using Open End Wrench (K).

9.) Tighten all screws Securely using Allen Wrench (J).